

PF Controllers

The Intelligent Controller with extensive starting and stopping configurations up to 1000HP (3-wire), 1400HP (6-wire)



PF Control module with standard built in keypad and backlit LCD display

The PF Softstarter Controller provides intelligence, unmatched performance, flexibility, and diagnostics in a modular compact design for controlling either a standard squirrel-cage induction motor or a star-delta motor. Seven standard, and two optional modes of operation are available within a single controller.

Standard Modes of Operation

- Soft Start with selectable kick start
- Current Limit Starting
- Dual ramp start
- Full voltage starting
- Linear speed acceleration
- Preset slow speed
- Soft stop

Optional Modes of Operation

- Pump Control
- Brake Control - Smart Motor Brake, Accu-stop and Slow Speed with Braking

Product Features

- Built-in SCR Bypass/Run Contactor
- Built in Electronic Motor Overload Protection
- CT on each phase
- LCD Display
- Keypad programming
- Four programming Auxiliary Contacts

The PF Softstarter is available for motors rated 1...1,250A, 200...600V AC, 50 and 60Hz. In addition to motors, the PF Softstarter can be used to control resistive loads.

Modular and Compact Softstarter

The PF Softstarter reduces both product size and the total cost to the customer. As standard, the PF Softstarter includes electronic overload, integral bypass and motor starting capabilities for both star-delta and standard squirrel-cage induction motors, advanced protection and diagnostics in a compact maintainable modular, cost-effective package.



Large or small HP and options for any application

The basic PF Controller combines large horsepower capacity with the most popular starting modules (up to 1,000HP @ 460V, 3-wire). Even in middle and low horsepower applications, PF Softstarters can be configured to provide exactly the right starting and stopping profile (see descriptions on following pages).

Precise programming set-up with built-in keypad & LCD display

The PF Controller comes equipped with a built-in keypad and LCD display for programming the controller parameter settings for the specific industrial application. The three-line 16-character backlit LCD display provides parameter identification using clear informative text. Parameters are arranged in an organized four-level menu structure for ease of programming and fast access to parameters which allows the PF Softstarters set-up to be performed quickly and easily.

Product Overview

Modular Design

The PF Softstarter provides intelligence, unmatched performance, flexibility and diagnostics in a modular compact design for controlling either a standard squirrel-cage induction motor or a star-delta motor.

Compact Size

The PF Softstarter integrates a bypass to minimize heat generation during run time. The bypass automatically closes when the motor reaches its nominal speed, resulting in a cooler-running component and reduction in enclosure size.

Current Range - 16 Models

Product Rating	Line Current	Delta Current
5	5	9
25	25	43
43	43	74
60	60	104
85	85	147
108	108	187
135	135	234
201	201	348
251	251	435
317	317	549
361	361	625
480	480	831
625	625	850
780	780	900
970	970	1200
1250	1250	1600

Voltage Range

200...600V AC, 50/60 Hz

Control Range

100...240V AC or 24V AC/DC

Starting Modes

	PFS Standard	PFB Pump Control	PFD Braking Control
Soft Start	X	X	X
Soft Stop	X		
Current Limit	X	X	X
Full Voltage	X	X	X
Kick Start	X	X	X
Preset Slow Speed	X		X
Linear Speed Start and Stop	X		
Dual Ramp	X		
Pump Start and Stop		X	
Smart Motor Brake			X
Accu-Stop			X
Slow Speed with Braking			X

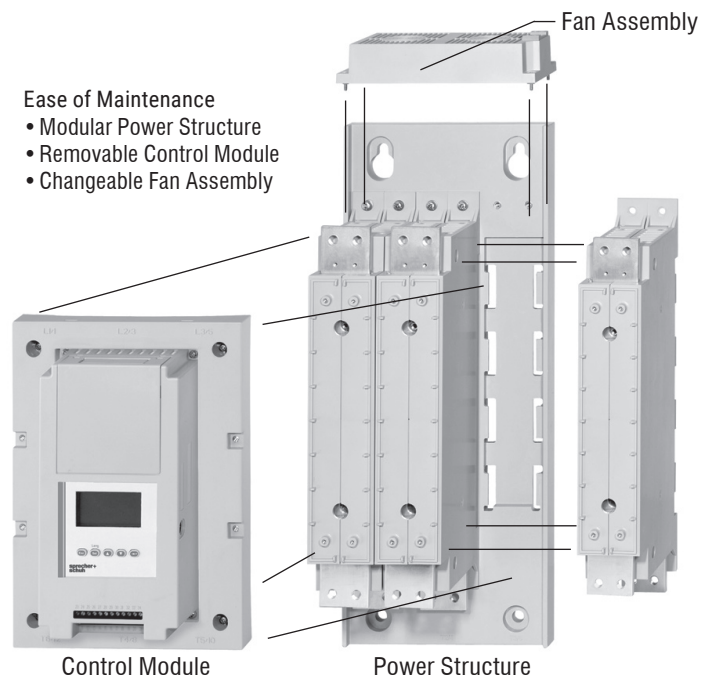
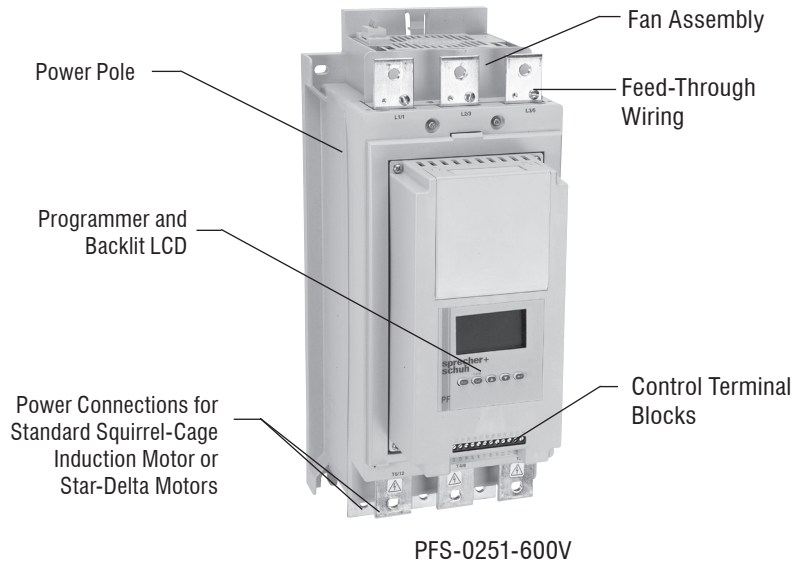

Product Features

Overload

- Flexibility in Trip Class (10,15, 20, 30, Off)
- Reset Operation (Manual or Automatic)

Diagnostics

- PTC
- Line Fault
- Voltage Imbalance
- Undervoltage
- Overtemperature
- Overload
- Ground Fault
- Power Loss
- Phase Reversal
- Overvoltage
- Open Gate
- Excessive Starts per Hour

Configurable Auxiliary Contacts - 4

- Normal, Up-to-speed, External bypass, Fault, Alarm
- N.O. or N.C.

Motor Control

- Standard Squirrel-Cage Induction Motor
- Start-Delta Motor

Metering

- Three-phase Currents
- Power in kW
- Motor Thermal
- Capacity Usage
- Elapsed Time of Motor Operation
- Three-phase voltages
- Power Usage in kWh
- Power Factor of the Running Motor

I/O

- 2 Inputs
- 4 Configurable Auxiliary Contacts

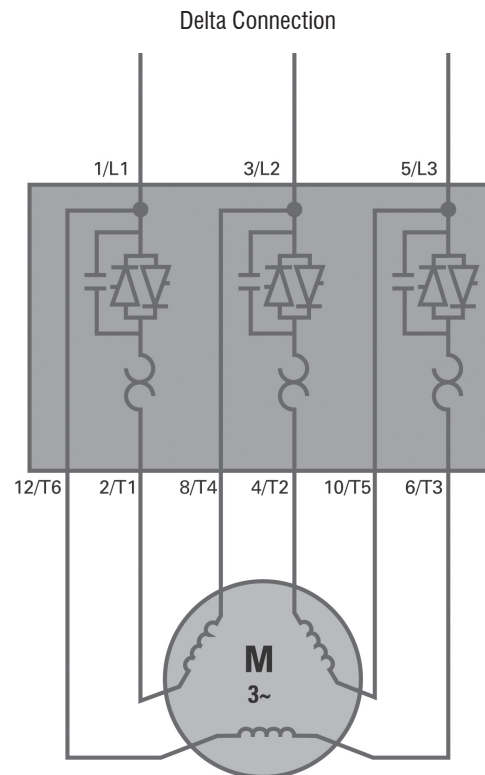
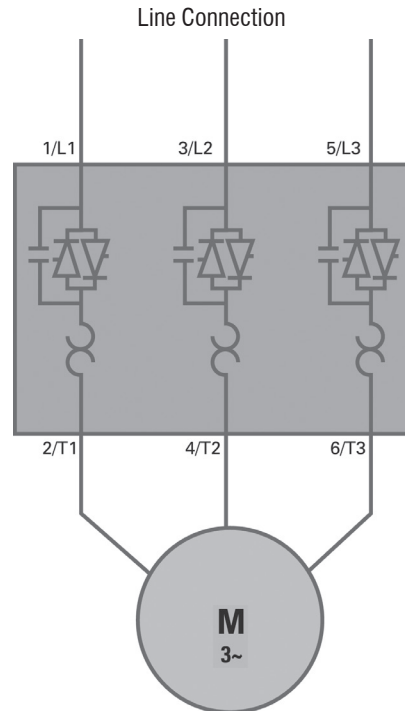

D
PFS Softstarters

Modes of Operation (Standard PFS)

D
PFS Softstarters

Soft Start

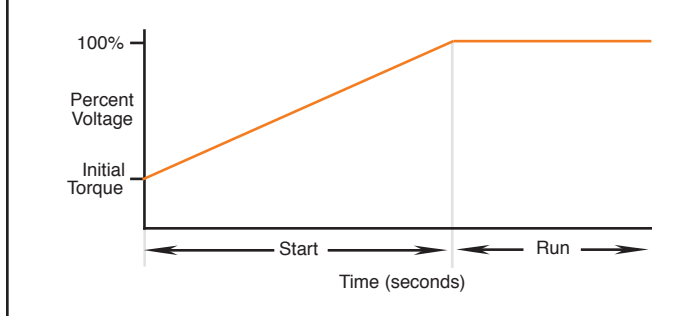

This method covers the most general applications. The motor is given an initial torque setting, which is user adjustable. From the initial torque level, the output voltage to the motor is steplessly increased during the acceleration ramp time, which is user adjustable.

Soft Start with Selectable Kickstart

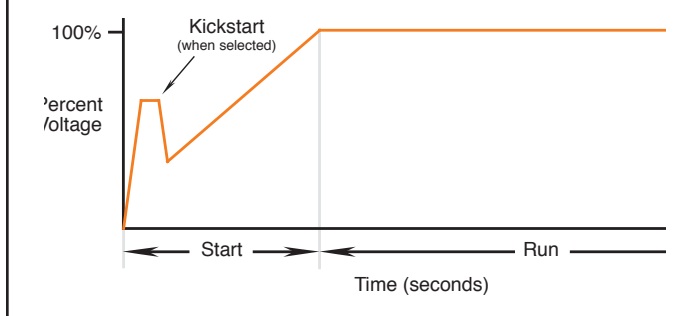

The kickstart feature provides a boost at startup to break away loads that may require a pulse of high torque to get started. It is intended to provide a current pulse, for a selected period of time.

Current Limit Starting

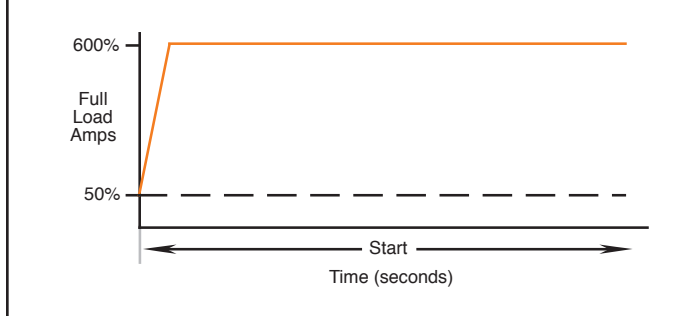

This method provides current limit start and is used when it is necessary to limit the maximum starting current. The starting current is user adjustable. The current limit starting time is user adjustable.

Dual Ramp Start

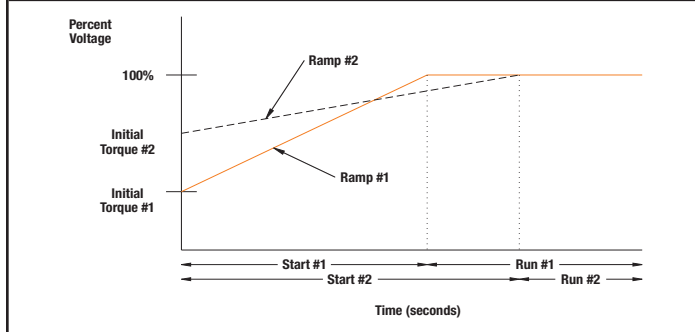

This starting method is useful on applications with varying loads, starting torque, and start time requirements. Dual Ramp Start offers the user the ability to select between two separate start profiles with separately adjustable ramp times and initial torque settings.

Modes of Operation (Standard PFS)

Full Voltage Start	
	<p>This method is used in applications requiring cross-the-line starting. The PF controller performs like a solid-state contactor. Full inrush current and locked-rotor torque are realized. The PF may be programmed to provide full voltage start in which the output voltage to the motor reaches full voltage in 1/4 second.</p>
Linear Speed Acceleration	
	<p>With this type of acceleration mode, a closed-loop feedback system maintains the motor acceleration at a constant rate. The required feedback signal is provided by a DC tachometer coupled to the motor (tachometer supplied by user 0-5V DC, 4.5V DC = 100% speed). Kickstart is available with this mode.</p>
Preset Slow Speed	
	<p>This method can be used on applications that require a slow speed for positioning material. The Preset Slow Speed can be set for either Low, 7% of base speed, or High, 15% of base speed. Reversing is also possible through programming. Speeds provided during reverse operation are Low, 10% of base speed, or High, 20% of base speed.</p>
Soft Stop ①	
	<p>The Soft Stop option can be used in applications requiring an extended stop time. The voltage ramp down time is user adjustable from 0 to 120 seconds. The load will stop when the voltage drops to a point where the load torque is greater than the motor torque.</p>

D
PFS Softstarters

① Not intended to be used as an emergency stop. Refer to the applicable standards for emergency stop requirements.

Optional Modes of Operation

D
PFS Softstarters

Pump Control - Start and Stop (Option "PFB") ①

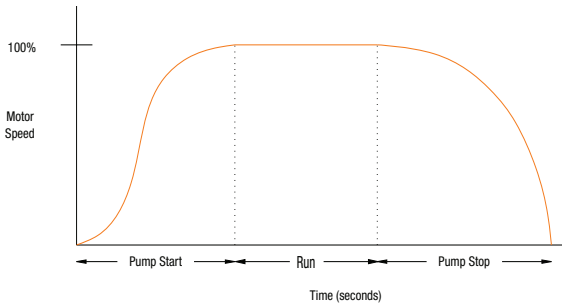

This option is used to reduce surges during the starting and stopping of a centrifugal pump by smoothly accelerating and decelerating the motor. The microprocessor analyzes the motor variables and generates commands which control the motor and reduce the possibility of surges occurring in the system. The pump control module also provides a built-in anti-backspin timer.

Smart Motor Brake (Option "PFD") ①

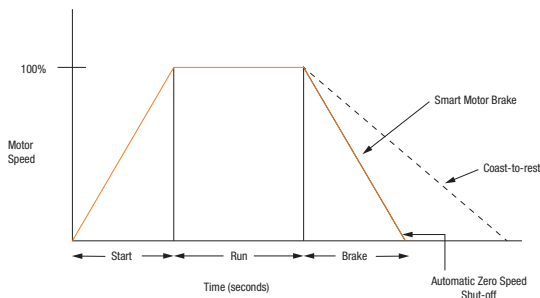

This option provides motor braking for applications that require the motor to stop faster than a coast to rest. Braking control, with automatic zero speed shut off, is fully integrated into the compact design of the PF controller. This design facilitates a clean, straight forward installation and eliminates the requirement for additional hardware such as braking contactors, resistors, timers, and speed sensors. The microprocessor based braking system applies braking current to a standard squirrel-cage induction motor. The strength of the braking current is programmable from 150...400% of full-load current.

Accu-Stop (Option "PFD") ①

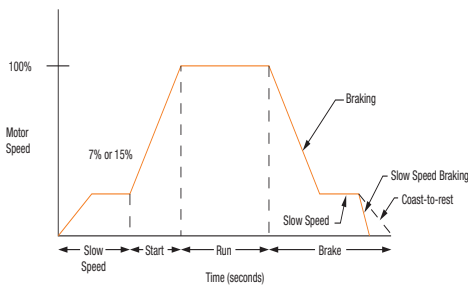

This option is used in applications requiring controlled position stopping. During stopping, braking torque is applied to the motor until it reaches preset slow speed (7% or 15% of rated speed) and holds the motor at this speed until a stop command is given. Braking torque is then applied until the motor reaches zero speed. Braking current is programmable from 0...400% of full-load current. Slow Speed Current is programmable from 0...450% of full-load current. Slow speed can be programmed for either 7% (low) or 15% (high).

Slow Speed with Braking (Option "PFD") ①

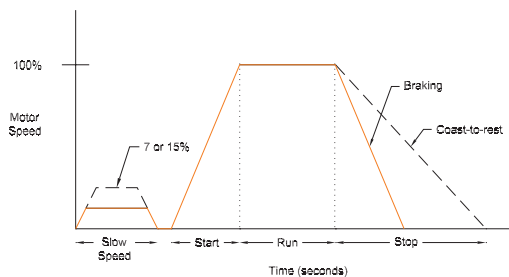

Slow Speed with Braking is used on applications that require slow speed (in the forward direction) for positioning or alignment and also require braking control to stop. Slow speed adjustments are 7% (low) or 15% (high) of rated speed. Slow speed acceleration current is adjustable from 0...450%. Slow speed running current is adjustable from 0...450% of full-load current. Braking current is adjustable from 0...400%.

① Not intended to be used as an emergency stop. Refer to the applicable standards for emergency stop requirements.

Description of Features

Electronic Motor Overload Protection

The PF Softstarter controller incorporates, as standard, electronic motor overload protection. This overload protection is accomplished electronically with an I^2t algorithm. When coordinated with the proper short circuit protection, overload protection is intended to protect the motor, motor controller, and power wiring against overheating caused by excessive overcurrent. The PF Softstarter controller meets applicable requirements as a motor overload protective device. The controller's overload protection is programmable, providing the user with flexibility. The overload trip class consists of either OFF, 10, 15, 20 or 30 protection. The trip current is programmed by entering the motor full-load current rating, service factor, and selecting the trip class. Thermal memory is included to accurately model motor operating temperature. Ambient insensitivity is inherent in the electronic design of the overload.

Stall Protection and Jam Detection

Motors can experience locked-rotor currents and develop high torque levels in the event of a stall or a jam. These conditions can result in winding insulation breakdown or mechanical damage to the connected load. The PF Softstarter controller provides both stall protection and jam detection for enhanced motor and system protection. Stall protection allows the user to program a maximum stall protection delay time from 0...10 seconds. The stall protection delay time is in addition to the programmed start time and begins only after the start time has timed out. If the controller senses that the motor is stalled, it will shut down after the delay period has expired. Jam detection allows the user to determine the motor jam detection level as a percentage of the motor's full-load current rating. To prevent nuisance tripping, a jam detection delay time, from 0.0...99.0 seconds, can be programmed. This allows the user to select the time delay required before the PF Softstarter controller will trip on a motor jam condition. The motor current must remain above the jam detection level during the delay time. Jam detection is active only after the motor has reached full speed.

Underload Protection

Utilizing the underload protection of the PF Softstarter controller, motor operation can be halted if a drop in current is sensed. The PF Softstarter controller provides an adjustable underload trip setting from 0...99% of the programmed motor full-load current rating with an adjustable trip delay time of 0...99 seconds.

Undervoltage Protection

The PF Softstarter controller's undervoltage protection will halt motor operation if a drop in the incoming line voltage is detected. The undervoltage trip level is adjustable as a percentage of the programmed line voltage, from 0...99%. To eliminate nuisance trips, a programmable undervoltage trip delay time of 0...99 seconds can also be programmed. The line voltage must remain below the undervoltage trip level during the programmed delay time.

Overvoltage Protection

If a rise in the incoming line voltage is detected, the PF Softstarter controller's overvoltage protection will halt motor operation. The overvoltage trip level is adjustable as a percentage of the programmed line voltage, from 0...199%. To eliminate nuisance trips, a programmable overvoltage trip delay time of 0...99 seconds can also be programmed. The line voltage must remain above the overvoltage trip level during the programmed delay time.

Voltage Unbalance Protection

Voltage unbalance is detected by monitoring the 3-phase supply voltage

magnitudes in conjunction with the rotational relationship of the three phases. The controller will halt motor operation when the calculated voltage unbalance reaches the user-programmed trip level. The voltage unbalance trip level is programmable from 0...25% unbalance.

Excessive Starts Per Hour

The PF Softstarter controller allows the user to program the allowed number of starts per hour (up to 99). This helps eliminate motor stress caused by repeated starting during a short time period.

Metering

Power monitoring parameters include:

- 3-phase current
- 3-phase voltage
- Power in kW
- Power usage in kWh
- Power factor
- Motor thermal capacity usage
- Elapsed time

Note: The motor thermal capacity usage allows the user to monitor the amount of overload thermal capacity usage before the PF Softstarter controller's built-in electronic overload trips.

LCD Display

The PF Softstarter controller's three-line 16-character backlit LCD display provides parameter identification using clear, informative text. Controller set up can be performed quickly and easily without the use of a reference manual. Parameters are arranged in an organized four-level menu structure for ease of programming and fast access to parameters.

Keypad Programming

Programming of parameters is accomplished through a five-button keypad on the front of the PF Softstarter controller. The five buttons include up and down arrows, an Enter button, a Select button, and an Escape button. The user needs only to enter the correct sequence of keystrokes for programming the PF Softstarter controller.

Auxiliary Contacts

Four fully programmable hard contacts are furnished as standard with the PF Softstarter controller:

Aux #1, Aux #2, Aux #3, Aux #4:

- N.O./N.C.
- Normal/Up-to-Speed/External Bypass/Fault/Alarm

Ground Fault Input

The PF Softstarter can monitor for ground fault conditions. An external core balance current transformer is required for this function.

Tach Input

A motor tachometer is required for the Linear Speed Start mode. Please see the Specifications section page D49 for tachometer characteristics.

PTC Input

A motor PTC input can be monitored by the PF Softstarter. In the event of a fault, the PF Softstarter will shut down and indicate a motor PTC fault.

Open Type Controller - Line Connected ①⑤

Rated Voltage [V AC]	Motor Current (Amps) ②	Max. kW 50 Hz	Max. Hp 60 Hz ③	100...240V AC 50/60Hz	24V AC/DC
				Control Voltage ④	Control Voltage ④
				Catalog Number	Catalog Number
200/208	1...5	~	1	PFS-0005-600V	PFS-0005-600V-024
	5...25	~	5	PFS-0025-600V	PFS-0025-600V-024
	8.6...43	~	10	PFS-0043-600V	PFS-0043-600V-024
	12...60	~	15	PFS-0060-600V	PFS-0060-600V-024
	17...85	~	25	PFS-0085-600V	PFS-0085-600V-024
	27...108	~	30	PFS-0108-600V	PFS-0108-600V-024
	34...135	~	40	PFS-0135-600V	PFS-0135-600V-024
	67...201	~	60	PFS-0201-600V	PFS-0201-600V-024
	84...251	~	75	PFS-0251-600V	PFS-0251-600V-024
	106...317	~	100	PFS-0317-600V	PFS-0317-600V-024
	120...361	~	125	PFS-0361-600V	PFS-0361-600V-024
	160...480	~	150	PFS-0480-600V	PFS-0480-600V-024
	208...625	~	200	PFS-0625-600V-120 ⑥	~
	260...780	~	250	PFS-0780-600V-120 ⑥	~
323...970	~	350	PFS-0970-600V-120 ⑥	~	
416...1250	~	400	PFS-1250-600V-120 ⑥	~	
230	1...5	1.1	1	PFS-0005-600V	PFS-0005-600V-024
	5...25	5.5	7.5	PFS-0025-600V	PFS-0025-600V-024
	8.6...43	11	15	PFS-0043-600V	PFS-0043-600V-024
	12...60	15	20	PFS-0060-600V	PFS-0060-600V-024
	17...85	22	30	PFS-0085-600V	PFS-0085-600V-024
	27...108	30	40	PFS-0108-600V	PFS-0108-600V-024
	34...135	37	50	PFS-0135-600V	PFS-0135-600V-024
	67...201	55	75	PFS-0201-600V	PFS-0201-600V-024
	84...251	75	100	PFS-0251-600V	PFS-0251-600V-024
	106...317	90	125	PFS-0317-600V	PFS-0317-600V-024
	120...361	110	150	PFS-0361-600V	PFS-0361-600V-024
	160...480	132	200	PFS-0480-600V	PFS-0480-600V-024
	208...625	200	250	PFS-0625-600V-120 ⑥	~
	260...780	250	300	PFS-0780-600V-120 ⑥	~
323...970	315	400	PFS-0970-600V-120 ⑥	~	
416...1250	400	500	PFS-1250-600V-120 ⑥	~	

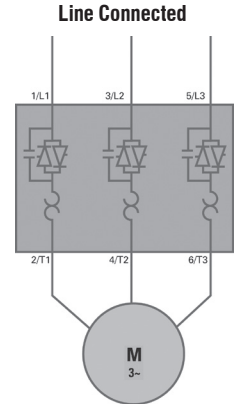

D PFS Softstarters

- ① Controllers rated 108 A and greater are not equipped with line and load terminal lugs. See page D49 for terminal lug kits.
- ② Motor FLA rating must fall within specified current range for unit to operate properly. Special consideration should be given when using a motor with a potentially high starting current (greater than ten times motor FLA) with the PF in the "Full Voltage" starting mode. Contact Sprecher+Schuh technical support for further guidance.

- ③ Hp ratings at motor terminal voltages for 200, 230, 460, and 575 line volts, respectively.
- ④ Separate 120V or 240V single phase is required for PF fan operation.
- ⑤ See page D48 if ordering factory installed PFB Pump Control or PFD Smart Motor Bake Control Modules, or other options.
- ⑥ 110/120V control power only. For 230V control power only, change catalog number suffix "-120" to "-230".

Open Type Controller - Line Connected ①⑤

Rated Voltage [V AC]	Motor Current (Amps) ②	Max. kW 50 Hz	Max. Hp 60 Hz ③	100...240V AC 50/60Hz Control Voltage ④	24V AC/DC Control Voltage ④
				Catalog Number	Catalog Number
400/415/460	1...5	2.2	3	PFS-0005-600V	PFS-0005-600V-024
	5...25	11	15	PFS-0025-600V	PFS-0025-600V-024
	8.6...43	22	30	PFS-0043-600V	PFS-0043-600V-024
	12...60	30	40	PFS-0060-600V	PFS-0060-600V-024
	17...85	45	60	PFS-0085-600V	PFS-0085-600V-024
	27...108	55	75	PFS-0108-600V	PFS-0108-600V-024
	34...135	75	100	PFS-0135-600V	PFS-0135-600V-024
	67...201	110	150	PFS-0201-600V	PFS-0201-600V-024
	84...251	132	200	PFS-0251-600V	PFS-0251-600V-024
	106...317	160	250	PFS-0317-600V	PFS-0317-600V-024
	120...361	200	300	PFS-0361-600V	PFS-0361-600V-024
	160...480	250	400	PFS-0480-600V	PFS-0480-600V-024
	208...625	355	500	PFS-0625-600V-120 ⑥	~
	260...780	450	600	PFS-0780-600V-120 ⑥	~
	323...970	560	800	PFS-0970-600V-120 ⑥	~
416...1250	710	1000	PFS-1250-600V-120 ⑥	~	
500/575	1...5	2.2	3	PFS-0005-600V	PFS-0005-600V-024
	5...25	15	20	PFS-0025-600V	PFS-0025-600V-024
	8.6...43	22	40	PFS-0043-600V	PFS-0043-600V-024
	12...60	37	50	PFS-0060-600V	PFS-0060-600V-024
	17...85	55	75	PFS-0085-600V	PFS-0085-600V-024
	27...108	75	100	PFS-0108-600V	PFS-0108-600V-024
	34...135	90	125	PFS-0135-600V	PFS-0135-600V-024
	67...201	132	200	PFS-0201-600V	PFS-0201-600V-024
	84...251	160	250	PFS-0251-600V	PFS-0251-600V-024
	160...317	200	300	PFS-0317-600V	PFS-0317-600V-024
	120...361	250	350	PFS-0361-600V	PFS-0361-600V-024
	160...480	315	500	PFS-0480-600V	PFS-0480-600V-024
	208...625	450	600	PFS-0625-600V-120 ⑥	~
	260...480	560	800	PFS-0780-600V-120 ⑥	~
	323...970	710	1000	PFS-0970-600V-120 ⑥	~
416...1250	900	1300	PFS-1250-600V-120 ⑥	~	

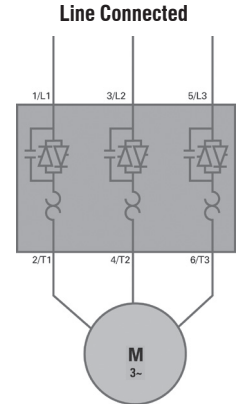

D
PFS Softstarters

- ① Controllers rated 108 A and greater are not equipped with line and load terminal lugs. See page D49 for terminal lug kits.
- ② Motor FLA rating must fall within specified current range for unit to operate properly. Special consideration should be given when using a motor with a potentially high starting current (greater than ten times motor FLA) with the PF in the "Full Voltage" starting mode. Contact Sprecher+Schuh technical support for further guidance.

- ③ Hp ratings at motor terminal voltages for 200, 230, 460, and 575 line volts, respectively.
- ④ Separate 120V or 240V single phase is required for PF fan operation.
- ⑤ See page D48 if ordering factory installed PFB Pump Control or PFD Smart Motor Bake Control Modules, or other options.
- ⑥ 110/120V control power only. For 230V control power only, change catalog number suffix "-120" to "-230".

Open Type Controller - Delta Connected ①②⑦

Rated Voltage [V AC]	Motor Current (Amps) ④	Max. kW 50 Hz	Max. Hp 60 Hz ⑤	100...240V AC 50/60Hz	24V AC/DC
				Control Voltage ⑥	Control Voltage ⑥
				Catalog Number	Catalog Number
200/208	1.7...8.7	~	2	PFS-0005-600V	PFS-0005-600V-024
	8.7...43	~	10	PFS-0025-600V	PFS-0025-600V-024
	14.9...74	~	20	PFS-0043-600V	PFS-0043-600V-024
	20.8...104	~	30	PFS-0060-600V	PFS-0060-600V-024
	29.4...147	~	40	PFS-0085-600V	PFS-0085-600V-024
	47...187	~	60	PFS-0108-600V	PFS-0108-600V-024
	59...234	~	75	PFS-0135-600V	PFS-0135-600V-024
	116...348	~	100	PFS-0201-600V	PFS-0201-600V-024
	145...435	~	150	PFS-0251-600V	PFS-0251-600V-024
	183...549	~	200	PFS-0317-600V	PFS-0317-600V-024
	208...625	~	200	PFS-0361-600V	PFS-0361-600V-024
	277...831	~	300	PFS-0480-600V	PFS-0480-600V-024
	283...850	~	300	PFS-0625-600V-120 ⑥	~
	300...900	~	300	PFS-0780-600V-120 ⑥	~
400...1200	~	400	PFS-0970-600V-120 ⑥	~	
533...1600	~	500	PFS-1250-600V-120 ⑥	~	
230	1.7...8.7	2.2	2	PFS-0005-600V	PFS-0005-600V-024
	8.7...43	11	15	PFS-0025-600V	PFS-0025-600V-024
	14.9...74	22	25	PFS-0043-600V	PFS-0043-600V-024
	20.8...104	30	40	PFS-0060-600V	PFS-0060-600V-024
	29.4...147	45	50	PFS-0085-600V	PFS-0085-600V-024
	47...187	55	60	PFS-0108-600V	PFS-0108-600V-024
	59...234	75	75	PFS-0135-600V	PFS-0135-600V-024
	116...348	110	125	PFS-0201-600V	PFS-0201-600V-024
	145...435	132	150	PFS-0251-600V	PFS-0251-600V-024
	183...549	160	200	PFS-0317-600V	PFS-0317-600V-024
	208...625	200	250	PFS-0361-600V	PFS-0361-600V-024
	277...831	250	350	PFS-0480-600V	PFS-0480-600V-024
	283...850	250	350	PFS-0625-600V-120 ⑥	~
	300...900	250	350	PFS-0780-600V-120 ⑥	~
400...1200	400	400	PFS-0970-600V-120 ⑥	~	
533...1600	500	600	PFS-1250-600V-120 ⑥	~	

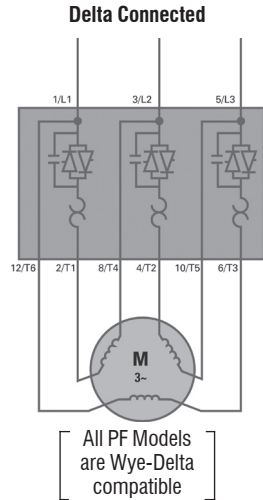

- ① Controllers rated 108 A and greater are not equipped with line and load terminal lugs. See page D49 for terminal lug kits.
- ② See page D48 if ordering factory installed PFB Pump Control or PFD Smart Motor Bake Control Modules, or other options.
- ③ Hp ratings at motor terminal voltages for 200, 230, 460, and 575 line volts, respectively.
- ④ Motor FLA rating must fall within specified current range for unit to operate properly. Special consideration should be given when using a motor with a potentially high starting current (greater than ten times motor FLA) with the PF in the "Full Voltage" starting mode. Contact Sprecher+Schuh technical support for further guidance.

- ⑤ Separate 120V or 240V single phase is required for PF fan operation.
- ⑥ 110/120V control power only. For 230V control power only, change catalog number suffix "-120" to "-230".
- ⑦ It is recommended that an isolation contactor be added to the circuit to provide galvanic isolation of the motor and final electromechanical removal of power.

Open Type Controller - Delta Connected ①②⑦

Rated Voltage [V AC]	Motor Current (Amps) ②	Max. kW 50 Hz	Max. Hp 60 Hz ③	100...240V AC 50/60Hz Control Voltage ⑤	24V AC/DC Control Voltage ⑤
				Catalog Number	Catalog Number
460	1.7...8.7	4	5	PFS-0005-600V	PFS-0005-600V-024
	8.7...43	22	30	PFS-0025-600V	PFS-0025-600V-024
	14.9...74	37	50	PFS-0043-600V	PFS-0043-600V-024
	20.8...104	55	75	PFS-0060-600V	PFS-0060-600V-024
	29.4...147	75	100	PFS-0085-600V	PFS-0085-600V-024
	47...187	90	150	PFS-0108-600V	PFS-0108-600V-024
	59...234	132	150	PFS-0135-600V	PFS-0135-600V-024
	116...348	160	250	PFS-0201-600V	PFS-0201-600V-024
	145...435	250	350	PFS-0251-600V	PFS-0251-600V-024
	183...549	315	450	PFS-0317-600V	PFS-0317-600V-024
	208...625	355	500	PFS-0361-600V	PFS-0361-600V-024
	277...831	450	700	PFS-0480-600V	PFS-0480-600V-024
	283...850	500	700	PFS-0625-600V-120 ⑥	~
	300...900	500	700	PFS-0780-600V-120 ⑥	~
400...1200	710	1000	PFS-0970-600V-120 ⑥	~	
530...1600	900	1400	PFS-1250-600V-120 ⑥	~	
500/575	1.7...8.7	5.5	7.5	PFS-0005-600V	PFS-0005-600V-024
	8.7...43	15	40	PFS-0025-600V	PFS-0025-600V-024
	14.9...74	45	60	PFS-0043-600V	PFS-0043-600V-024
	20.8...104	55	100	PFS-0060-600V	PFS-0060-600V-024
	29.4...147	90	150	PFS-0085-600V	PFS-0085-600V-024
	47...187	132	150	PFS-0108-600V	PFS-0108-600V-024
	59...234	160	200	PFS-0135-600V	PFS-0135-600V-024
	116...348	250	350	PFS-0201-600V	PFS-0201-600V-024
	145...435	315	400	PFS-0251-600V	PFS-0251-600V-024
	183...549	400	500	PFS-0317-600V	PFS-0317-600V-024
	208...625	450	600	PFS-0361-600V	PFS-0361-600V-024
	277...831	560	900	PFS-0480-600V	PFS-0480-600V-024
	283...850	560	900	PFS-0625-600V-120 ⑥	~
	300...900	630	900	PFS-0780-600V-120 ⑥	~
400...1200	800	1300	PFS-0970-600V-120 ⑥	~	
533...1600	1100	1600	PFS-1250-600V-120 ⑥	~	

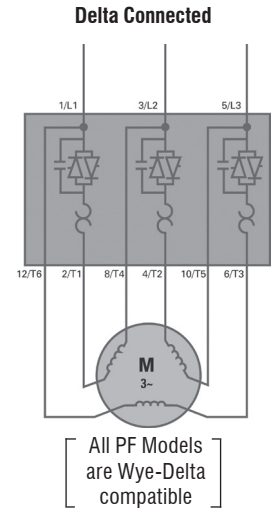

D
PFS Softstarters

- ① Controllers rated 108 A and greater are not equipped with line and load terminal lugs. See page D49 for terminal lug kits.
- ② See page D48 if ordering factory installed PFB Pump Control or PFD Smart Motor Bake Control Modules, or other options.
- ③ Hp ratings at motor terminal voltages for 200, 230, 460, and 575 line volts, respectively.
- ④ Motor FLA rating must fall within specified current range for unit to operate properly. Special consideration should be given when using a motor with a potentially high starting current (greater than ten times motor FLA) with the PF in the "Full Voltage" starting mode. Contact Sprecher+Schuh technical support for further guidance.

- ⑤ Separate 120V or 240V single phase is required for PF fan operation.
- ⑥ 110/120V control power only. For 230V control power only, change catalog number suffix "-120" to "-230". Price remains the same.
- ⑦ It is recommended that an isolation contactor be added to the circuit to provide galvanic isolation of the motor and final electromechanical removal of power.

Enclosed Non-Combination Starters - Line Connected ②③④

Rated Voltage [V AC]	Motor Current (Amps) ①	kW 50 Hz	Hp 60 Hz	Type 12 [Type 3R ⑤] Industrial Dust-tight		Type 4 Watertight	
				Catalog Number	Price	Catalog Number	Price
200/208	1...5	—	1	PFS-0005-NHDD		PFS-0005-NHDW	
	5...25	—	5	PFS-0025-NHDD		PFS-0025-NHDW	
	8.6...43	—	10	PFS-0043-NHDD		PFS-0043-NHDW	
	12...60	—	15	PFS-0060-NHDD		PFS-0060-NHDW	
	17...85	—	25	PFS-0085-NHDD		PFS-0085-NHDW	
	27...108	—	30	PFS-0108-NHDD		PFS-0108-NHDW	
	34...135	—	40	PFS-0135-NHDD		PFS-0135-NHDW	
	67...201	—	60	PFS-0201-NHDD		PFS-0201-NHDW	
	84...251	—	75	PFS-0251-NHDD		PFS-0251-NHDW	
	106...317	—	100	PFS-0317-NHDD		PFS-0317-NHDW	
	120...361	—	125	PFS-0361-NHDD		PFS-0361-NHDW	
	160...480	—	150	PFS-0480-NHDD		PFS-0480-NHDW	
	208...625	—	200	PFS-0625-NHDD		PFS-0625-NHDW	
	260...780	—	250	PFS-0780-NHDD		PFS-0780-NHDW	
323...970	—	350	PFS-0970-NHDD		PFS-0970-NHDW		
416...1250	—	400	PFS-1250-NHDD		PFS-1250-NHDW		
230	1...5	1.1	1	PFS-0005-NADD		PFS-0005-NADW	
	5...25	5.5	7.5	PFS-0025-NADD		PFS-0025-NADW	
	8.6...43	11	15	PFS-0043-NADD		PFS-0043-NADW	
	12...60	15	20	PFS-0060-NADD		PFS-0060-NADW	
	17...85	22	30	PFS-0085-NADD		PFS-0085-NADW	
	27...108	30	40	PFS-0108-NADD		PFS-0108-NADW	
	34...135	37	50	PFS-0135-NADD		PFS-0135-NADW	
	67...201	55	75	PFS-0201-NADD		PFS-0201-NADW	
	84...251	75	100	PFS-0251-NADD		PFS-0251-NADW	
	106...317	90	125	PFS-0317-NADD		PFS-0317-NADW	
	120...361	110	150	PFS-0361-NADD		PFS-0361-NADW	
	160...480	132	200	PFS-0480-NADD		PFS-0480-NADW	
	208...625	200	250	PFS-0625-NADD		PFS-0625-NADW	
	260...780	250	300	PFS-0780-NADD		PFS-0780-NADW	
323...970	315	400	PFS-0970-NADD		PFS-0970-NADW		
416...1250	400	500	PFS-1250-NADD		PFS-1250-NADW		

Non-Combination PF Softstarters include:

- A 120V control power transformer with fused primary and secondary
- PF built-in electronic motor overload protection
- PF built-in SCR bypass/run contactor
- Available in UL Type 12 or 4 Enclosures
- Terminal blocks for remote control devices

D PFS Softstarters

① Motor FLA rating must fall within specified current range for unit to operate properly. Special consideration should be given when using a motor with a potentially high starting current (greater than ten times motor FLA) with the PF in the "Full Voltage" starting mode. Contact Sprecher+Schuh technical support for further guidance.

② Line and load termination are provided as standard.

③ See page D48 if ordering factory installed PFB Pump Control or PFD Smart Motor Bake Control Modules, or other options.

④ Other UL type enclosures available. Ask your Sprecher + Schuh representative.

⑤ For outdoor applications, replace "D" in catalog number with an "R". All enclosures are Type-12 with a Drip Shield. Example: PFS-0085-NHDD becomes PFS-0085-NHDR.

Enclosed Non-Combination Starters - Line Connected ②③④

Rated Voltage [V AC]	Motor Current (Amps) ①	kW 50 Hz	Hp 60 Hz	Type 12 [Type 3R ⑤] Industrial Dust-tight		Type 4 Watertight	
				Catalog Number	Price	Catalog Number	Price
460 ⑥	1...5	2.2	3	PFS-0005-NBDD		PFS-0005-NBDW	
	5...25	11	15	PFS-0025-NBDD		PFS-0025-NBDW	
	8.6...43	22	30	PFS-0043-NBDD		PFS-0043-NBDW	
	12...60	30	40	PFS-0060-NBDD		PFS-0060-NBDW	
	17...85	45	60	PFS-0085-NBDD		PFS-0085-NBDW	
	27...108	55	75	PFS-0108-NBDD		PFS-0108-NBDW	
	34...135	75	100	PFS-0135-NBDD		PFS-0135-NBDW	
	67...201	110	150	PFS-0201-NBDD		PFS-0201-NBDW	
	84...251	132	200	PFS-0251-NBDD		PFS-0251-NBDW	
	106...317	160	250	PFS-0317-NBDD		PFS-0317-NBDW	
	120...361	200	300	PFS-0361-NBDD		PFS-0361-NBDW	
	160...480	250	400	PFS-0480-NBDD		PFS-0480-NBDW	
	208...625	355	500	PFS-0625-NBDD		PFS-0625-NBDW	
	260...780	450	600	PFS-0780-NBDD		PFS-0780-NBDW	
323...970	560	800	PFS-0970-NBDD		PFS-0970-NBDW		
416...1250	710	1000	PFS-1250-NBDD		PFS-1250-NBDW		
500/575	1...5	2.2	3	PFS-0005-NCDD		PFS-0005-NCDW	
	5...25	15	20	PFS-0025-NCDD		PFS-0025-NCDW	
	8.6...43	22	40	PFS-0043-NCDD		PFS-0043-NCDW	
	12...60	37	50	PFS-0060-NCDD		PFS-0060-NCDW	
	17...85	55	75	PFS-0085-NCDD		PFS-0085-NCDW	
	27...108	75	100	PFS-0108-NCDD		PFS-0108-NCDW	
	34...135	90	125	PFS-0135-NCDD		PFS-0135-NCDW	
	67...201	132	200	PFS-0201-NCDD		PFS-0201-NCDW	
	84...251	160	250	PFS-0251-NCDD		PFS-0251-NCDW	
	106...317	200	300	PFS-0317-NCDD		PFS-0317-NCDW	
	120...361	250	350	PFS-0361-NCDD		PFS-0361-NCDW	
	160...480	315	500	PFS-0480-NCDD		PFS-0480-NCDW	
	208...625	450	600	PFS-0625-NCDD		PFS-0625-NCDW	
	260...780	560	800	PFS-0780-NCDD		PFS-0780-NCDW	
323...970	710	1000	PFS-0970-NCDD		PFS-0970-NCDW		
416...1250	900	1300	PFS-1250-NCDD		PFS-1250-NCDW		

Non-Combination PF Softstarters include:

- A 120V control power transformer with fused primary and secondary
- PF built-in electronic motor overload protection
- PF built-in SCR bypass/run contactor
- Available in UL Type 12 or 4 Enclosures
- Terminal blocks for remote control devices

D
PFS Softstarters

- ① Motor FLA rating must fall within specified current range for unit to operate properly. Special consideration should be given when using a motor with a potentially high starting current (greater than ten times motor FLA) with the PF in the "Full Voltage" starting mode. Contact Sprecher+Schuh technical support for further guidance.
- ② Line and load termination are provided as standard.
- ③ See page D48 if ordering factory installed PFB Pump Control or PFD Smart Motor Bake Control Modules, or other options.
- ④ Other UL type enclosures available. Ask your Sprecher + Schuh representative.

- ⑤ For 380V applications choose softstarter based on FLA, then change the NB code in the catalog number to NG. For example PFS-0085-NBDD becomes PFS-0085-NGDD, which covers 25 HP @ 380V FLA 37. Price remains the same.
- ⑥ For outdoor applications, replace "D" in catalog number with an "R". All enclosures are Type-12 with a Drip Shield. Example: PFS-0085-NBDD becomes PFS-0085-NBDR. Price and dimensions remain the same.

Enclosed Combination Circuit Breaker - Line Connected ①②④

Rated Voltage [V AC]	kW 50 Hz	Hp 60 Hz	Controller Current Rating ③	Type 12 [Type 3R ④] Industrial Dusttight Catalog Number	Type 4 Watertight Catalog Number
200	—	0.5	5 A	PFS-0005-BHD33D	PFS-0005-BHD33W
	—	0.75	5 A	PFS-0005-BHD34D	PFS-0005-BHD34W
	—	1	5 A	PFS-0005-BHD35D	PFS-0005-BHD35W
	—	1.5	25 A	PFS-0025-BHD36D	PFS-0025-BHD36W
	—	2	25 A	PFS-0025-BHD37D	PFS-0025-BHD37W
	—	3	25 A	PFS-0025-BHD38D	PFS-0025-BHD38W
	—	5	25 A	PFS-0025-BHD39D	PFS-0025-BHD39W
	—	5	25 A	PFS-0025-BHD40D	PFS-0025-BHD40W
	—	10	43 A	PFS-0043-BHD41D	PFS-0043-BHD41W
	—	15	60 A	PFS-0060-BHD42D	PFS-0060-BHD42W
	—	20	85 A	PFS-0085-BHD43D	PFS-0085-BHD43W
	—	25	85 A	PFS-0085-BHD44D	PFS-0085-BHD44W
	—	30	108 A	PFS-0108-BHD45D	PFS-0108-BHD45W
	—	40	135 A	PFS-0135-BHD46D	PFS-0135-BHD46W
	—	50	201 A	PFS-0201-BHD47D	PFS-0201-BHD47W
	—	60	201 A	PFS-0201-BHD48D	PFS-0201-BHD48W
	—	75	251 A	PFS-0251-BHD49D	PFS-0251-BHD49W
	—	100	317 A	PFS-0317-BHD50D	PFS-0317-BHD50W
—	125	361 A	PFS-0361-BHD51D	PFS-0361-BHD51W	
—	150	480 A	PFS-0480-BHD52D	PFS-0480-BHD52W	
—	200	625 A	PFS-0625-BHD54D	PFS-0625-BHD54W	
—	250	780 A	PFS-0780-BHD56D	PFS-0780-BHD56W	
230	0.37	0.5	5 A	PFS-0005-BAD33D	PFS-0005-BAD33W
	0.55	0.75	5 A	PFS-0005-BAD34D	PFS-0005-BAD34W
	0.75	1	5 A	PFS-0005-BAD35D	PFS-0005-BAD35W
	1.1	1.5	25 A	PFS-0025-BAD36D	PFS-0025-BAD36W
	1.5	2	25 A	PFS-0025-BAD37D	PFS-0025-BAD37W
	2.2	3	25 A	PFS-0025-BAD38D	PFS-0025-BAD38W
	3.7	5	25 A	PFS-0025-BAD39D	PFS-0025-BAD39W
	5.5	7.5	25 A	PFS-0025-BAD40D	PFS-0025-BAD40W
	7.5	10	43 A	PFS-0043-BAD41D	PFS-0043-BAD41W
	11	15	43 A	PFS-0043-BAD42D	PFS-0043-BAD42W
	15	20	60 A	PFS-0060-BAD43D	PFS-0060-BAD43W
	18.5	25	85 A	PFS-0085-BAD44D	PFS-0085-BAD44W
	22	30	85 A	PFS-0085-BAD45D	PFS-0085-BAD45W
	30	40	108 A	PFS-0108-BAD46D	PFS-0108-BAD46W
	37	50	135 A	PFS-0135-BAD47D	PFS-0135-BAD47W
	45	60	201 A	PFS-0201-BAD48D	PFS-0201-BAD48W
	55	75	201 A	PFS-0201-BAD49D	PFS-0201-BAD49W
	75	100	251 A	PFS-0251-BAD50D	PFS-0251-BAD50W
	90	125	317 A	PFS-0317-BAD51D	PFS-0317-BAD51W
	110	150	361 A	PFS-0361-BAD52D	PFS-0361-BAD52W
132	200	480 A	PFS-0480-BAD54D	PFS-0480-BAD54W	
185	250	625 A	PFS-0625-BAD56D	PFS-0625-BAD56W	
220	300	780 A	PFS-0780-BAD57D	PFS-0780-BAD57W	

Combination Circuit Breaker PF Softstarters include:

- A thermal magnetic circuit breaker with external operating handle
- A 120V control power transformer with fused primary and secondary
- PF built-in electronic motor overload protection
- PF built-in SCR bypass/run contactor
- Available in UL Type 12 or 4 Enclosures
- Terminal blocks for remote control devices

D
PFS Softstarters

① Other UL Type enclosures available. Contact your Sprecher + Schuh representative.
 ② See page D48 if ordering factory installed PFB Pump Control or PFD Smart Motor Bake Control Modules, or other options.
 ③ The nominal current rating for the combination package may differ from the controller, based on the horsepower. Consult your Sprecher + Schuh representative.
 ④ See page D57 for circuit breaker ratings.
 ⑤ For outdoor applications, replace "D" in catalog number with an "R". All enclosures are Type-12 with a Drip Shield. Example: PFS-0085-BHD43D becomes PFS-0085-BHD43R.

Enclosed Combination Circuit Breaker - Line Connected ①②④

Rated Voltage [V AC]	kW 50 Hz	Hp 60 Hz	Controller Current Rating ⑤	Type 12 [Type 3R ⑥] Industrial Dusttight Catalog Number	Type 4 Watertight Catalog Number
460 ⑤	0.37	0.5	5 A	PFS-0005-BBD33D	PFS-0005-BBD33W
	0.55	0.75	5 A	PFS-0005-BBD34D	PFS-0005-BBD34W
	0.75	1	5 A	PFS-0005-BBD35D	PFS-0005-BBD35W
	1.1	1.5	5 A	PFS-0005-BBD36D	PFS-0005-BBD36W
	1.5	2	5 A	PFS-0005-BBD37D	PFS-0005-BBD37W
	2.2	3	5 A	PFS-0005-BBD38D	PFS-0005-BBD38W
	3.7	5	25 A	PFS-0025-BBD39D	PFS-0025-BBD39W
	5.5	7.5	25 A	PFS-0025-BBD40D	PFS-0025-BBD40W
	7.5	10	25 A	PFS-0025-BBD41D	PFS-0025-BBD41W
	11	15	25 A	PFS-0025-BBD42D	PFS-0025-BBD42W
	15	20	43 A	PFS-0043-BBD43D	PFS-0043-BBD43W
	18.5	25	43 A	PFS-0043-BBD44D	PFS-0043-BBD44W
	22	30	43 A	PFS-0043-BBD45D	PFS-0043-BBD45W
	30	40	60 A	PFS-0060-BBD46D	PFS-0060-BBD46W
	37	50	85 A	PFS-0085-BBD47D	PFS-0085-BBD47W
	45	60	85 A	PFS-0085-BBD48D	PFS-0085-BBD48W
	55	75	108 A	PFS-0108-BBD49D	PFS-0108-BBD49W
	75	100	135 A	PFS-0135-BBD50D	PFS-0135-BBD50W
	90	125	201 A	PFS-0201-BBD51D	PFS-0201-BBD51W
	110	150	201 A	PFS-0201-BBD52D	PFS-0201-BBD52W
132	200	251 A	PFS-0251-BBD54D	PFS-0251-BBD54W	
160	250	317 A	PFS-0317-BBD56D	PFS-0317-BBD56W	
200	300	361 A	PFS-0361-BBD57D	PFS-0361-BBD57W	
250	350	480 A	PFS-0480-BBD58D	PFS-0480-BBD58W	
250	400	480 A	PFS-0480-BBD59D	PFS-0480-BBD59W	
355	500	625 A	PFS-0625-BBD61D	PFS-0625-BBD61W	
450	600	780 A	PFS-0780-BBD62D	PFS-0780-BBD62W	
575	0.37	0.75	5 A	PFS-0005-BCD34D	PFS-0005-BCD34W
	0.55	1	5 A	PFS-0005-BCD35D	PFS-0005-BCD35W
	0.75	1.5	5 A	PFS-0005-BCD36D	PFS-0005-BCD36W
	1.1	2	5 A	PFS-0005-BCD37D	PFS-0005-BCD37W
	2.2	3	5 A	PFS-0005-BCD38D	PFS-0005-BCD38W
	3.7	5	25 A	PFS-0025-BCD39D	PFS-0025-BCD39W
	5.5	7.5	25 A	PFS-0025-BCD40D	PFS-0025-BCD40W
	7.5	10	25 A	PFS-0025-BCD41D	PFS-0025-BCD41W
	11	15	25 A	PFS-0025-BCD42D	PFS-0025-BCD42W
	15	20	43 A	PFS-0043-BCD43D	PFS-0043-BCD43W
	18.5	25	43 A	PFS-0043-BCD44D	PFS-0043-BCD44W
	22	30	43 A	PFS-0043-BCD45D	PFS-0043-BCD45W
	22	40	43 A	PFS-0043-BCD46D	PFS-0043-BCD46W
	37	50	60 A	PFS-0060-BCD47D	PFS-0060-BCD47W
	45	60	85 A	PFS-0085-BCD48D	PFS-0085-BCD48W
	55	75	85 A	PFS-0085-BCD49D	PFS-0085-BCD49W
	75	100	108 A	PFS-0108-BCD50D	PFS-0108-BCD50W
	90	125	135 A	PFS-0135-BCD51D	PFS-0135-BCD51W
	110	150	201 A	PFS-0201-BCD52D	PFS-0201-BCD52W
	132	200	201 A	PFS-0201-BCD54D	PFS-0201-BCD54W
160	250	251 A	PFS-0251-BCD56D	PFS-0251-BCD56W	
200	300	317 A	PFS-0317-BCD57D	PFS-0317-BCD57W	
250	350	361 A	PFS-0361-BCD58D	PFS-0361-BCD58W	
295	400	480 A	PFS-0480-BCD59D	PFS-0480-BCD59W	
315	450	480 A	PFS-0480-BCD60D	PFS-0480-BCD60W	
315	500	480 A	PFS-0480-BCD61D	PFS-0480-BCD61W	
450	600	625 A	PFS-0625-BCD62D	PFS-0625-BCD62W	
560	800	780 A	PFS-0780-BCD65D	PFS-0780-BCD65W	

Combination Circuit Breaker PF Softstarters include:

- A thermal magnetic circuit breaker with external operating handle
- A 120V control power transformer with fused primary and secondary
- PF built-in electronic motor overload protection
- PF built-in SCR bypass/run contactor
- Available in UL Type 12 or 4 Enclosures
- Terminal blocks for remote control devices

- ① Other UL Type enclosures available. Contact your Sprecher + Schuh representative.
- ② See page D48 if ordering factory installed PFB Pump Control or PFD Smart Motor Bake Control Modules, or other options.
- ③ The nominal current rating for the combination package may differ from the controller, based on the horse power. Consult your Sprecher + Schuh representative.
- ④ See page D57 for circuit breaker ratings.
- ⑤ For 380V applications choose softstarter based on FLA, then change the BB code in the catalog number to BG. Example PFS-0085-BBD47D becomes PFS-0085-BGD47D, which covers 25 HP @ 380V FLA 37. Price remains the same.
- ⑥ For outdoor applications, replace "D" in catalog number with an "R". All enclosures are Type-12 with a Drip Shield. For example catalog number PFS-0085-BBD47D becomes PFS-0085-BBD47R.

D
PFS Softstarters

Enclosed Combination Fusible Starters - Line Connected ①②④

Rated Voltage [V AC]	kW 50 Hz	Hp 60 Hz	Controller Current Rating ③	Type 12 [Type 3R ⑤] Industrial Dusttight	Type 4 Watertight	
				Catalog Number	Catalog Number	
200	—	0.5	5 A	PFS-0005-FHD33D	PFS-0005-FHD33W	
	—	0.75	5 A	PFS-0005-FHD34D	PFS-0005-FHD34W	
	—	1	5 A	PFS-0005-FHD35D	PFS-0005-FHD35W	
	—	1.5	25 A	PFS-0025-FHD36D	PFS-0025-FHD36W	
	—	2	25 A	PFS-0025-FHD37D	PFS-0025-FHD37W	
	—	3	25 A	PFS-0025-FHD38D	PFS-0025-FHD38W	
	—	5	25 A	PFS-0025-FHD39D	PFS-0025-FHD39W	
	—	7.5	25 A	PFS-0025-FHD40D	PFS-0025-FHD40W	
	—	10	43 A	PFS-0043-FHD41D	PFS-0043-FHD41W	
	—	15	60 A	PFS-0060-FHD42D	PFS-0060-FHD42W	
	—	20	85 A	PFS-0085-FHD43D	PFS-0085-FHD43W	
	—	25	85 A	PFS-0085-FHD44D	PFS-0085-FHD44W	
	—	30	108 A	PFS-0108-FHD45D	PFS-0108-FHD45W	
	—	40	135 A	PFS-0135-FHD46D	PFS-0135-FHD46W	
	—	50	201 A	PFS-0201-FHD47D	PFS-0201-FHD47W	
	—	60	201 A	PFS-0201-FHD48D	PFS-0201-FHD48W	
	230	0.37	0.5	5 A	PFS-0005-FAD33D	PFS-0005-FAD33W
		0.55	0.75	5 A	PFS-0005-FAD34D	PFS-0005-FAD34W
0.75		1	5 A	PFS-0005-FAD35D	PFS-0005-FAD35W	
1.1		1.5	25 A	PFS-0025-FAD36D	PFS-0025-FAD36W	
1.5		2	25 A	PFS-0025-FAD37D	PFS-0025-FAD37W	
2.2		3	25 A	PFS-0025-FAD38D	PFS-0025-FAD38W	
3.7		5	25 A	PFS-0025-FAD39D	PFS-0025-FAD39W	
5.5		7.5	25 A	PFS-0025-FAD40D	PFS-0025-FAD40W	
7.5		10	43 A	PFS-0043-FAD41D	PFS-0043-FAD41W	
11		15	43 A	PFS-0043-FAD42D	PFS-0043-FAD42W	
15		20	60 A	PFS-0060-FAD43D	PFS-0060-FAD43W	
18.5		25	85 A	PFS-0085-FAD44D	PFS-0085-FAD44W	
22		30	85 A	PFS-0085-FAD45D	PFS-0085-FAD45W	
30		40	108 A	PFS-0108-FAD46D	PFS-0108-FAD46W	
37		50	135 A	PFS-0135-FAD47D	PFS-0135-FAD47W	
45		60	201 A	PFS-0201-FAD48D	PFS-0201-FAD48W	
55		75	201 A	PFS-0201-FAD49D	PFS-0201-FAD49W	
75		100	251 A	PFS-0251-FAD50D	PFS-0251-FAD50W	
90		125	317 A	PFS-0317-FAD51D	PFS-0317-FAD51W	
110		150	361 A	PFS-0361-FAD52D	PFS-0361-FAD52W	
132	200	480 A	PFS-0480-FAD54D	PFS-0480-FAD54W		
185	250	625 A	PFS-0625-FAD56D	PFS-0625-FAD56W		
220	300	780 A	PFS-0780-FAD57D	PFS-0780-FAD57W		

Combination Fusible PF Softstarters include:

- A fused switch with external operating handle
- A 120V control power transformer with fused primary and secondary
- PF built-in electronic motor overload protection
- PF built-in SCR bypass/run contactor
- Available in UL Type 12 or 4 Enclosures
- Terminal blocks for remote control devices

D
PFS Softstarters

- ① Other UL Type enclosures available. Contact your Sprecher + Schuh representative.
- ② See page D48 if ordering factory installed PFB Pump Control or PFD Smart Motor Bake Control Modules, or other options.
- ③ The nominal current rating for the combination package may differ from the controller, based on the horse power. Consult your Sprecher + Schuh representative.
- ④ Fuse clips accept J-type fuses. Power fuses are not supplied. See page D57 for Fusible Disconnect amp ratings.
- ⑤ For outdoor applications, replace "D" in catalog number with an "R". All enclosures are Type-12 with a Drip Shield. For example: PFS-0085-FHD43D becomes PFS-0085-FHD43R.

Enclosed Combination Fusible Starters - Line Connected ①②④

Rated Voltage [V AC]	kW 50 Hz	Hp 60 Hz	Controller Current Rating ⑤	Type 12 [Type 3R ⑥] Industrial Dusttight	Type 4 Watertight
				Catalog Number	Catalog Number
460 ⑥	0.37	0.5	5 A	PFS-0005-FBD33D	PFS-0005-FBD33W
	0.55	0.75	5 A	PFS-0005-FBD34D	PFS-0005-FBD34W
	0.75	1	5 A	PFS-0005-FBD35D	PFS-0005-FBD35W
	1.1	1.5	5 A	PFS-0005-FBD36D	PFS-0005-FBD36W
	1.5	2	5 A	PFS-0005-FBD37D	PFS-0005-FBD37W
	2.2	3	5 A	PFS-0005-FBD38D	PFS-0005-FBD38W
	3.7	5	25 A	PFS-0025-FBD39D	PFS-0025-FBD39W
	5.5	7.5	25 A	PFS-0025-FBD40D	PFS-0025-FBD40W
	7.5	10	25 A	PFS-0025-FBD41D	PFS-0025-FBD41W
	11	15	25 A	PFS-0025-FBD42D	PFS-0025-FBD42W
	15	20	43 A	PFS-0043-FBD43D	PFS-0043-FBD43W
	18.5	25	43 A	PFS-0043-FBD44D	PFS-0043-FBD44W
	22	30	43 A	PFS-0043-FBD45D	PFS-0043-FBD45W
	30	40	60 A	PFS-0060-FBD46D	PFS-0060-FBD46W
	37	50	85 A	PFS-0085-FBD47D	PFS-0085-FBD47W
	45	60	85 A	PFS-0085-FBD48D	PFS-0085-FBD48W
	55	75	108 A	PFS-0108-FBD49D	PFS-0108-FBD49W
	75	100	135 A	PFS-0135-FBD50D	PFS-0135-FBD50W
	90	125	201 A	PFS-0201-FBD51D	PFS-0201-FBD51W
	110	150	201 A	PFS-0201-FBD52D	PFS-0201-FBD52W
132	200	251 A	PFS-0251-FBD54D	PFS-0251-FBD54W	
160	250	317 A	PFS-0317-FBD56D	PFS-0317-FBD56W	
200	300	361 A	PFS-0361-FBD57D	PFS-0361-FBD57W	
250	350	480 A	PFS-0480-FBD58D	PFS-0480-FBD58W	
250	400	480 A	PFS-0480-FBD59D	PFS-0480-FBD59W	
355	500	625 A	PFS-0625-FBD61D	PFS-0625-FBD61W	
450	600	780 A	PFS-0780-FBD62D	PFS-0780-FBD62W	
575	0.37	0.75	5 A	PFS-0005-FCD34D	PFS-0005-FCD34W
	0.55	1	5 A	PFS-0005-FCD35D	PFS-0005-FCD35W
	0.75	1.5	5 A	PFS-0005-FCD36D	PFS-0005-FCD36W
	1.1	2	5 A	PFS-0005-FCD37D	PFS-0005-FCD37W
	2.2	3	5 A	PFS-0005-FCD38D	PFS-0005-FCD38W
	3.7	5	25 A	PFS-0025-FCD39D	PFS-0025-FCD39W
	5.5	7.5	25 A	PFS-0025-FCD40D	PFS-0025-FCD40W
	7.5	10	25 A	PFS-0025-FCD41D	PFS-0025-FCD41W
	11	15	25 A	PFS-0025-FCD42D	PFS-0025-FCD42W
	15	20	43 A	PFS-0043-FCD43D	PFS-0043-FCD43W
	18.5	25	43 A	PFS-0043-FCD44D	PFS-0043-FCD44W
	22	30	43 A	PFS-0043-FCD45D	PFS-0043-FCD45W
	22	40	43 A	PFS-0043-FCD46D	PFS-0043-FCD46W
	37	50	60 A	PFS-0060-FCD47D	PFS-0060-FCD47W
	45	60	85 A	PFS-0085-FCD48D	PFS-0085-FCD48W
	55	75	85 A	PFS-0085-FCD49D	PFS-0085-FCD49W
	75	100	108 A	PFS-0108-FCD50D	PFS-0108-FCD50W
	90	125	135 A	PFS-0135-FCD51D	PFS-0135-FCD51W
	110	150	201 A	PFS-0201-FCD52D	PFS-0201-FCD52W
	132	200	201 A	PFS-0201-FCD54D	PFS-0201-FCD54W
160	250	251 A	PFS-0251-FCD56D	PFS-0251-FCD56W	
200	300	317 A	PFS-0317-FCD57D	PFS-0317-FCD57W	
250	350	361 A	PFS-0361-FCD58D	PFS-0361-FCD58W	
295	400	480 A	PFS-0480-FCD59D	PFS-0480-FCD59W	
315	450	480 A	PFS-0480-FCD60D	PFS-0480-FCD60W	
315	500	480 A	PFS-0480-FCD61D	PFS-0480-FCD61W	
450	600	625 A	PFS-0625-FCD62D	PFS-0625-FCD62W	
560	800	780 A	PFS-0780-FCD65D	PFS-0780-FCD65W	

Combination Fusible PF Softstarters include:

- A fused switch with external operating handle
- A 120V control power transformer with fused primary and secondary
- PF built-in electronic motor overload protection
- PF built-in SCR bypass/run contactor
- Available in UL Type 12 or 4 Enclosures
- Terminal blocks for remote control devices

- ① Other UL Type enclosures available. Contact your Sprecher + Schuh representative for pricing.
- ② See page D48 if ordering factory installed PFB Pump Control or PFD Smart Motor Bake Control Modules, or other options.
- ③ The nominal current rating for the combination package may differ from the controller, based on the horsepower. Consult your Sprecher + Schuh representative.
- ④ Fuse clips accept J-type fuses (Class L fuses for some PF-480 applications; see page D57 for details). Power fuses are not supplied.
- ⑤ For 380V applications choose softstarter based on FLA, then change the FB code in the catalog number to FG. Example PFS-0085-FBD47D becomes PFS-0085-FGD47D, which covers 25 HP @ 380V FLA 37.
- ⑥ For outdoor applications, replace "D" in catalog number with an "R". All enclosures are Type-12 with a Drip Shield. Example: PFS-0085-FBD47D becomes PFS-0085-FBD47R.

D
PFS Softstarters

Options - Factory Modifications

D
PFS Softstarters

Description	Catalog Number
<p>Pump Control ① Provides smooth motor acceleration and deceleration, reducing surges caused by the starting and stopping of centrifugal pumps. Starting time is adjustable from 0...30 seconds and stopping time is adjustable from 0...120 seconds</p> <p>For 5A unit For 25A unit For 43A unit For 60A unit For 85A unit For 108A unit For 135A unit For 201A unit For 251A unit For 317A unit For 361A unit For 480A unit For 625A unit For 780A unit For 970A unit For 1250A unit</p>	Change "PFS" to "PFB"
<p>Braking Control ①② Provides Smart Motor Brake, Accu-Stop, and Slow Speed with Braking</p> <p>For 5A unit For 25A unit For 43A unit For 60A unit For 85A unit For 108A unit For 135A unit For 201A unit For 251A unit For 317A unit For 361A unit For 480A unit For 625A unit For 780A unit For 970A unit For 1250A unit</p>	Change "PFS" to "PFD"
<p>Protective Module Protects power components from transient voltage spikes and transient voltage spikes and shunts noise energy</p> <p>600V Line Side Protective Module 600V Load Side Protective Module 600V Both Line and Load Side Protective Modules</p>	<p>Add suffix - "-8L" Add suffix - "-8M" Add suffix - "-8B"</p>

Description	Catalog Number
<p>Pushbuttons (2) START and STOP pushbuttons for enclosed softstarters</p>	Add suffix " -3 "
<p>Selector Switch Two or three position selector switch for enclosed softstarters "ON-OFF" "HAND-OFF-AUTO"</p>	<p>Add suffix "-6" Add suffix "-7"</p>
<p>Pilot Light ③ Red pilot light with "RUN" inscription for enclosed softstarters</p>	Add suffix " -1 "
<p>Voltmeter (Panelboard) Measures all three phases. Includes switch.</p>	Add suffix " -VM3 "
<p>Ammeter (Panelboard) For monitoring all three phases. Includes switch.</p>	Add suffix " -AM3 "
<p>Elapsed Time Meter Measures elapsed motor running time</p>	Add suffix " -ETM "

- ① Only one option may be added to the standard unit. See detailed descriptions of options starting on page D34.
- ② Not intended to be used as an emergency stop. Refer to applicable standards for emergency stop requirements.
- ③ When adding Pilot Lights plus other cover controls, add the Pilot Light first. For example; to add a Start-Stop Pushbutton and a Pilot Light, add **-13** at the end of the part number, not -31.

Options - Field Modifications

Protective Modules ❶

 <p>PFP-0085-600V</p>	Current Rating	Description	Catalog Number
	5...85	600V Protective Module <ul style="list-style-type: none"> • PF (3 Lead) Line Connected Applications: Protective modules may be installed on the line and/or load side • PF (6 Lead) Delta Connected Applications: Protective modules must be installed on the line side only. • Clamping voltage range 705V...1750V, energy rating 290 joules 	PFP-0085-600V
108...480	PFP-0480-600V		

Terminal Lug Kits (108...1250 A) ❷

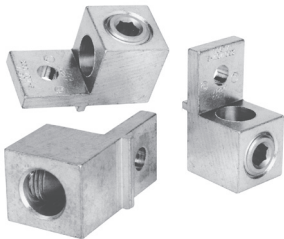
	Current Rating (A)	Conductor Size	Total No. of Line Controller Terminal Lugs Possible Each Side		Pkg. Qty.	Catalog Number
			Line Side	Load Side		
	108...135	#6...250 MCM AWG	3	3	3	PNX-1120
	201...251	16 mm ² ...120mm ²	6	6		PNX-1240
	317...480	#4...500 MCM AWG 25 mm ² ...240MM ²	6	6		CA6-L630
	625...780	2/0...500 MCM AWG	6	6		CA6-L860
	970	4/0...500 MCM AWG	3	3		CA6-L630
	1250	2/0...500 MCM AWG	3	3		CA6-L630
4/0...500 MCM AWG		3	3	CA6-L860		

IEC Terminal Covers ❸ ❹

	Description	Pkg. Qty.	Catalog Number
	IEC line or load terminal covers for 108...135A devices. Dead front protection	1	PFT-0135
	IEC line or load terminal covers for 201...251A devices. Dead front protection		PFT-0251
IEC line or load terminal covers for 317...480A devices. Dead front protection.	PFT-0480		

- ❶ The same protective module mounts on the line or load side of the PF Softstarter. For applications requiring both line and load side protection, two protective modules must be ordered.
- ❷ Line and Load terminals are provided as standard on enclosed PF Softstarters.
- ❸ PF 5...85A units have box lugs as standard. No additional lugs are required. The 1250 A device requires (1) CA6-L630 and (1) CA6-L860 per connection. When a multi-conductor lug is required, refer to the PF User Manual for appropriate lug catalog number.
- ❹ PFx-108...480 units include one terminal guard as standard.

Control Modules

Description	PF Rating	For units rated 200...600V AC			
		100...240V AC Catalog Number	Qty	24V AC/DC Catalog Number	Qty
Standard	All	PFS	1	PFS-024	1
Pump	All	PFB	1	PFB-024	1
Braking	5...85 A	PFD-0085	1	PFD-0085-024	1
	108...251 A	PFD-0251	1	PFD-0251-024	1
	317...480 A	PFD-0480	1	PFD-0480-024	1
	625...780 A	PFD-0780	1	~	~
	970...1250 A	PFD-1250	1	~	~

Power Poles

PF Rating	Series	Line Voltage 200...600V Catalog Number ①	Qty
5 A	B	PFL-0005-600V ②	1
25 A	B	PFL-0025-600V ②	1
43 A	B	PFL-0043-600V ②	1
60 A	B	PFL-0060-600V ②	1
85 A	B	PFL-0085-600V ②	1
108 A	B	PFL-0108-600V ②	1
135 A	B	PFL-0135-600V ②	1
201 A	B	PFL-0201-600V ②	1
251 A	B	PFL-0251-600V ②	1
317 A	B	PFL-0317-600V ②	1
361 A	B	PFL-0361-600V ②	1
480 A	B	PFL-0480-600V ②	1
625 A	B	PFL-0625-600V ②	1
780 A	B	PFL-0780-600V ②	1
970 A	B	PFL-0970-600V ②	1
1250 A	B	PFL-1250-600V ②	1

Each power pole contains two SCR's and one bypass contactor power pole. The PF requires three power poles. For example: the replacement power pole for a PFS-0108-600V series B is PFL-0108-600V

Internal Heatsink Fans

PF Rating	Series	Catalog Number	Qty
5...85 A	B	PFV-0085	1
108...135 A	B		
201...251 A	B	PFV-0251	1
317...480 A	B	PFV-0480	1
625...1250 A	B	PFV-1250-120	1
625...1250 A	B	PFV-1250-230	1

By-Pass Contactor ④

PF Rating	Series	110/120V AC Catalog Number		Qty	230/240V AC Catalog Number		Qty
625...780 A	B	CA6-180-EI-11-120	See page A122	1	CA6-180-EI-11-220W	See page A122	1
970...1250 A	B	CA6-420-EI-11-120		1	CA6-420-EI-11-220W		1

- ① One piece provided per part number.
- ② Part number contains three power poles.
- ③ Part number contains one power pole.
- ④ See special installation instructions included in package.

Standard Features

Installation	Power Wiring	Standard squirrel-cage induction motor or a Wye-Delta, six-lead motor.
	Control Wiring	2- and 3-wire control for a wide variety of applications.
Setup	Keypad	Front keypad and backlit LCD display.
Starting and Stopping Modes		<ul style="list-style-type: none"> • Soft Start • Current Limit Start • Dual Ramp • Full Voltage • Linear Speed Acceleration • Preset Slow Speed • Soft Stop
Protection and Diagnostics		Power loss, line fault, voltage unbalance, excessive start/hour, phase reversal, undervoltage, overvoltage, controller temp, stall, jam, open gate, overload, underload.
Metering		Amps, Volts, kW, kWh, elapsed time, power factor, motor thermal capacity usage.
Alarm Contact		Overload, underload, undervoltage, overvoltage, unbalance, jam, stall, and ground fault
Status Indication		Stopped, starting, stopping, at speed, alarm, and fault.
Auxiliary Contacts		Four fully programmable contacts as normal/up-to-speed/external bypass/fault/alarm, (N.O./N.C.). On external bypass (N.O. only).

Optional Features

Pump Control		Helps reduce fluid surges in centrifugal pumping systems during starting and stopping period. Starting time is adjustable from 0...30 seconds. Stopping time is adjustable from 0...120 seconds.
Braking Control	Smart Motor Brake	Provides motor braking without additional equipment for applications that require the motor to stop quickly. Braking current is adjustable from 0...400% of the motor's full load current rating.
	Accu-Stop	Provides controlled position stopping. During stopping, braking torque is applied to the motor until it reaches preset slow speed (7% or 15% of rated speed) and holds the motor at this speed until a stop command is given. Braking torque is then applied until the motor reaches zero speed. Braking current is programmable from 0...450% of full load current.
	Slow Speed with Braking	Used on applications that require slow speed (in the forward direction) for positioning or alignment and also require braking control to stop.

Technical Information

Electrical Ratings		UL/CSA/NEMA		IEC	
Power Circuit	Rated Operation Voltage	200...600V AC (-15%, +10%)		200...500V	
	Rated Insulation Voltage	N/A		500V	
	Rated Impulse Voltage	N/A		6000V	
	Dielectric Withstand	2200V AC		2500V	
	Repetitive Peak Inverse Voltage Rating	1600V		1600V	
	Operating Frequency	50/60 Hz			
	Utilization Category	5...480 A	MG 1		AC-53B:3.0-50:1750
		625...1250 A	MG 1		AC-53B:3.0-50:3550
	Protection Against Electrical Shock	5...85 A	NA		IP20
		108...480 A			IP2X (with terminal covers)
625...1250 A		IP00 (open device)			
DV/DT Protection	RC Snubber Network				
Transient Protection	Metal Oxide Varistors: 220 Joules				
Control Circuit	Rated Operational Voltage	UL/CSA/NEMA		IEC	
		100...240V AC or 24V AC/DC (-15%, +10%)			
		110/120V AC and 230/240V AC			
	Rated Insulation Voltage	N/A		240V	
	Rated Impulse Voltage	N/A		3000V	
	Dielectric Withstand	1600V AC		2000V	
	Operating Frequency	50/60 Hz			
	Input on state voltage minimum (terminals 15-18)	85V AC, 19.2V DC / 20.4V AC			
	Input on state current (terminals 15-18)	20 mA @ 120V AC/40 mA @ 240V AC, 7.6 mA @ 24V AC/DC			
	Input off state voltage maximum (terminals 15-18)	50V AC, 10V DC / 12V AC			
Input off state current @ input off state voltage (terminals 15-18)	<10 mA AC, <3 mA DC				

Electrical Ratings

SCPD Performance 200...600V		Type 1 ④					
SCPD List ①	Device Rating	Max. Standard Available Fault	Max. Standard Fuse (A) ②	Max. Standard Available Fault	Max. Circuit Breaker (A)	Max. High Fault	Max. Fuse (A) ③
Line Device Operational Current Rating (A)	5	5 kA	20	5 kA	20	70 kA	10
	25	5 kA	100	5 kA	100	70 kA	50
	43	10 kA	150	10 kA	150	70 kA	90
	60	10 kA	225	10 kA	225	70 kA	125
	85	10 kA	300	10 kA	300	70 kA	175
	108	10 kA	400	10 kA	300	70 kA	200
	135	10 kA	500	10 kA	400	70 kA	225
	201	18 kA	600	18 kA	600	70 kA	350
	251	18 kA	700	18 kA	700	70 kA	400
	317	30 kA	800	30 kA	800	69 kA	500
	361	30 kA	1000	30 kA	1000	69 kA	600
	480	42 kA	1200	42 kA	1200	69 kA	800
	625	42 kA	1600	42 kA	1600	74 kA	1600
	780	42 kA	1600	42 kA	2000	74 kA	1600
	970	85 kA	2500	85 kA	2500	85 kA	2500
	1250	85 kA	3000	85 kA	3200	85 kA	3000
	Delta Device Operational Current Rating (A)	8.7	5 kA	35	5 kA	35	70 kA
43		5 kA	150	5 kA	150	70 kA	90
74		10 kA	300	10 kA	300	70 kA	150
104		10 kA	400	10 kA	400	70 kA	200
147		10 kA	400	10 kA	400	70 kA	200
187		10 kA	600	10 kA	500	70 kA	300
234		10 kA	700	10 kA	700	70 kA	400
348		18 kA	1000	18 kA	1000	70 kA	600
435		18 kA	1200	18 kA	1200	70 kA	800
549		30 kA	1600	30 kA	1600	69 kA	1000
625		30 kA	1600	30 kA	1600	69 kA	1200
831		42 kA	1600	30 kA	1600	69 kA	1600
850		42 kA	1600	42 kA	2000	74 kA	1600
900		42 kA	1600	42 kA	2000	74 kA	1600
1200		85 kA	3000	85 kA	3200	85 kA	3000
1600		85 kA	3000	85 kA	3200	85 kA	3000
Semi-Conductor Fusing		Device Rating	Max. Standard Available Fault	Max. Ampere tested - North American Style	Max. Ampere Tested - European Style		
SCCR ④	Maximum FLC	108	70 kA	A070URD33xxx500	6.9 gRB 73xxx400 6.6URD33xxx500		
		135	70 kA	A070URD33xxx500	6.9 gRB 73xxx400 6.6URD33xxx500		
		201	70 kA	A070URD33xxx700	6.9 gRB 73xxx630 6.6URD33xxx700		
		251	70 kA	A070URD33xxx700	6.9 gRB 73xxx630 6.6URD33xxx700		
		317	70 kA	A070URD33xxx900	6.9 gRB 73xxx800 6.6URD33xxx900		
		361	70 kA	A070URD33xxx900	6.9 gRB 73xxx800 6.6URD33xxx900		
		480	70 kA	A070URD33xxx1250 A100URD73xxx1250	9 URD 73xxx1250 6.6URD33xxx1250		
		625	70 kA	A070URD33xxx1400	6.6URD33xxx1400		
		780	70 kA	A070URD33xxx1400	6.6URD33xxx1400		
		970	85 kA	Two fuses in parallel A070URD33xxx1250	Two fuses in parallel 6.6URD33xxx1250		
		1250	85 kA	Two fuses in parallel A070URD33xxx1250	Two fuses in parallel 6.6URD33xxx1250		

① Consult local codes for proper sizing of short circuit protection.
 ② Non-time delay fuses (K5 – 5 ...480V (8.7...831 A) devices; Class L – 625...1250V (850...1600 A) devices).
 ③ High capacity fault rating when used with time delay class CC, J, or L fuses.

④ Type 1 performance/protection indicates that, under a short-circuit condition, the fused or circuit breaker-protected starter shall cause no danger to persons or installation but may not be suitable for further service without repair or replacement.

Electrical Ratings		120..240V AC	Transformer	75 VA	
Power Requirements	Control Module	24V AC	Transformer	130 VA	
		24V DC	Inrush Current	5 A	
	Inrush Time		250 ms		
	Transient Watts		60 W		
	Transient Time		500 ms		
	Steady State Watts		24 W		
	Minimum Power Supply		FLEX6024A		
		625...1250 A	751 VA (recommended 800 VA)		
	Heatsink Fan(s) (A) ❶		5...135 A, 20 VA		
			201...251 A, 40 VA		
		317...480 A, 60 VA			
		625...1250 A, 150 VA			
Steady State Heat Dissipation with Control and Fan Power (Watts)	Controller Rating (A)	5	70		
		23	70		
		43	81		
		60	97		
		85	129		
		108	91		
		135	104		
		201	180		
		251	198		
		317	225		
		361	245		
		480	290		
		625	446		
		780	590		
970	812				
1250	1222				
Auxiliary Contacts 19/20 (Aux #1) 29/30 (Aux #2) 31/32 (Aux #3) 33/34 (Aux #4)	Type of Control Circuit	Electromagnetic relay			
	Number of Contacts	1			
	Type of Contacts	programmable N.O./N.C.			
	Type of Current	AC			
	Rated Optional Current	3 A @ 120V AC, 1.5 A @ 240V AC			
	Conventional Thermal Current I_{th}	5 A			
	Make/Break VA	3600/360			
	Utilization Category	AC-15			
PTC Input Ratings	Response Resistance	3400 Ω \pm 150 Ω			
	Reset Resistance	1600 Ω \pm 100 Ω			
	Short-Circuit Trip Resistance	25 Ω \pm 10 Ω			
	Max. Voltage at PTC Terminals ($R_{PTC} = 4k$)	< 7.5V			
	Max. Voltage at PTC Terminals ($R_{PTC} = open$)	30V			
	Max. No. of Sensors	6			
	Max. Cold Resistance of PTC Sensor Chain	1500 Ω			
Tach input	Response Time	800 ms			
		0...5V DC, 4.5V DC = 100% Speed			

Environmental	
Operating Temperature Range	-5...50 °C (23...122 °F) (open) -5...40 °C (23...104 °F) (enclosed)
Storage and Transportation Temperature Range	-20...+75 °C (-4...167 °F)
Altitude	2000 m (6560 ft)
Humidity	5...95% (non-condensing)
Pollution Degree	2

❶ For devices rated 5...480 A, heatsink fans can be powered by either 110/120V AC or 220/240V AC.
For devices rated 625...1250 A, heatsink fans can only be powered by 110/120V AC.

Mechanical				
Resistance to Vibration	Operational	All	1.0 G Peak, 0.15 mm (0.006 in.) displacement	
	Non-Operational	5...480 A 625...1250 A	2.5 G Peak, 0.38 mm (0.015 in.) displacement 1.0 G Peak, 0.15 mm (0.006 in.) displacement	
Resistance to Shock	Operational	5...85 A	15 G	
		108...480 A	5.5 G	
		625...1250 A	4 G	
	Non-Operational	5...85 A	30 G	
		108...480 A	25 G	
		625...1250 A	12 G	
Construction	Power Poles	5...85 A	Heatsink thyristor modular design	
	Power Poles	108...1250 A	Heatsink hockey puck thyristor modular design	
	Control Modules		Thermoset and Thermoplastic Moldings	
	Metal Parts		Plated Brass, Copper or Painted Steel	
Terminals	Power Terminals	5...85 A	Cable size – Line Upper – 2.5...95 mm ² (14...3/0 AWG) Line Lower – 0.8...2.5 mm ² (18...14 AWG) Load Upper – 2.5...50 mm ² (14...1 AWG) Load Lower – 0.8...2.5 mm ² (18...14 AWG) Tightening torque – 14.7 N•m (130 lb.-in.) Wire strip length – 18...20 mm (0.22...0.34 in.)	
		108...135 A	One M10 x 1.5 diameter hole per power pole	
		201...251 A	Two M10 x 1.5 diameter holes per power pole	
		317...480 A	Two M12 x 1.75 diameter holes per power pole	
	625...1250 A	Two 13.5 mm (0.53 in.) diameter holes per power pole		
	Power Terminal Markings		NEMA, CENELEC EN50 012	
	Control Terminals	M3 screw clamp	Clamping yoke connection	
Other				
EMC Emission Levels	Conducted Radio Frequency Emissions Radiated emissions		Class A Class A	
EMC Immunity Levels	Electrostatic Discharge Radio Frequency Electromagnetic Field Fast Transient Surge Transient		B kV Air Discharge Per EN/IEC 60947-4-2 Per EN/IEC 60947-4-2 Per EN/IEC 60947-4-2	
Overload Characteristics	Current Range		Line	Delta
		5	1...5	1.7...9
		25	5...25	8.6...43
		43	8.6...43	14.8...75
		60	12...60	20.8...104
		85	17...85	29.4...147
		108	27...108	47...187
		135	34...135	59...234
		201	67...201	116...348
		251	84...251	145...435
		317	106...317	183...549
		361	120...361	208...625
		480	160...480	277...831
		625	208...625	283...850
		780	260...780	300...900
		970	323...970	400...1200
1250	416...1250	533...1600		
	Trip Classes		10, 15, 20, and 30	
	Trip Current Rating		117% of Motor FLC	
	Number of Poles		3	
Certifications	Open Type Controllers		CE Marked Per Low Voltage Directive 73/23/EEC, 93/68/EEC UL Listed (File No. E195687)	

Soft Stop, Pump Control and Braking Wiring Diagram

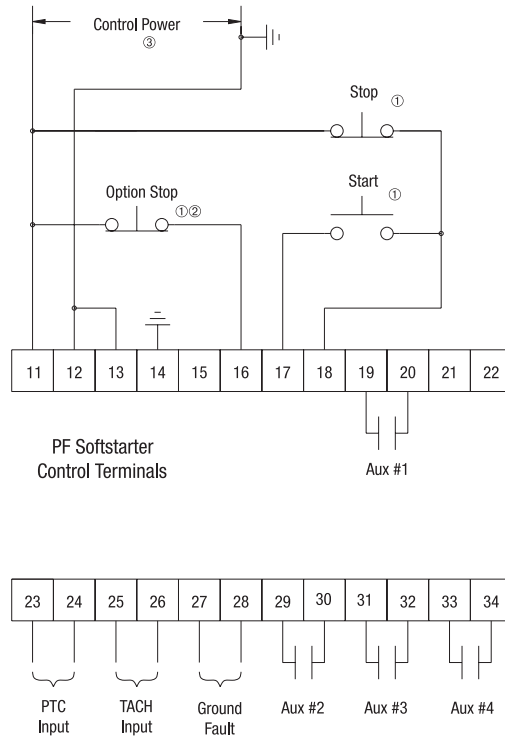

3-Wire Control

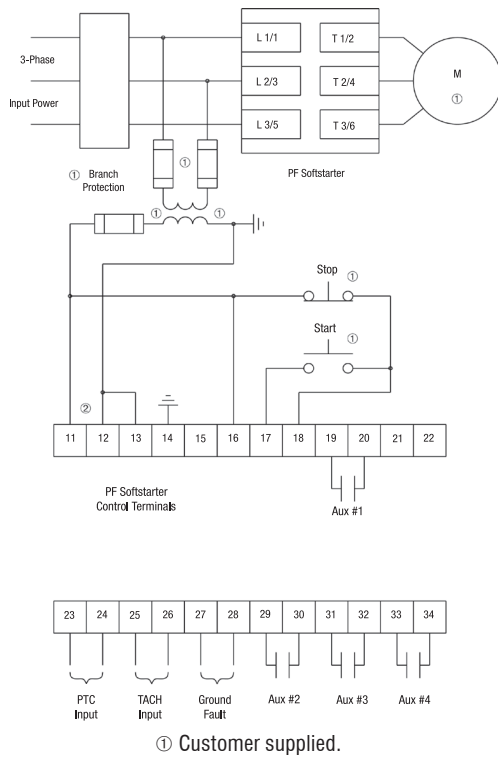

2-Wire Control

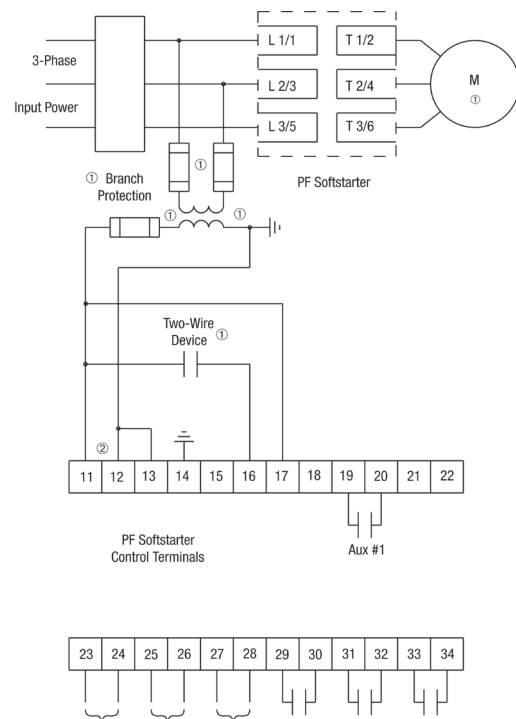

D
PFS Softstarters

Approximate Dimensions and Shipping Weights

Open Type Controllers

Dimensions are in millimeters (inches). Dimensions not intended for manufacturing purposes.

Rating (A)	Height	Width	Depth	Weight
5...85	321 (12.6)	150 (5.9)	203 (8.0)	5.7 kg (12.6 lbs)
108...135	443.7 (17.47)	196.4 (7.74)	205.2 (8.08)	15.0 kg (33 lbs)
201...251	560 (22.05)	225 (8.86)	253.8 (9.99)	304 kg (67 lbs)
317...480	600 (23.62)	290 (11.42)	276.5 (10.89)	45.8 kg (101 lbs)
625...780	1041.1 (41.0)	596.9 (23.5)	346.2 (13.63)	179 kg (395 lbs)
970...1250	1041.1 (41.0)	596.9 (23.5)	346.2 (13.63)	224 kg (495 lbs)

D
PFS Softstarters

Enclosed Type Line-Connected Controllers

IMPORTANT NOTE:

Factory-installed options may affect enclosure size requirements.
Exact dimensions can be obtained after order entry.
Please consult your local Sprecher + Schuh representative.

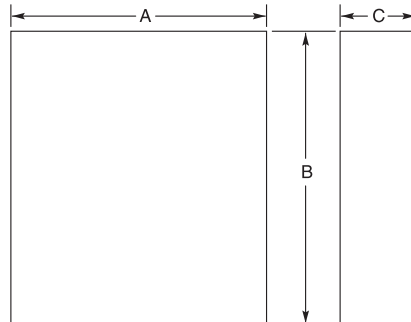

Controller Rating (A)	Disconnect Rating (A)	IP65 (Type 4/12)		
		Height B	Width A	Depth C
Non-Combination Controller				
5	—	610 (24)	508 (20)	254 (10)
25	—	610 (24)	508 (20)	254 (10)
43	—	610 (24)	508 (20)	254 (10)
60	—	610 (24)	508 (20)	254 (10)
85	—	610 (24)	508 (20)	254 (10)
108	—	762 (30)	610 (24)	305 (12)
135	—	762 (30)	610 (24)	305 (12)
201	—	914 (36)	762 (30)	406 (16)
251	—	914 (36)	762 (30)	406 (16)
317	—	1524 (60)	914 (36)	406 (16)
361	—	1524 (60)	914 (36)	406 (16)
480	—	1524 (60)	914 (36)	406 (16)
625	—	2286 (90)	1829 (72)	508 (20)
780	—	2286 (90)	1829 (72)	508 (20)
970 ①	—	2286 (90)	1829 (72)	508 (20)
1250 ①	—	2286 (90)	1829 (72)	508 (20)

① 970...1250 rated devices are only available as Type 1 and require a door-mounted fan, capable of delivering 204 cfm.

Approximate Dimensions ④

Enclosed Type Line-Connected Combination Controllers

IMPORTANT NOTE:

Factory-installed options may affect enclosure size requirements.
Exact dimensions can be obtained after order entry.
Please consult your local Sprecher + Schuh representative.

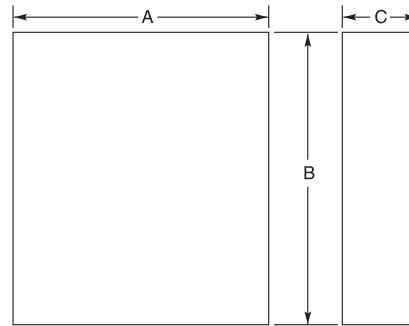

Controller Rating (A)	Disconnect Rating (A)	IP65 (Type 4/12)		
		Height B	Width A	Depth C
Combination Controllers with Fusible Disconnect				
5	30 A/J	610 (24)	508 (20)	254 (10)
25	30 A/J	610 (24)	508 (20)	254 (10)
43	60 A/J	610 (24)	508 (20)	254 (10)
60	100 A/J	610 (24)	508 (20)	254 (10)
85	100 A/J	610 (24)	508 (20)	254 (10)
108	200 A/J	914 (36)	762 (30)	406 (16)
135	200 A/J	914 (36)	762 (30)	406 (16)
201	400 A/J	1219 (48)	914 (36)	406 (16)
251	400 A/J	1219 (48)	914 (36)	406 (16)
317	600 A/J	1524 (60)	914 (36)	406 (16)
361 ①	600 A/J	1524 (60)	914 (36)	406 (16)
480 ②	600 A/J	1524 (60)	914 (36)	406 (16)
	800 A/L	2286 (90)	508 (20)	508 (20)
625	—	2286 (90)	1829 (72)	508 (20)
780	—	2286 (90)	1829 (72)	508 (20)
970 ③	—	2286 (90)	1829 (72)	508 (20)
1250 ③	—	2286 (90)	1829 (72)	508 (20)
Combination Controllers with Circuit Breaker				
5	15 A	610 (24)	508 (20)	254 (10)
25	30 A	610 (24)	508 (20)	254 (10)
43	80 A	610 (24)	508 (20)	254 (10)
60	100 A	610 (24)	508 (20)	254 (10)
85	125 A	610 (24)	508 (20)	254 (10)
108	175 A/175 A Plug	914 (36)	762 (30)	406 (16)
135	225 A/225 A Plug	914 (36)	762 (30)	406 (16)
201	300 A/300 A Plug	1219 (48)	914 (36)	406 (16)
251	400 A/400 A Plug	1219 (48)	914 (36)	406 (16)
317	600 A/500 A Plug	1524 (60)	914 (36)	406 (16)
361	600 A/600 A Plug	1524 (60)	914 (36)	406 (16)
480	800 A/800 A Plug	1524 (60)	914 (36)	406 (16)
625	—	2286 (90)	1829 (72)	508 (20)
780	—	2286 (90)	1829 (72)	508 (20)
970 ②	—	2286 (90)	1829 (72)	508 (20)
1250 ③	—	2286 (90)	1829 (72)	508 (20)

- ① Use this row for 460V -58 and 575V -59.
- ② Use this row for 460V -59 and 575 -60 and -61.
- ③ 970...1250 rated devices are only available as Type 1 and require a door-mounted fan, capable of delivering 240 cfm.
- ④ These dimensions are to be considered the recommended minimal enclosure dimensions and do not represent actual Sprecher + Schuh assembled product dimensions. Consult your local Sprecher + Schuh representative for details.

D
PFS Softstarters