

KT7 Assembly – Application Rating Chart (Ratings are dependent on type of application) ①

Rating Index	Assembly Components		Manual Controller or Group Installation				Combination Motor Controller (Type F)				Self-Protected Combination Motor Controller (Type E)	
			480V		600V		480Y / 277V		600Y / 347V		480Y / 277V	600Y / 347V
	KT7	Minimum Contactor Size	Type 1 KAIC	Type 2 KAIC	Type 1 KAIC	Type 2 KAIC	Type 1 KAIC	Type 2 KAIC	Type 1 KAIC	Type 2 KAIC	Type E KAIC	Type E KAIC
KT7 + CA7 UL Assemblies (CL7 / CLU7/ CK7 / CKU7)												
1	KTA7-25S-0.16A	CA7-9	65	65	47	47	65	65	47	47	65	47
2	KTA7-25S-0.25A	CA7-9	65	65	47	47	65	65	47	47	65	47
3	KTA7-25S-0.4A	CA7-9	65	65	47	47	65	65	47	47	65	47
4	KTA7-25S-0.63A	CA7-9	65	65	47	47	65	65	47	47	65	47
5	KTA7-25S-1A	CA7-9	65	65	47	47	65	65	47	47	65	47
6	KTA7-25S-1.6A	CA7-9	65	65	47	47	65	65	47	47	65	47
7	KTA7-25S-2.5A	CA7-9	65	65	30	10	65	65	30	10	65	~
8	KTA7-25S-4A	CA7-9	65	50	30	~	65	~	30	~	~	~
--	KTA7-25S-4A	CA7-30	65	~	30	~	65	~	30	~	~	~
9	KTA7-25S-6.3A	CA7-9	65	50	30	~	65	~	~	~	~	~
11	KTA7-25S-10A	CA7-9	65	50	30	~	65	~	~	~	~	~
12	KTA7-25S-16A	CA7-12	30	~	30	~	65	~	~	~	~	~
14	KTA7-25S-16A	CA7-30	30	~	30	~	65	~	~	~	~	~
15	KTA7-25S-20A	CA7-16	30	~	30	~	10	~	~	~	~	~
16	KTA7-25S-25A	CA7-23	30	~	30	~	~	~	~	~	~	~
--	KTA7-32S-29A	CA7-30	30	10	30	~	~	~	~	~	~	~
--	KTA7-32S-32A	CA7-37	30	10	30	~	~	~	~	~	~	~
17	KTA7-25H-2.5A	CA7-9	65	65	30	~	65	65	30	10	65	~
18	KTA7-25H-2.5A	CA7-9	65	65	30	~	65	65	30	30	65	30
19	KTA7-25H-4A	CA7-9	65	65	30	~	65	65	30	~	~	~
21	KTA7-25H-4A	CA7-30	65	65	30	30	65	65	30	30	65	30
22	KTA7-25H-6.3A	CA7-9	65	65	30	~	65	65	30	~	~	~
23	KTA7-25H-6.3A	CA7-30	65	65	30	~	65	65	30	30	65	30
24	KTA7-25H-10A	CA7-9	65	65	30	~	65	65	30	~	~	~
27	KTA7-25H-10A	CA7-30	65	65	30	~	65	65	30	30	65	30
28	KTA7-25H-16A	CA7-12	65	65	30	~	65	65	30	~	~	~
30	KTA7-25H-16A	CA7-30	65	65	30	~	65	65	30	30	65	30
31	KTA7-25H-20A	CA7-23	65	65	30	~	65	65	~	~	~	~
32	KTA7-25H-20A	CA7-30	65	65	30	~	65	65	~	~	65	~
33	KTA7-25H-25A	CA7-23	65	65	30	~	65	65	~	~	~	~
34	KTA7-25H-25A	CA7-30	65	65	30	~	65	65	~	~	65	~
--	KTA7-32H-29A	CA7-30	65	65	30	~	~	~	~	~	~	~
--	KTA7-32H-32A	CA7-37	65	65	30	~	~	~	~	~	~	~
36	KTA7-45H-10A	CA7-30	65	65	30	30	65	65	30	30	65	30
37	KTA7-45H-16A	CA7-30	65	65	30	30	65	65	30	30	65	30
38	KTA7-45H-20A	CA7-30	65	65	30	30	65	65	30	30	65	30
39	KTA7-45H-25A	CA7-30	65	65	30	30	65	65	30	30	65	30
41	KTA7-45H-32A	CA7-30	65	65	30	30	65	65	30	30	65	30
45	KTA7-45H-45A	CA7-37	65	65	18	10	65	65	~	~	65	~
46	KTA7-45H-45A	CA7-43	65	65	18	10	65	65	~	~	65	~

Section Obsolete
See pages F1.40 - F1.55

F
ECombo Circuit Controllers

Gray type indicates non-cataloged assembly. Contact your Sprecher + Schuh representative for information.

① The ratings in these tables assume connection between components are made with Sprecher + Schuh Connection Modules.
Engineering Practice allows wire connection as an alternative.

KT7 Assembly – Application Rating Chart (Ratings are dependent on type of application) ❶❷

Rating Index	Assembly Components		Manual Controller or Group Installation				Combination Motor Controller (Type F)				Self-Protected Combination Motor Controller (Type E)	
			480V		600V		480Y / 277V		600Y / 347V		480Y / 277V	600Y / 347V
	KT7	Minimum Contactor Size	Type 1 KAIC	Type 2 KAIC	Type 1 KAIC	Type 2 KAIC	Type 1 KAIC	Type 2 KAIC	Type 1 KAIC	Type 2 KAIC	Type E KAIC	Type E KAIC
KTC7 + CA7 UL Assemblies ❶												
❶	KTC7-25S-0.16A	CA7-9...23	65	65	47	47	65	65	47	47	65	47
	KTC7-25S-0.25A	CA7-9...23	65	65	47	47	65	65	47	47	65	47
	KTC7-25S-0.4A	CA7-9...23	65	65	47	47	65	65	47	47	65	47
	KTC7-25S-0.63A	CA7-9...23	65	65	47	47	65	65	47	47	65	47
	KTC7-25S-1A	CA7-9...23	65	65	47	47	65	65	47	47	65	47
	KTC7-25S-1.6A	CA7-9...23	65	65	30	10	65	65	30	10	65	~
	KTC7-25S-2.5A	CA7-9...23	65	50	30	~	65	~	30	~	~	~
	KTC7-25S-2.5A	CA7-23	65	50	30	~	65	~	~	~	~	~
	KTC7-25S-4A	CA7-9...23	65	50	30	~	65	~	~	~	~	~
	KTC7-25S-6.3A	CA7-12...23	65	50	30	~	65	~	~	~	~	~
	KTC7-25S-10A	CA7-12...43	30	~	30	~	30	~	~	~	~	~
	KTC7-25S-16A	CA7-23	30	~	30	~	~	~	~	~	~	~
❶	KTC7-25H-16A	CA7-23	65	65	30	~	65	65	~	~	~	~
	KTC7-25H-16A	CA7-30	65	65	30	~	65	65	~	~	65	~
	KTC7-25H-20A	CA7-23	65	65	30	~	65	65	~	~	~	~
	KTC7-25H-20A	CA7-30	65	65	30	~	65	65	~	~	65	~
❶	KTC7-45H-25A	CA7-30	65	65	30	~	65	65	30	30	65	30
	KTC7-45H-32A	CA7-37	65	65	10	~	65	65	~	~	65	~

Section Obsolete
See pages F1.40 - F1.55

F
ECombo Circuit Controllers

❶ Non-cataloged assemblies. Contact your Sprecher+ Schuh representative for information.
 ❷ The ratings in these tables assume connection between components are made with Sprecher + Schuh Connection Modules. Engineering Practice allows wire connection as an alternative.

KT7 Assembly – Application Rating Chart (Ratings are dependent on type of application) ①

Rating Index	Assembly Components		Manual Controller or Group Installation				Combination Motor Controller (Type F)				Self-Protected Combination Motor Controller (Type E)	
			480V		600V		480Y / 277V		600Y / 347V		480Y / 277V	600Y / 347V
	KT7	Minimum Contactor Size	Type 1 KAIC	Type 2 KAIC	Type 1 KAIC	Type 2 KAIC	Type 1 KAIC	Type 2 KAIC	Type 1 KAIC	Type 2 KAIC	Type E KAIC	Type E KAIC
KT7 + CA8 UL Assemblies (CL8 / CLU8)												
--	KTA7-25S-(0.16A...1A)	CA8-05	65	65	47	~	65	~	47	~	~	~
--	KTA7-25S-1.6A	CA8-05	65	~	47	~	65	~	47	~	~	~
--	KTA7-25S-(2.5A...4A)	CA8-05	65	~	30	~	65	~	30	~	~	~
--	KTA7-25S-6.3A	CA8-05	65	~	~	~	65	~	~	~	~	~
1M	KTA7-25S-0.16A	CA8-09	65	65	47	~	65	65	47	~	~	~
2M	KTA7-25S-0.25A	CA8-09	65	65	47	~	65	65	47	~	~	~
3M	KTA7-25S-0.4A	CA8-09	65	65	47	~	65	65	47	~	~	~
4M	KTA7-25S-0.63A	CA8-09	65	65	47	~	65	65	47	~	~	~
5M	KTA7-25S-1A	CA8-09	65	65	47	~	65	65	47	~	~	~
6M	KTA7-25S-1.6A	CA8-09	65	65	47	~	65	65	47	~	~	~
7M	KTA7-25S-2.5A	CA8-09	65	~	30	~	65	~	30	~	~	~
8M	KTA7-25S-4A	CA8-09	65	~	30	~	65	~	30	~	~	~
9M	KTA7-25S-6.3A	CA8-09	65	~	30	~	65	~	30	~	~	~
10M	KTA7-25S-10A	CA8-09	65	~	30	~	65	~	30	~	~	~
--	KTA7-25S-(2.5A...4A)	CA8-12	65	~	~	~	65	~	30	~	~	~
--	KTA7-25S-6.3A	CA8-12	65	~	~	~	65	~	~	~	~	~
11M	KTA7-25S-10A	CA8-09	65	~	~	~	65	~	~	~	~	~
12M	KTA7-25S-16A	CA8-12	30	~	30	~	30	~	~	~	~	~

Section Obsolete
See pages F1.40 - F1.55

F
ECombo Circuit Controllers

Rating Index	Assembly Components		Self-Protected Combination Motor Controller (Type E KAIC) ②			
	KT7	Minimum Contactor Size	208V-240V	480Y / 277V	600Y / 347V	
KT7 + CA7 CEP7 UL Assemblies (CLT7 / CLU7)						
3B	KTB7-25S-0.4A	CA7-9	CEP7-ED1AB	65	65	47
3B	KTB7-25S-0.4A	CA7-9	CEP7-EEAB	65	65	47
5B	KTB7-25S-1A	CA7-9	CEP7-ED1BB	65	65	47
5B	KTB7-25S-1A	CA7-9	CEP7-EEBB	65	65	47
7B	KTB7-25S-2.5A	CA7-9	CEP7-ED1CB	65	65	~
7B	KTB7-25S-2.5A	CA7-9	CEP7-EECB	65	65	~
17B	KTB7-25H-2.5A	CA7-9	CEP7-ED1CB	65	65	~
17B	KTB7-25H-2.5A	CA7-9	CEP7-EECB	65	65	~
18B	KTB7-25H-2.5A	CA7-23	CEP7-ED1CB	65	65	30
18B	KTB7-25H-2.5A	CA7-23	CEP7-EECB	65	65	30
21B	KTB7-25H-4A	CA7-23	CEP7-ED1CB	65	65	30
21B	KTB7-25H-4A	CA7-23	CEP7-EECB	65	65	30
27B	KTB7-25H-10A	CA7-30	CEP7-EEED	65	65	30
30B	KTB7-25H-16A	CA7-30	CEP7-EEED	65	65	30
34B	KTB7-25H-25A	CA7-30	CEP7-EEED	65	65	~
39B	KTB7-45H-25A	CA7-30	CEP7-EEED	65	65	30
41B	KTB7-45H-32A	CA7-30	CEP7-EEFD	65	65	30
42B	KTB7-45H-32A	CA7-37	CEP7-EEFD	65	65	30
45B	KTB7-45H-45A	CA7-37	CEP7-EEFD	65	65	~
46B	KTB7-45H-45A	CA7-43	CEP7-EEFD	65	65	~

Definition of Type 2 short-circuit coordination per UL508

- The contactor or starter must not endanger persons or plant in the event of a short-circuit.
- The contactor or starter must be suitable for continuous use.
- No damage to the overload relay or other parts may occur with the exception of welding of the contactor or starter contacts if these can be easily separated without appreciable deformation (such as with a screwdriver).

In the event of a short-circuit, fast-opening, strong current-limiting KT7 motor protectors make it possible to build economical, fully short-circuit coordinated starter combinations in accordance with UL508E, Type 2 coordination.

Gray type indicates non-cataloged assembly. Contact your Sprecher+ Schuh representative for information.

① The ratings in these tables assume connection between components are made with Sprecher + Schuh Connection Modules. Engineering Practice allows wire connection as an alternative.

② UL approved, File 125316.

KT7 Assembly – IEC Application Rating Chart (Ratings are dependent on type of application) ①

Rating Index	Assembly Components		IEC kW Ratings for Standard Motors, 1500 rpm Max. kW, 50Hz ②				Max. Short-Circuit Current [kA] IEC Type 1 Coordination				Max. Short-Circuit Current [kA] IEC Type 2 Coordination			
	KT7	Min. Contactor	230V	400V	500V	690V	230V	400V	500V	690V	230V	400V	500V	690V
KT7 + CA7 IEC Assemblies (CL7 / CLU7/ CK7 / CKU7)														
1	KTA7-25S-0.16A	CA7-9	~	~	0.06	0.06	100	100	65	50	100	100	65	50
2	KTA7-25S-0.25A	CA7-9	0.02	0.06	0.06	0.12	100	100	65	50	100	100	65	50
3	KTA7-25S-0.4A	CA7-9	0.06	0.09	0.12	0.18	100	100	65	50	100	100	65	50
4	KTA7-25S-0.63A	CA7-9	0.09	0.18	0.18	0.37	100	100	65	50	100	100	65	50
5	KTA7-25S-1A	CA7-9	0.12	0.25	0.37	0.55	100	100	65	50	100	100	65	50
6	KTA7-25S-1.6A	CA7-9	0.25	0.55	0.75	1.1	100	100	65	50	100	100	65	50
7	KTA7-25S-2.5A	CA7-9	0.55	0.75	1.1	1.8	100	65	50	8	65	50	50	8
8	KTA7-25S-4A	CA7-9	0.75	1.5	2.2	3	100	50	50	8	50	50	~	~
9	KTA7-25S-6.3A	CA7-9	1.5	2.2	3	4	100	50	50	4	50	50	~	~
10	KTA7-25S-10A	CA7-9	2.2	4	4	~	100	65	50	~	50	50	~	~
11	KTA7-25S-10A	CA7-12	2.2	4	5.5	5.5	100	65	50	4	50	50	50	~
--	KTA7-25S-10A	CA7-16	2.2	4	5.5	7.5	100	65	50	4	50	50	50	~
12	KTA7-25S-16A	CA7-12	4	5.5	~	~	100	65	~	~	50	50	~	~
--	KTA7-25S-16A	CA7-16	4	7.5	7.5	~	100	50	10	~	50	~	~	~
14	KTA7-25S-16A	CA7-23	4	7.5	10	10	100	50	10	~	50	50	~	~
15	KTA7-25S-20A	CA7-23	4	10	11	~	50	15	~	~	15	~	~	~
16	KTA7-25S-25A	CA7-23	6.3	11	13	~	50	15	~	~	15	~	~	~
17	KTA7-25H-2.5A	CA7-9	0.55	0.75	1.1	8	100	100	50	10	100	100	50	10
18	KTA7-25H-2.5A	CA7-23	0.55	0.75	1.1	1.1	100	100	50	10	100	100	50	10
19	KTA7-25H-4A	CA7-9	0.75	1.5	2.2	3	100	100	50	10	100	100	50	~
21	KTA7-25H-4A	CA7-23	0.75	1.5	2.2	3	100	100	50	10	100	100	50	50
22	KTA7-25H-6.3A	CA7-9	1.5	2.2	3	4	100	100	50	50	100	100	50	~
--	KTA7-25H-10A	CA7-9	2.2	4	4	~	100	65	50	~	100	65	~	~
24	KTA7-25H-10A	CA7-12	2.2	4	5.5	5.5	100	100	65	50	100	100	65	~
--	KTA7-25H-10A	CA7-16	2.2	4	5.5	7.5	100	100	65	50	100	100	65	50
--	KTA7-25H-16A	CA7-12	4	5.5	~	~	100	65	~	~	65	65	~	~
28	KTA7-25H-16A	CA7-16	4	7.5	7.5	~	100	65	50	~	65	65	50	~
--	KTA7-25H-16A	CA7-23	4	7.5	10	10	100	65	50	6	65	65	50	~
31	KTA7-25H-20A	CA7-23	4	10	11	~	65	65	25	~	65	65	25	~
33	KTA7-25H-25A	CA7-23	6.3	11	13	~	65	50	25	~	65	50	25	~
KT7 + CA8 IEC Assemblies (CL8 / CLU8)														
1M	KTA7-25S-0.16A	CA8-09	~	0.02	~	~	100	65	65	65	65	65	~	~
2M	KTA7-25S-0.25A	CA8-09	0.02	0.06	0.06	~	100	65	65	65	65	65	~	~
3M	KTA7-25S-0.4A	CA8-09	0.06	0.09	0.12	~	100	65	65	65	65	65	~	~
4M	KTA7-25S-0.63A	CA8-09	0.09	0.18	0.18	~	100	65	65	65	65	65	~	~
5M	KTA7-25S-1A	CA8-09	0.12	0.25	0.37	~	100	65	65	65	65	65	~	~
6M	KTA7-25S-1.6A	CA8-09	0.25	0.55	0.75	~	100	65	65	10	65	65	~	~
7M	KTA7-25S-2.5A	CA8-09	0.55	0.75	1.1	~	100	65	65	8	65	65	~	~
8M	KTA7-25S-4A	CA8-09	0.75	1.5	2.2	~	100	65	65	8	50	50	~	~
9M	KTA7-25S-6.3A	CA8-09	1.5	2.2	2.2	~	100	65	65	4	~	~	~	~
10M	KTA7-25S-10A	CA8-09	2.2	4	4	~	100	65	65	4	~	~	~	~
11M	KTA7-25S-10A	CA8-12	2.2	4	4	~	100	65	65	4	~	~	~	~
12M	KTA7-25S-16A	CA8-12	4	5.5	~	~	100	50	50	3	~	~	~	~

Gray type indicates non-cataloged assembly. Contact your Sprecher+ Schuh representative for information.

① The ratings in these tables assume connection between components are made with Sprecher + Schuh Connection Modules. Engineering Practice allows wire connection as an alternative.

② kW ratings shown in the table are for reference. Final selection of the starter depends upon the actual motor full-load current and service factor.

ECombo Circuit Controllers

Section Obsolete
See pages F1.40 - F1.55

EcomboPlus Combination Starters

CK7-9...23

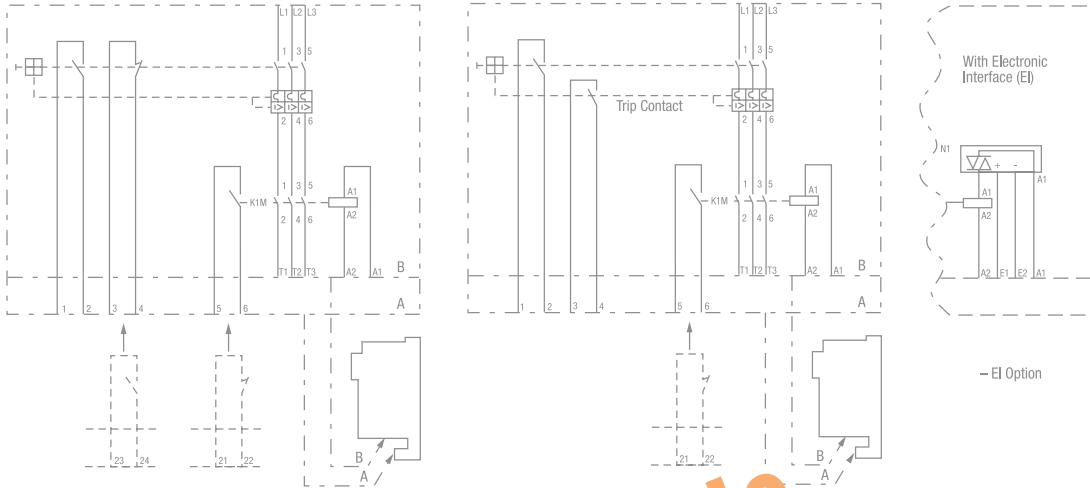

F
Ecombo Circuit Controllers

Section Obsolete
See pages F1.40 - F1.55

CK7-10...43

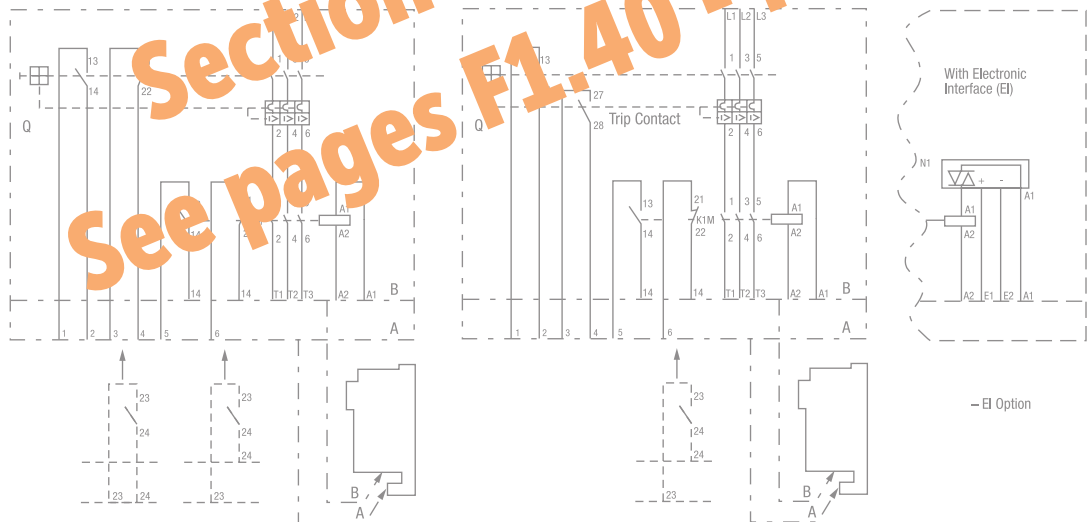

3-Component ECombo Starters

CLT7-9...43 Typical Diagram

CUSTOMER TO SUPPLY PROPER BRANCH
CIRCUIT PROTECTION AS PER LOCAL CODES.
(USE 75°C COPPER WIRE ONLY)

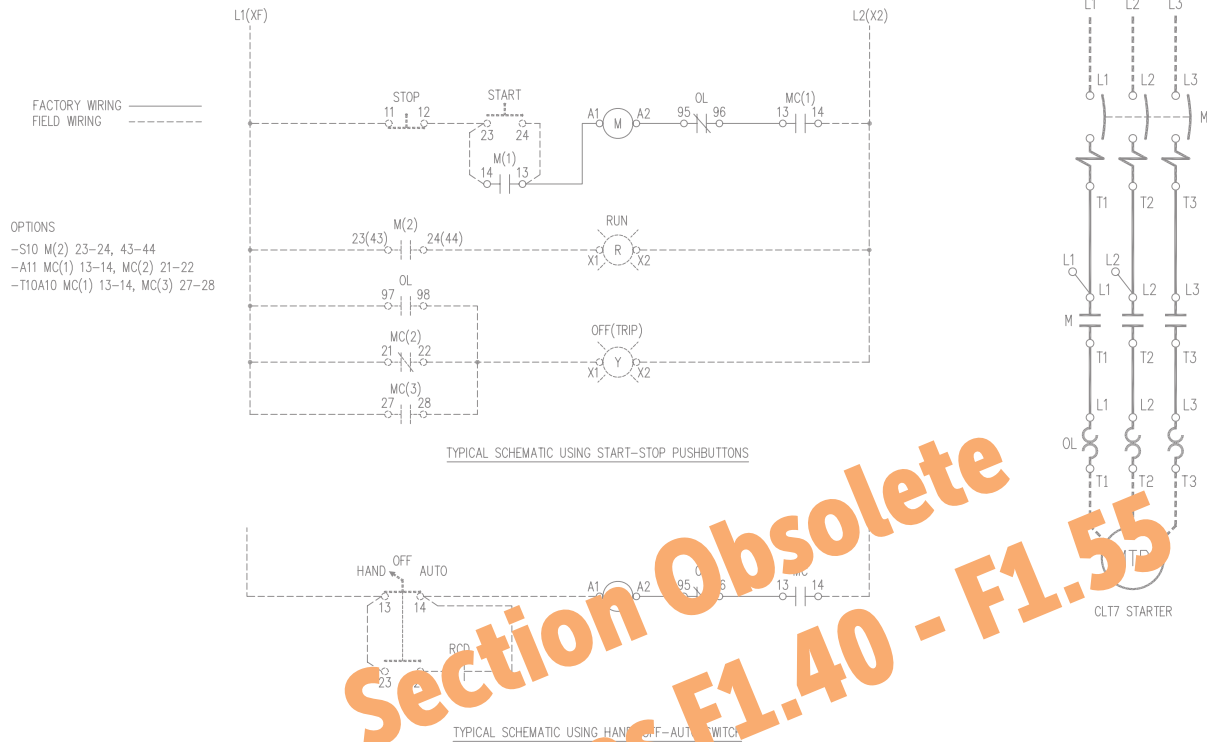

NOTES:

- 1) RCD: STANDS FOR REMOTE CONTROL DEVICE BY CUSTOMER.
- 2) MC: KTB7 MOTOR CONTROLLER.

Section Obsolete
See pages F1.40 - F1.55

F
ECombo Circuit Controllers

Ecombo Combination Starters

CL8 and CLU8 Ecombo Starters with KT7-25S

Dimensions are in millimeters (inches). Dimensions not intended for manufacturing purposes.

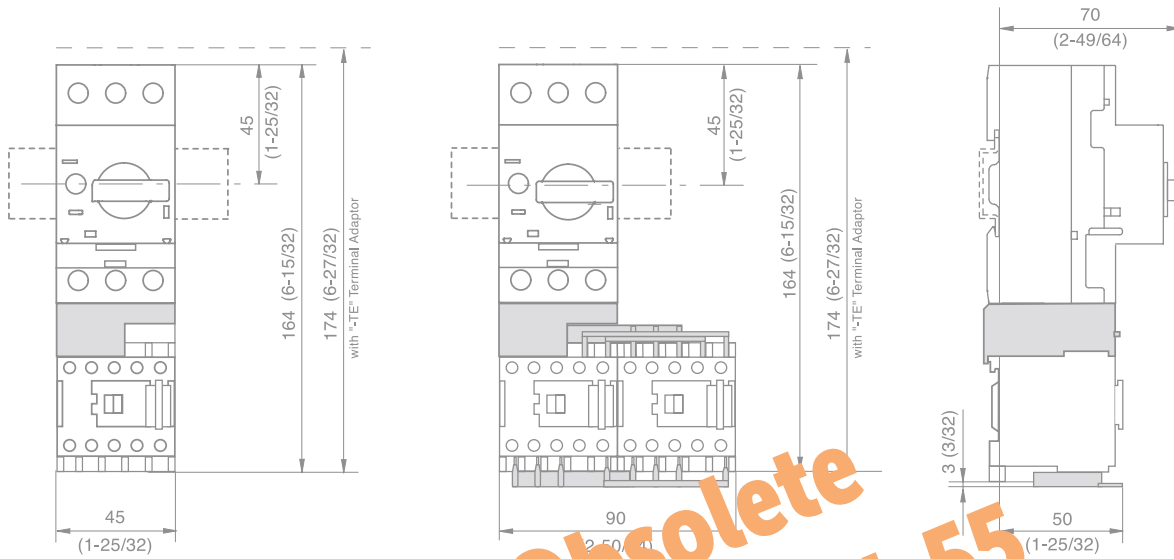

CL7-9...23(E) and CLU7-9...23(E) Ecombo Starters with KT7-25S

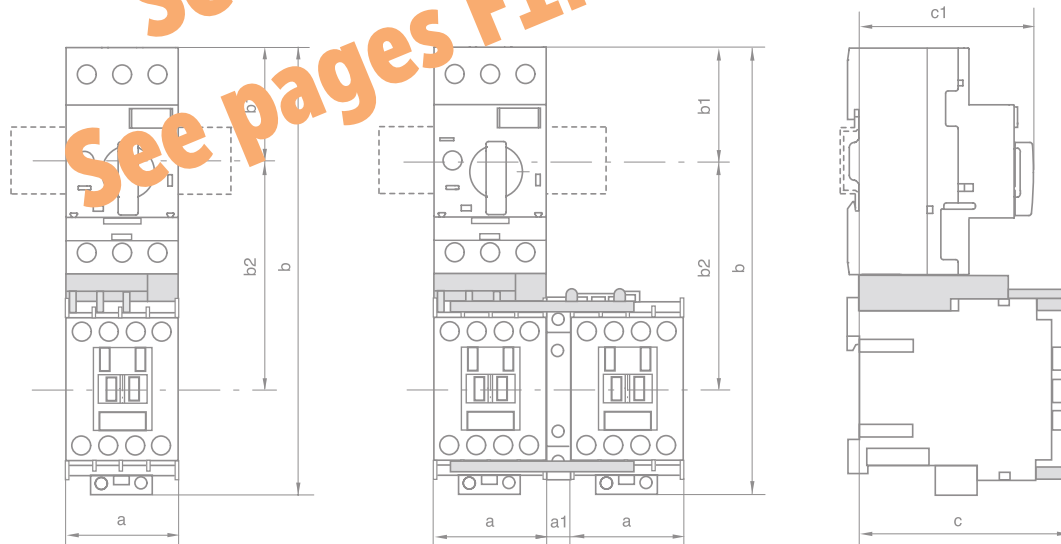

Catalog Number ❶	a	a1	b	b1	b2	c	c1
CL7-9(E)...CL7-23(E)	45 (1-25/32)	0	178 (7)	45 (1-25/32)	~	83.5 (3-19/64)	70 (2-49/64)
CL7-9(E)...CL7-23(E) with -TE1 Terminal Adaptor	45 (1-25/32)	0	188 (7-13/32)	55 (2-5/32)	~	83.5 (3-19/64)	70 (2-49/64)
CLU7-9(E)...CLU7-23(E)	45 (1-25/32)	10 (25/64)	178 (7)	45 (1-25/32)	~	83.5 (3-19/64)	70 (2-49/64)
CLU7-9(E)...CLU7-23(E) with -TE1 Terminal Adaptor	45 (1-25/32)	10 (25/64)	188 (7-13/32)	55 (2-5/32)	~	83.5 (3-19/64)	70 (2-49/64)

❶ Dimensions shown apply to AC coil contactors, or 12V or 24V Electronic DC coil contactors. Add 24 mm (1-25/32") to accommodate back pack on 36V...250V Electronic DC coils. See page A86 for details.

Ecombo Combination Starters

CL7-30...43(E) and CLU7-30...43(E) Ecombo Starters with KT7-45H

Dimensions are in millimeters (inches). Dimensions not intended for manufacturing purposes.

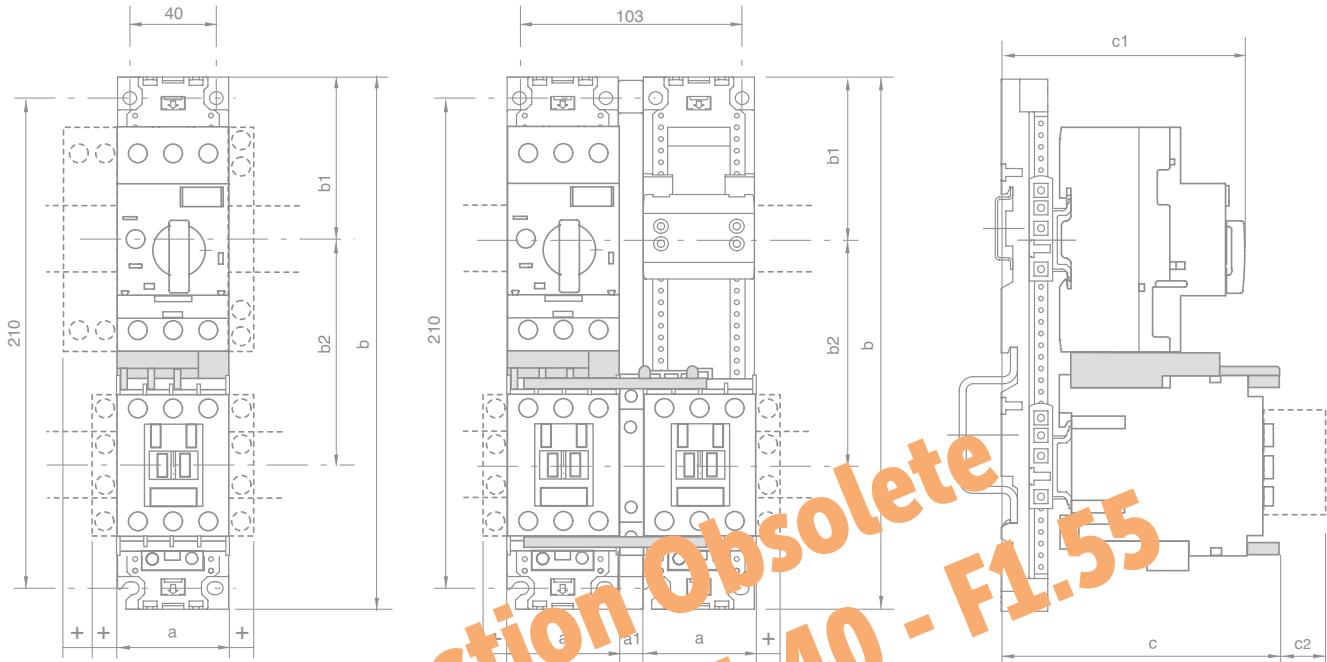

Catalog Number ①②	a	a1	b	b1	b2	c	c1	c2	+
CL7-30(E)	54 (2.125)	~	228 (8.97)	69 (2.72)	105 (4.30)	122.5 (4.82)	134.5 (5.29)	~	9
CL7-37(E)	54 (2.125)	~	228 (8.97)	69 (2.72)	105 (4.30)	122.5 (4.82)	134.5 (5.29)	~	9
CL7-43(E)	54 (2.125)	~	228 (8.97)	69 (2.72)	105 (4.30)	136 (5.35)	137 (5.39)	31 (1.22)	9
CLU7-30(E)	54 (2.125)	9	228 (8.97)	69 (2.72)	105 (4.30)	122.5 (4.82)	134.5 (5.29)	~	9
CLU7-37(E)	54 (2.125)	9	228 (8.97)	69 (2.72)	105 (4.30)	122.5 (4.82)	134.5 (5.29)	~	9
CLU7-43(E)	54 (2.125)	9	228 (8.97)	69 (2.72)	105 (4.30)	136 (5.35)	137 (5.39)	31 (1.22)	9

① CL7-30...43(E) and CLU7-30...43(E) include W-32490 Mounting Module. CLU7 includes W-32955 Spacer.

② Dimensions shown apply to AC coil contactors, or 12V or 24V Electronic DC coil contactors. Add 24 mm (1-25/32") to accommodate back pack on 36V... 250V Electronic DC coils. See page A86 for details.

Section Obsolete
See pages F1.40 - F1.55

F

Ecombo Circuit Controllers

EcomboPlus Combination Starters

CK7-9...23 and CKU7-9...23 EcomboPlus Starters

Dimensions are in millimeters (inches). Dimensions not intended for manufacturing purposes.

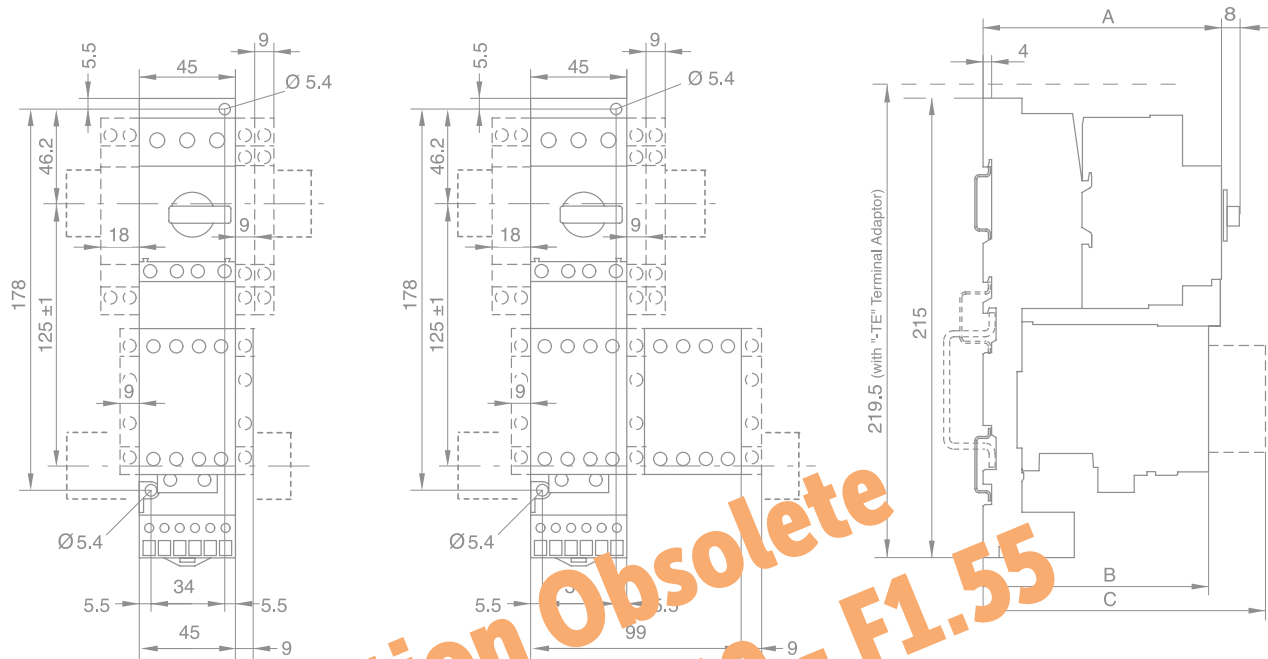

Section Obsolete
See pages F1.40 - F1.55

		A (mm)	B (mm)		
Direct on-line starters ①					
CK7-9(E)	KT7-25S	112	107	CA7-PV, CS7-PV CZE-7, CZA7 CV7	138 157 160
CK7-12(E)					
CK7-16(E)	KT7-25H	122			
CK7-23(E)					
Reversing Starters					
CKU7-9	KT7-25S	112	107	CA7-PV, CS7-PV CZE7, CZA7 CV7	138 157 160
CKU7-12					
CKU7-16	KT7-25H	122			
CKU7-23					

① Dimensions shown apply to AC coil contactors, or 12V or 24V Electronic DC coil contactors. Add 24 mm (1-25/32") to accommodate back pack on 36V...250V Electronic DC coils. See page A86 for details.

EcomboPlus Combination Starters

CK7-9...23

Dimensions are in millimeters (inches). Dimensions not intended for manufacturing purposes.

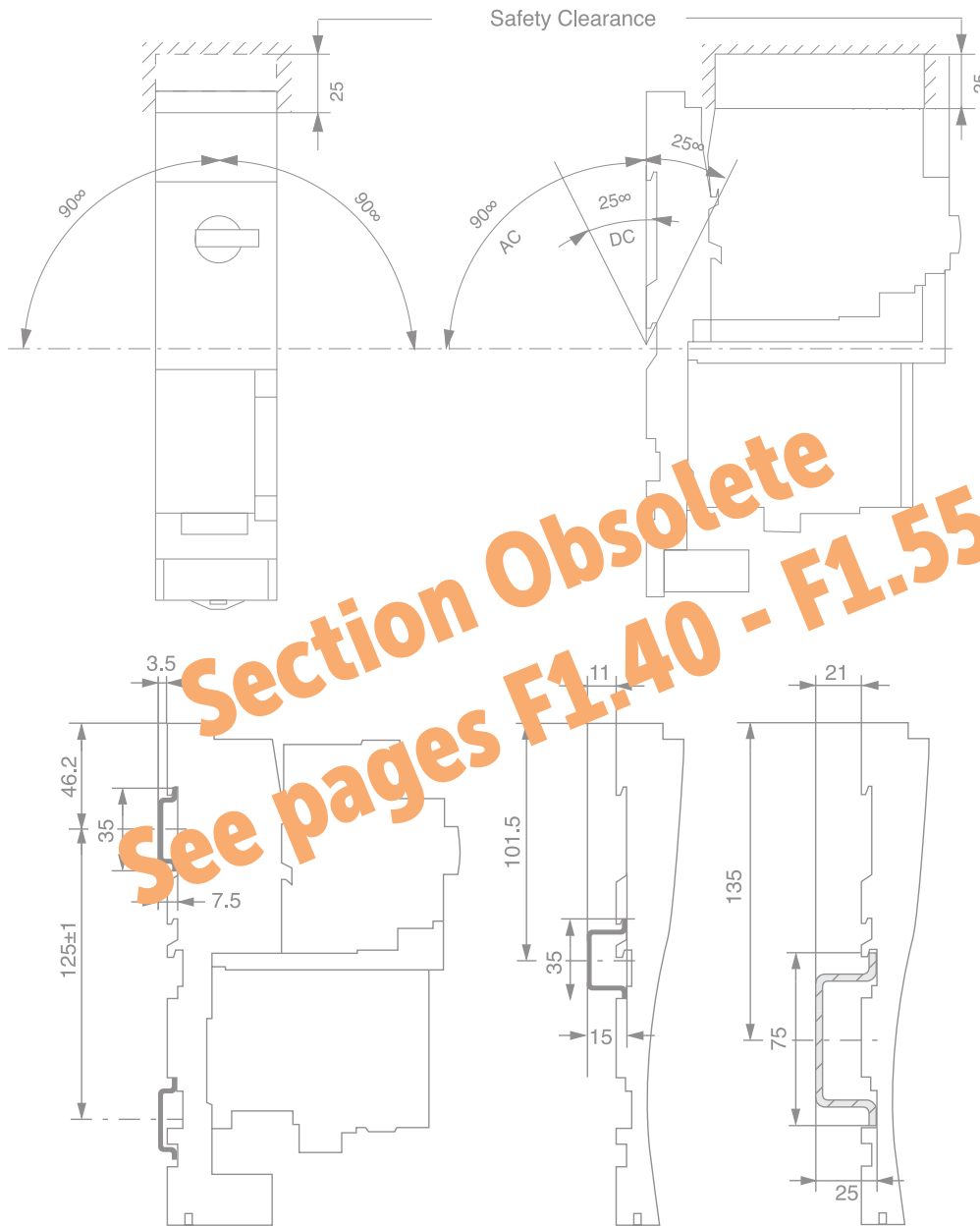

Section Obsolete
See pages F1.40 - F1.55

F

Ecombo Circuit Controllers

EcomboPlus Combination Starters

CK7-30...37

Dimensions are in millimeters (inches). Dimensions not intended for manufacturing purposes.

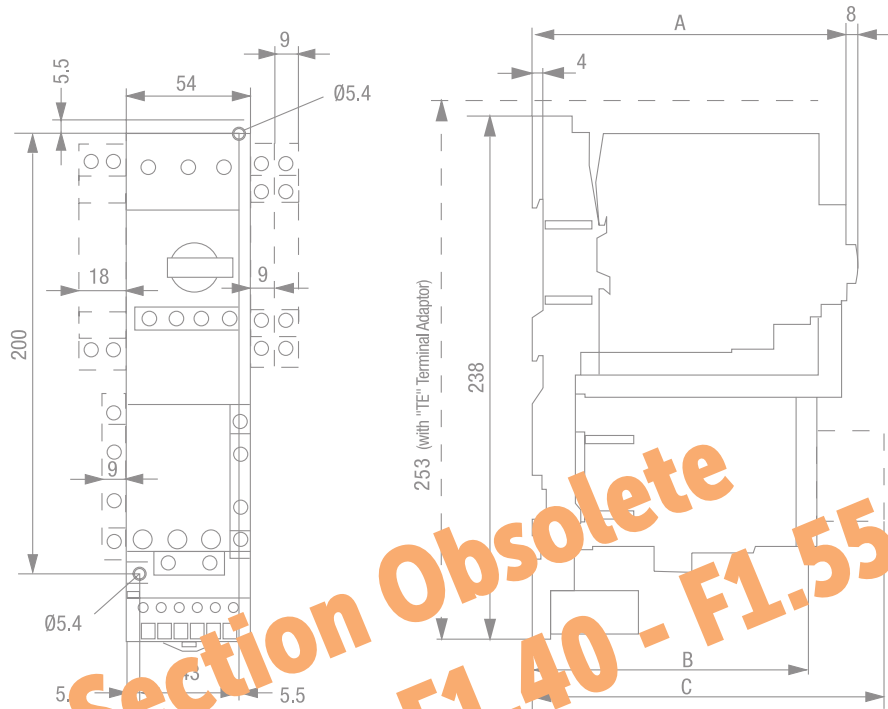

Section Obsolete
See pages F1.40 - F1.55

		A (mm)		B (mm)		C (mm)	
CK7-30(E) ①	KT7-45H	135	124			CA7-PV	154.5
CK7-37(E) ①						CZE7	173.5
						CV7	176.5

① Dimensions shown apply to AC coil contactors, or 12V or 24V Electronic DC coil contactors. Add 24 mm (1-25/32") to accommodate back pack on 36V...250V Electronic DC coils. See page A86 for details.

EcomboPlus Combination Starters

CK7-43

Dimensions are in millimeters (inches). Dimensions not intended for manufacturing purposes.

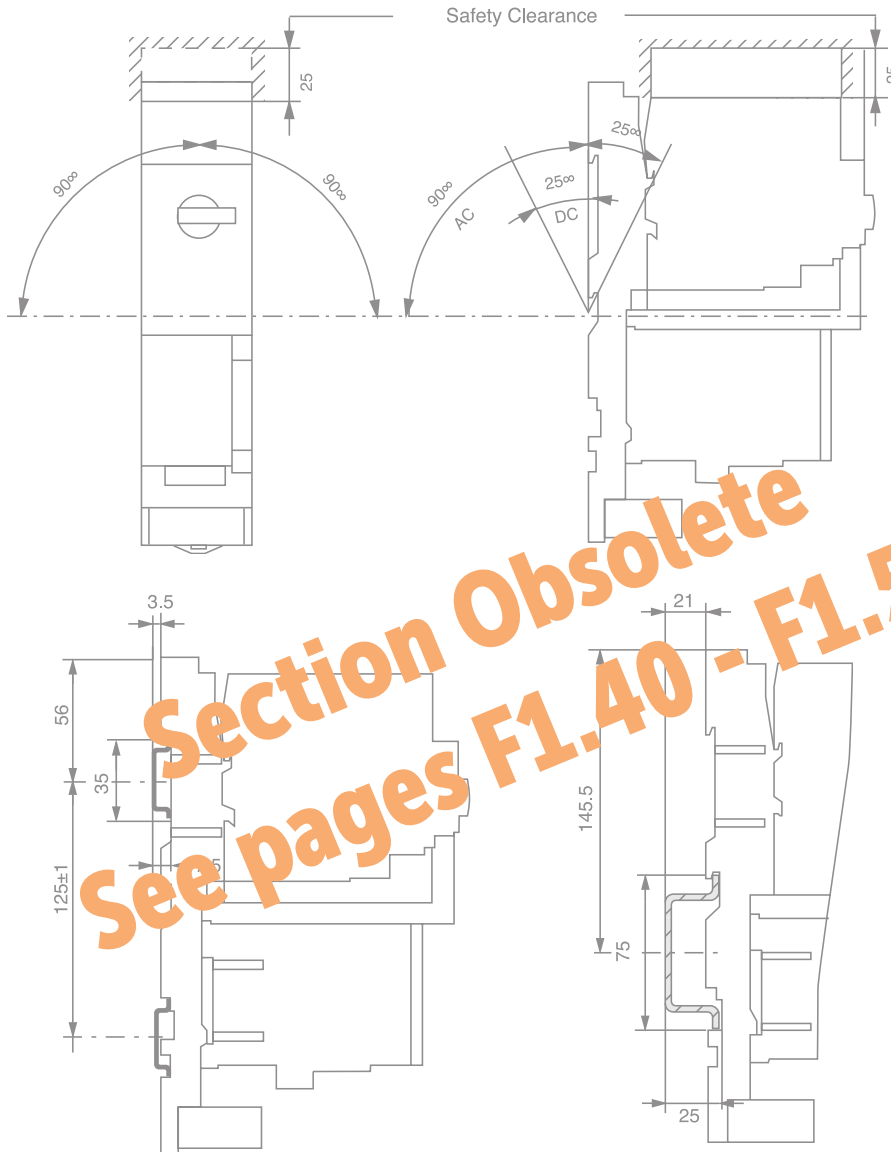

Section Obsolete
See pages F1.40 - F1.55

See previous page for dimensions A , B & C locations

		A (mm)	B (mm)
		135	118.5

	C (mm)
	157
	176
	179

① Dimensions shown apply to AC coil contactors, or 12V or 24V Electronic DC coil contactors. Add 24 mm (1-25/32") to accommodate back pack on 36V...250V Electronic DC coils. See page A86 for details.

Non-Reversing Three Component Combination Starters ③

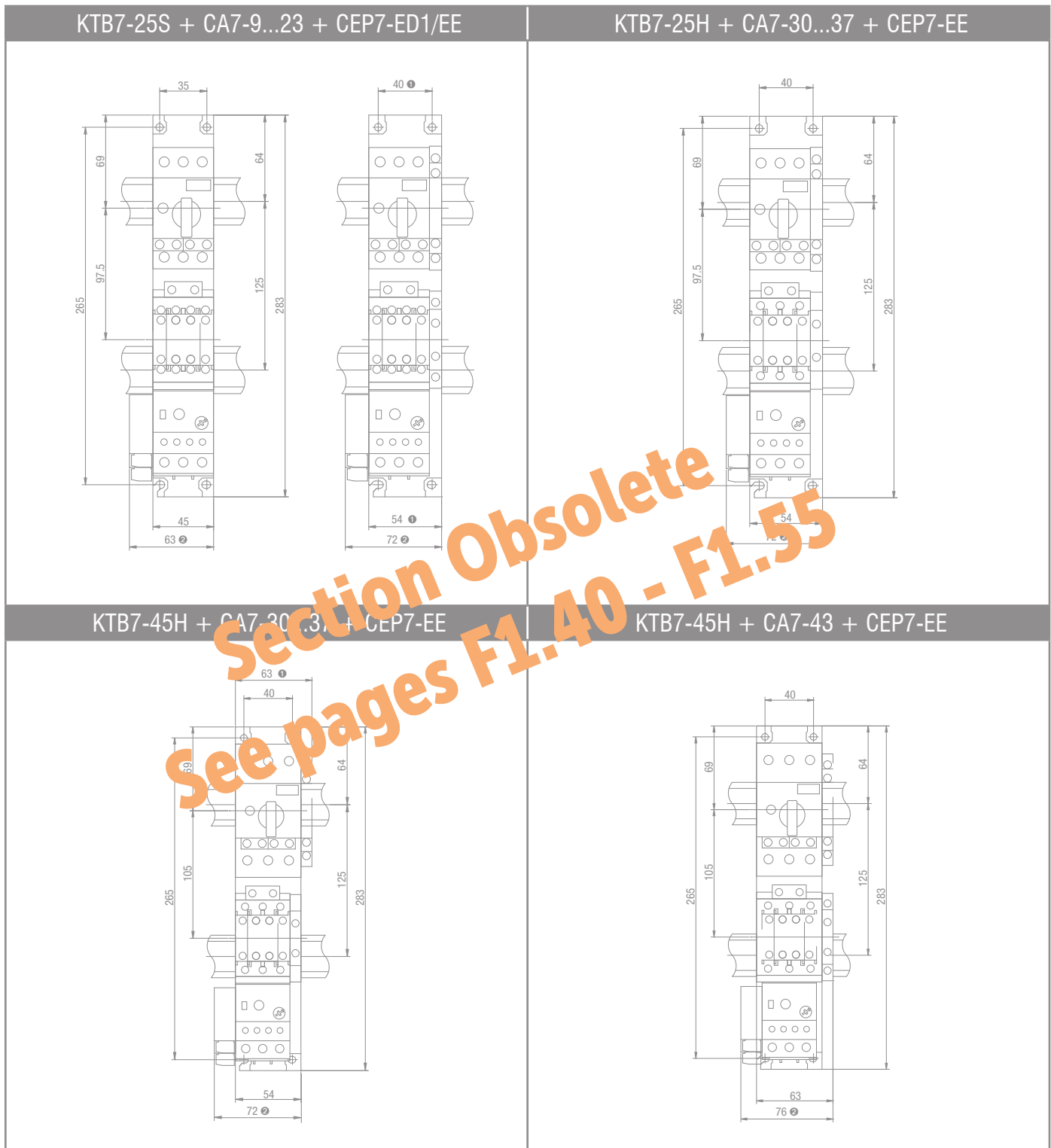

Section Obsolete
See pages F1.40 - F1.55

Dimensions are in millimeters (inches). Dimensions not intended for manufacturing purposes.

- ① With additional side mount auxiliary or trip contact(s)
- ② With CEP7-E* Side Mount Modules
- ③ Dimensions shown apply to AC coil contactors, or 12V or 24V Electronic DC coil contactors. Add 24 mm (1-25/32") to accommodate back pack on 36V...250V Electronic DC coils. See page A86 for details.

Reversing Three Component Combination Starters ②

KTB7-25S + CAU7-9...37 + CEP7-ED1/EE

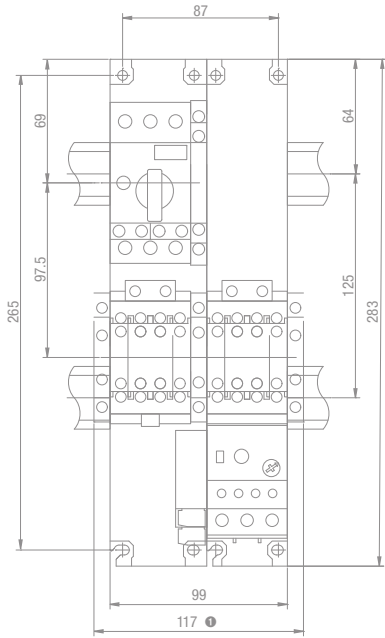

KTB7-45H + CA7-30...37 + CEP7-EE

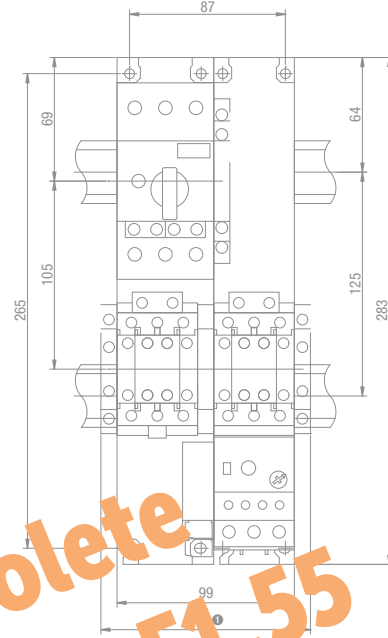

KTB7-45H + CA7-43...37 + CEP7-EE

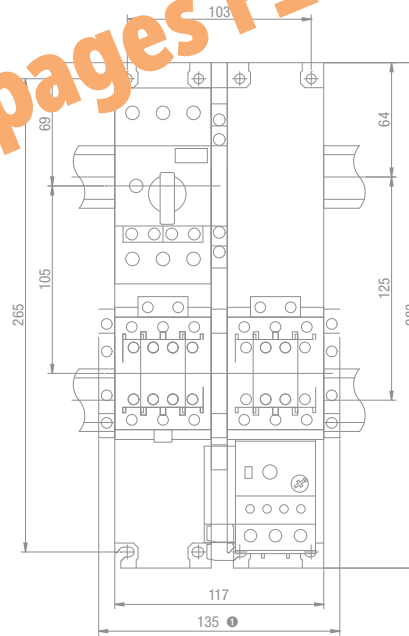

Section Obsolete
See pages F1.40 - F1.55

Dimensions are in millimeters (inches). Dimensions not intended for manufacturing purposes.

- ① With additional side mount auxiliary contact(s)
- ② Dimensions shown apply to AC coil contactors, or 12V or 24V Electronic DC coil contactors. Add 24 mm (1-25/32") to accommodate back pack on 36V...250V Electronic DC coils. See page A86 for details.

Notes

**Section Obsolete
See pages F1.40 - F1.55**

F

ECombo Circuit Controllers