

Series KTU7 UL489 Molded Case Circuit Breakers

DISCONTINUED

Sprecher+Schuh's KTU7 series of UL Molded Case Circuit Breakers are UL489 and CE listed for global applications. The current limiting circuit breaker provides fixed short circuit and overcurrent protection and offers high interrupting ratings for 2- and 3-pole devices from 0.5 to 30A. These Circuit breakers are 100% rated up to 10A.

Versatile, convenient and space saving... for a variety of applications

Accessories are intelligently designed to be field installed. The compact busbars and supply blocks reduce wiring errors and installation labor cost. Connection modules for the CA7 Contactors simplify wiring and can reduce the number of DIN rails required, compacting panel space even further.

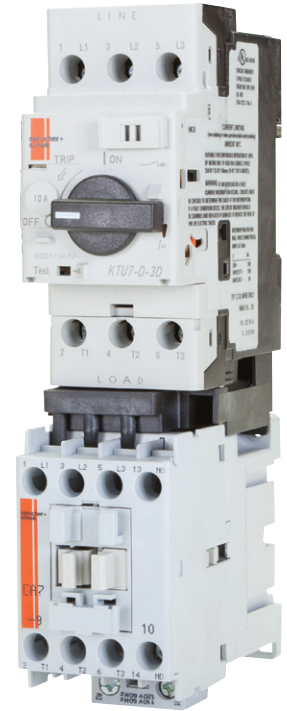

Advantages...

- Small foot print saves panel space, just 45 x 102 x 85 mm, up to 50% smaller than traditional MCCBs.
- Interrupt rating of 65kA at 480Y/277V may allow higher overall panel short circuit rating
- Up to 6 times higher interrupting rating vs. traditional miniature circuit breakers.



Ideal Applications...

- Feeder Circuits for small cabinets, distribution panels, branch circuit protection, transformers and heaters
- Control circuits for control circuit transformers and power supplies
- Industrial Heating applications
- Air conditioning and refrigeration applications

Compare these advanced features



F
KTU7 Molded Case Circuit Breakers

KTU7 Circuit Breaker, Fixed Thermal-Magnetic ②

Fixed Thermal Current Rating [A]	Magnetic Trip [A]	Interrupting Rating (60Hz) [KA]			Catalog Number
		240V	480Y/277V	600Y/347V	
KTU7-D — High Interrupting Capacity – 2-Pole					
0.5	15...20xIn	100	100	50	KTU7-D-2D-0.5 ①
1.0	15...20xIn	100	100	50	KTU7-D-2D-1 ①
2.0	15...20xIn	100	100	50	KTU7-D-2D-2 ①
3.0	15...20xIn	100	100	50	KTU7-D-2D-3 ①
4.0	15...20xIn	100	100	50	KTU7-D-2D-4 ①
5.0	15...20xIn	100	100	50	KTU7-D-2D-5 ①
6.0	15...20xIn	100	100	50	KTU7-D-2D-6 ①
8.0	15...20xIn	100	100	50	KTU7-D-2D-8 ①
10.0	15...20xIn	100	100	50	KTU7-D-2D-10 ①
12.0	15...20xIn	65	65	25	KTU7-D-2D-12
15.0	15...20xIn	65	65	25	KTU7-D-2D-15
20.0	15...20xIn	65	65	25	KTU7-D-2D-20
25.0	15...20xIn	65	65	25	KTU7-D-2D-25
30.0	15...20xIn	65	65 <td 25	KTU7-D-2D-30	
KTU7-D — High Interrupting Capacity – 3-Pole					
0.5	15...20xIn	100	100	50	KTU7-D-3D-0.5 ①
1.0	15...20xIn	100	100	50	KTU7-D-3D-1 ①
2.0	15...20xIn	100	100	50	KTU7-D-3D-2 ①
3.0	15...20xIn	100	100	50	KTU7-D-3D-3 ①
4.0	15...20xIn	100	100	50	KTU7-D-3D-4 ①
5.0	15...20xIn	100	100	50	KTU7-D-3D-5 ①
6.0	15...20xIn	100	100	50	KTU7-D-3D-6 ①
8.0	15...20xIn	100	100	50	KTU7-D-3D-8 ①
10.0	15...20xIn	100	100	50	KTU7-D-3D-10 ①
12.0	15...20xIn	65	65	25	KTU7-D-3D-12
15.0	15...20xIn	65	65	25	KTU7-D-3D-15
20.0	15...20xIn	65	65	25	KTU7-D-3D-20
25.0	15...20xIn	65	65	25	KTU7-D-3D-25
30.0	15...20xIn	65	65	25	KTU7-D-3D-30

Description

The KTU7 is a fixed trip, thermal-magnetic UL489 Molded Case Circuit Breaker.



KTU7-D-2D-10



KTU7-D-3D-10

F

KTU7 Molded Case Circuit Breakers

① Suitable for continuous operation at 100% of rating only if used in minimum enclosure space of 250 x 175 x 150 mm (10 x 7 x 6 in).
 ② KTU7 has independent thermal elements suitable for power distribution applications (not two slide bar differential tripping).

KT7 Accessories available for KTU7-D

	<p>KT7-PE1 or KT7-PEF1 Front Mount Auxiliaries and Trip Contacts See page F12</p>		<p>KT7-KN1, KT7-KRY1 or KT7-DS Lockable Twist Knob & Locking Tag See page F16</p>
	<p>KT7-UA or KT7-AA Undervoltage Trips and Shunt Trips ❶ See page F14</p>		<p>Handle Assemblies KT7-SY or KT7-SB KT7-HTN or KT7-HTRY ❷ See page F15</p>
	<p>KT7-HT/HTL, KT7-S_/N_ & KT7-SHS Extension Shafts & Support See page F15</p>		<p>KT7-45-AS Screw Adaptor See page F16</p>

F

KTU7 Molded Case Circuit Breakers

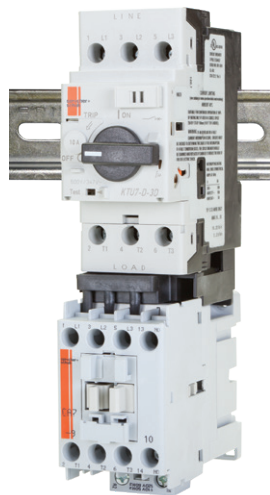

Remote Operation Application

The KTU7 3-Pole unit can be combined with CA7 using Connector Modules to achieve remote operation.

- For CA7-9...23 use KTU7-D-PEC23
- For CA7-9...43 use KTU7-D-PF



Extension Shaft Support Assembly



The KT7-SHS is recommended for handle shafts KT7-HT_ or KT7-S_/N_ in lengths greater than 200mm (7.8 inches).

See page F41

❶ Series B or later.
❷ Series E or later.

DISCONTINUED



Connecting Modules (for connecting KTU7 to CA7 AC coil, or CA7 Electronic DC coil contactors)

Module	Description	For Connecting. . .	To Contactor. . .	Catalog Number
	Connecting Modules <ul style="list-style-type: none"> • 25 Amp maximum • Provides electrical and mechanical interconnection of KTU7 3-Pole and CA7 (with AC coils) or CA7- _E (with 12V or 24V Electronic DC coils) • KTU7 and Contactor mount on one DIN rail (see previous page for visual) 	KTU7-D	CA7-9..23	KTU7-D-PEC23 ❶
	Flexible Connecting Module <ul style="list-style-type: none"> • 32 Amp maximum • Provides electrical and mechanical interconnection of KTU7 and CA7 (with AC coils) or CA7- _E (with 12V or 24V Electronic DC coils) • Contactor and KTU7 separately mounted 	KTU7-D	CA7-9..43	KTU7-D-PF ❶

F

KTU7 Molded Case Circuit Breakers

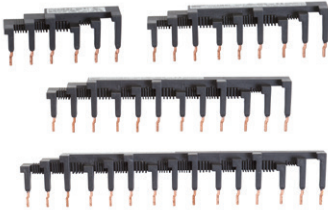
Compact Busbar System for KTU7-D

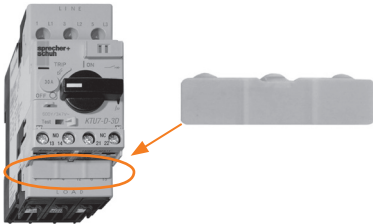
Accessory	Description	For Use With	Catalog Number
	Compact Busbar — 45 mm Spacing (Rated 64 A) <ul style="list-style-type: none"> • For use with front-mounted auxiliary contact Connects 2-KTU7s Connects 3-KTU7s Connects 4-KTU7s Connects 5-KTU7s (shown) 	KTU7-D-3D ❶	KTU7-D-DB-45-2 KTU7-D-DB-45-3 KTU7-D-DB-45-4 KTU7-D-DB-45-5
	Supply Block and Terminal <ul style="list-style-type: none"> • For power connection to Compact Busbar — 600V, KTU7-D...120A maximum • Top feed — overlaps commoning link • Meets requirements for terminal spacing from source • Compliant with UL489 Terminal Clearance standards 	KTU7-D-3D ❶	KTU7-D-A3E
	Load Terminal Cover <ul style="list-style-type: none"> • For UL 489 compliance of front mounted auxiliary contacts when installed on KTU7 • The cover packaged in quantities of 10 (must order 10 for one package of 10) 	KTU7	KT7-PEFC

❶ For use with KTU7 3-pole Circuit Breakers only.

Application Rating Chart

KTU7	High Fault SCCR			Switching Lighting Rated		
	Combined with ❶	480Y/277 VAC (KA)	600Y/347 VAC (KA)	Fluorescent ❷	High-intensity Discharge ❸	HVAC Rated ❹
KTU7-D-2D-0.5	CA7-9...23	65	35	~	HID	HARC
KTU7-D-2D-1	CA7-9...23	65	35	~	HID	HARC
KTU7-D-2D-2	CA7-9...23	65	35	~	HID	HARC
KTU7-D-2D-3	CA7-9...23	65	35	~	HID	HARC
KTU7-D-2D-4	CA7-9...23	65	35	~	HID	HARC
KTU7-D-2D-5	CA7-9...23	65	35	~	HID	HARC
KTU7-D-2D-6	CA7-9...23	65	35	~	HID	HARC
KTU7-D-2D-8	CA7-9...23	65	35	~	HID	HARC
KTU7-D-2D-10	CA7-9...23	65	35	~	HID	HARC
KTU7-D-2D-12	CA7-9...23	65	35	~	HID	HARC
KTU7-D-2D-15	CA7-9...23	65	35	SWD	HID	HARC
KTU7-D-2D-20	CA7-9...23	65	35	SWD	HID	HARC
KTU7-D-2D-25	CA7-9...30	65	35	~	HID	HARC
KTU7-D-2D-30	CA7-9...30	65	35	~	~	HARC
KTU7-D-3D-0.5	CA7-9...23	65	35	~	HID	HARC
KTU7-D-3D-1	CA7-9...23	65	35	~	HID	HARC
KTU7-D-3D-2	CA7-9...23	65	35	~	HID	HARC
KTU7-D-3D-3	CA7-9...23	65	35	~	HID	HARC
KTU7-D-3D-4	CA7-9...23	65	35	~	HID	HARC
KTU7-D-3D-5	CA7-9...23	65	35	~	HID	HARC
KTU7-D-3D-6	CA7-9...23	65	35	~	HID	HARC
KTU7-D-3D-8	CA7-9...23	65	35	~	HID	HARC
KTU7-D-3D-10	CA7-9...23	65	35	~	HID	HARC
KTU7-D-3D-12	CA7-9...23	65	35	~	HID	HARC
KTU7-D-3D-15	CA7-9...23	65	35	~	HID	HARC
KTU7-D-3D-20	CA7-9...23	65	35	~	HID	HARC
KTU7-D-3D-25	CA7-9...30	65	35	~	HID	HARC
KTU7-D-3D-30	CA7-9...30	65	35	~	HID	HARC

IEC Performance Data

(CSA C22.2, UL 489, IEC / EN 60947-1, -2 in connection with a short-circuit protection device)







		KTU7-D- 2 pole & 3 pole													
		0.5A	1A	2A	3A	4A	5A	6A	8A	10A	12A	15A	20A	25A	30A
Rated Operational Current I_n	[A]	0.5	1	2	3	4	5	6	8	10	12	15	20	25	30
Fixed Thermal Trip $I_t = I_n$	[A]	0.5	1	2	3	4	5	6	8	10	12	15	20	25	30
Fixed Magnetic Trip $I_m =$	[A]	15...20 x I_n													
Ultimate Short Circuit Breaking Capacity (50 Hz) I_{cu}		230...240V [kA]	100	100	100	100	100	100	100	100	100	100	100	100	100
		400...415V [kA]	100	100	100	100	100	100	100	100	65	65	65	65	65
		525V [kA]	65	65	65	65	65	65	65	65	65	65	65	65	65
		690V [kA]	50	50	18	18	18	18	10	10	10	10	10	10	10
Rated Service Short Circuit Breaking Capacity (50 Hz) I_{cs}		230...240V [kA]	100	100	100	100	100	100	100	100	100	100	100	100	100
		400...415V [kA]	65	65	65	65	65	65	65	65	50	50	50	50	50
		525V [kA]	65	65	65	65	65	65	65	65	50	50	50	25	25
		690V [kA]	50	50	10	10	10	10	6	6	6	6	6	6	6



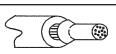
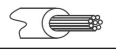

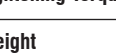
- ❶ KTU7 + CA7-9...23 contactor maybe combined with CEP7 overload. SCCR ratings remain unchanged.
- ❷ KTU7 circuit breaker intended to switch fluorescent lighting on a regular basis. Selection of sizes limited by UL489. Devices marked with "SWD".
- ❸ KTU7 Circuit Breakers intended to switch high-intensity discharge (ballast) lighting devices marked with "HID".
- ❹ Rated for use with heating, air conditioning, refrigeration. Devices marked with "HARC".

General Data

		KTU7-D
Number of Poles		2 and 3
Rated Insulation Voltage U_i		
IEC, / EN	[V]	600
UL, CSA	[V]	600
Ratings		HACR
Suitable for continuous operation at 100% of rating only if used in enclosure space for		0.5...15 A, enclosure space 250 x 175 x 150 mm (10 x 7 x 6 in)
Rated Impulse Withstand Voltage U_{imp}		
Pollution degree		3
Main circuits U _{imp} /Overvoltage Category		6 kV/III
Auxiliary circuits U _{imp} /Overvoltage Category		6 kV/III
Safe separation between main and auxiliary circuits		up to 400V
Rated Frequency	[Hz]	50/60
Utilization Category		
• IEC 60947-2 (Circuit Breaker)		A
Life Span		
Mechanical	[operations]	100,000
Electrical (I _e max.)	[operations]	10,000
Switching Frequency	[operations/h]	max. 25
Ambient Temperature		
Storage	[°C]	-40...+80
Operation	[°C]	-25...+60 (70 with 15% I _n current reduction)
Resistance to Climatic Change		
Moisture / Heat Resistance	(600068-2-30)	23 °C / 83 % relative humidity and 40 °C / 92 % relative humidity, 56 cycles
Dry Heat	(60086-2-2)	100 °C, relative humidity <50 %, 7 days
Moisture / Change Resistance	(60086-2-3)	40 °C, relative humidity 93 %, 56 days
Site Altitude	[m]	to 2000 N.N.
Protection Class		IP2X, when wired
Resistance to Shock	Transport (60068-2-27)	30 g, 11 ms, all axes
Resistance to Vibration	Operation (60068-2-6)	18 g
Overload Protection		
Phase-loss protection		No phase loss protection
Short circuit protection (Magnetic)		Fixed setting 10...20 x I _n
Main Disconnect Switch Application		Yes, with accessories
For utilization outside North America, Assemblies (of products) shall comply to the IEC61439-1 requirements		
Application Conditions	KTU7 circuit breakers are intended for use in closed areas without hazardous operating conditions such as dust or explosive or corrosive gases. Enclosures of appropriate manner need to be in place to protect devices in such environments.	
Standards	UL489; CSA C22.2 No. 5; IEC / EN 60947-1, -2	
Certifications	CE; cULus listed Circuit Breaker, File No. E334037 and E33916 (accessories)	

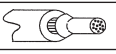
Terminal Specifications

		KTU7-D	
Terminal Parts			
Terminal Type		Pozidrive No. 2 / Blade No. 3	
Screwdriver		Pozidrive No. 2 / Blade No. 3	
	1. conductor	[mm ²]/[AWG]	1...6/—
	2. conductor	[mm ²]/[AWG]	1...4/—
	1. conductor	[mm ²]/[AWG]	1...6/—
	2. conductor	[mm ²]/[AWG]	1...6/—
	1. conductor	[mm ²]/[AWG]	—/No. 18...10
	2. conductor	[mm ²]/[AWG]	—/No. 18...10
	1. conductor	[mm ²]/[AWG]	1...6/No. 18...10
	2. conductor	[mm ²]/[AWG]	1...6/No. 18...10
Tightening Torque		[N•m] [lb•in]	2...2.5/18...22
Weight		[g]	395

		KTU7-D-A3E	
Use 75 °C Cu wire only			
Rated Thermal Current I_{th}		[A]	64
	1. conductor	[mm ²]/[AWG]	2.5...25/14...4
	1. conductor	[mm ²]/[AWG]	2.5...25/14...4
	1. conductor	[mm ²]/[AWG]	2.5...25/14...4
	1. conductor	[mm ²]/[AWG]	2.5...25/14...4
Tightening Torque		[N•m] [lb•in]	3...3.5/27...31

Time-Current Characteristic

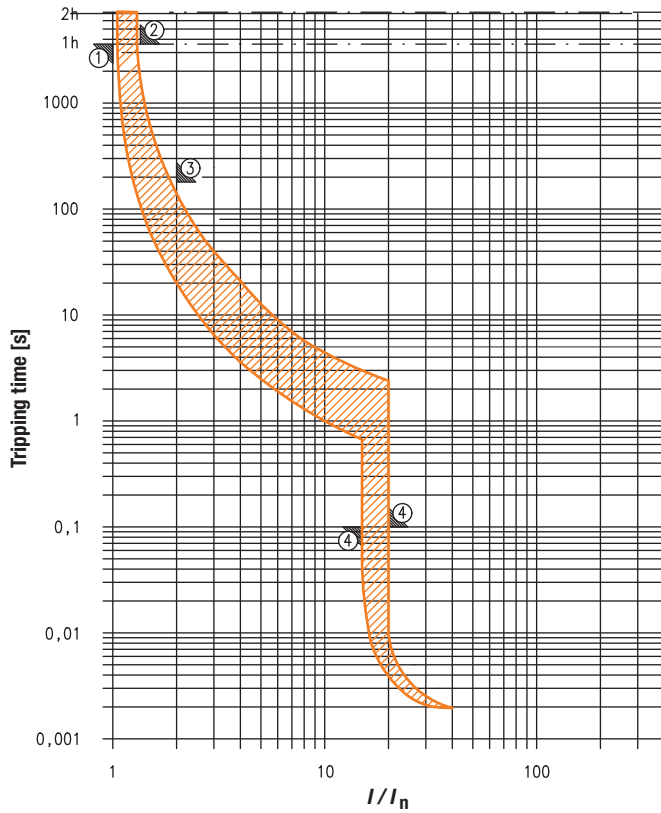

Tripping characteristic acc. to UL 489 and IEC 60947-2

- ① conventional non-tripping current $I_{nt} = 1.0 I_n$
- ② conventional tripping current $I_t = 1.35 I_n : t = < 1h$
- ③ $2.0 I_n : t = 180s \text{ max.}$

Instantaneous tripping acc. to UL 489 and IEC 60947-2

- ④ Trip Curve : $15 \dots 20 I_n$

Maximum Cut-off (Let-Through) Current

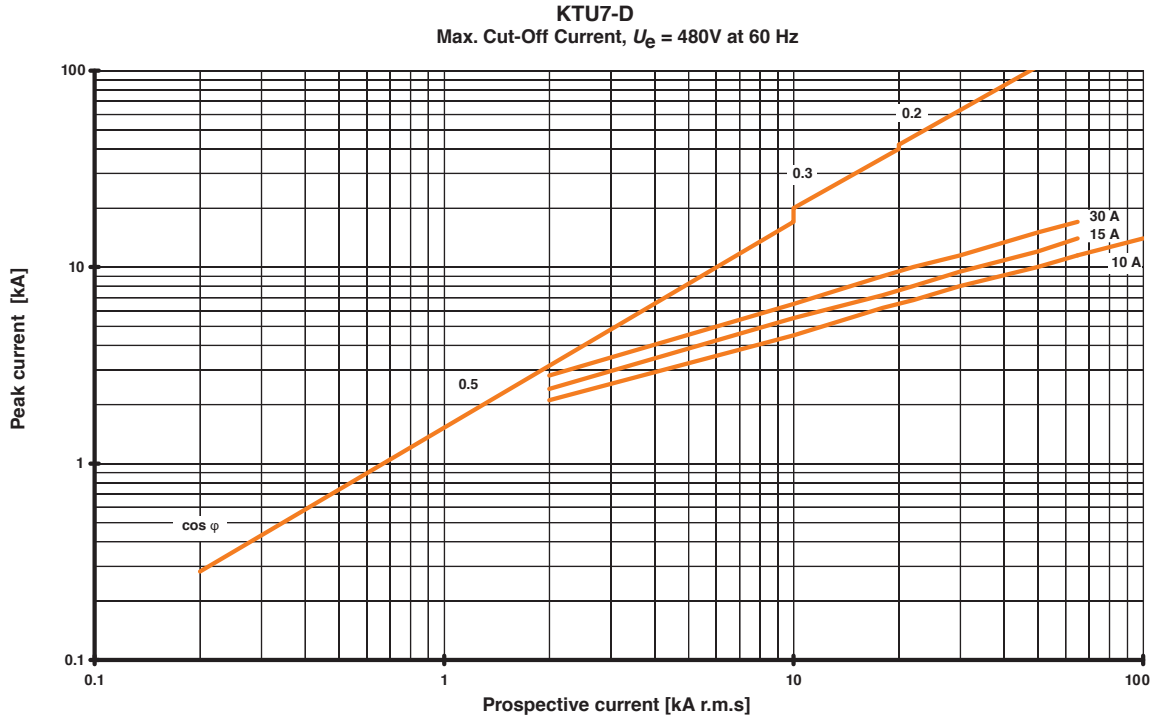

Maximum Let-Through Energy

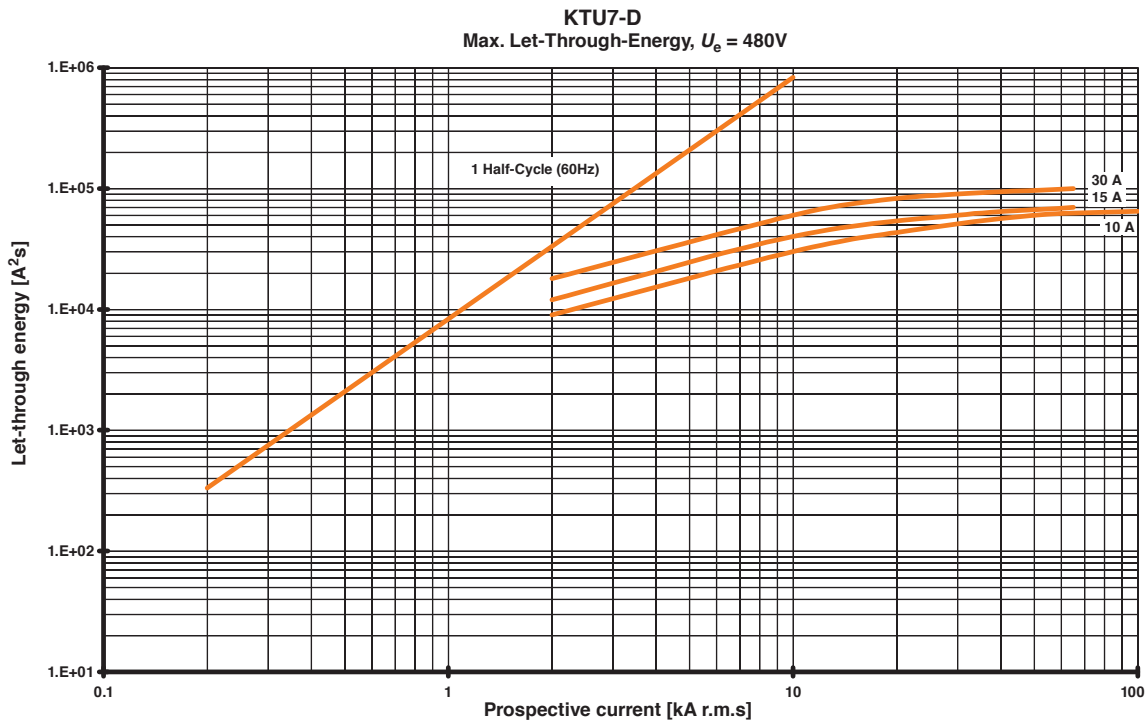

F

KTU7 Molded Case Circuit Breakers

KTU7-D Dimensions

Dimensions are in millimeters (inches). Dimensions not intended for manufacturing purposes.

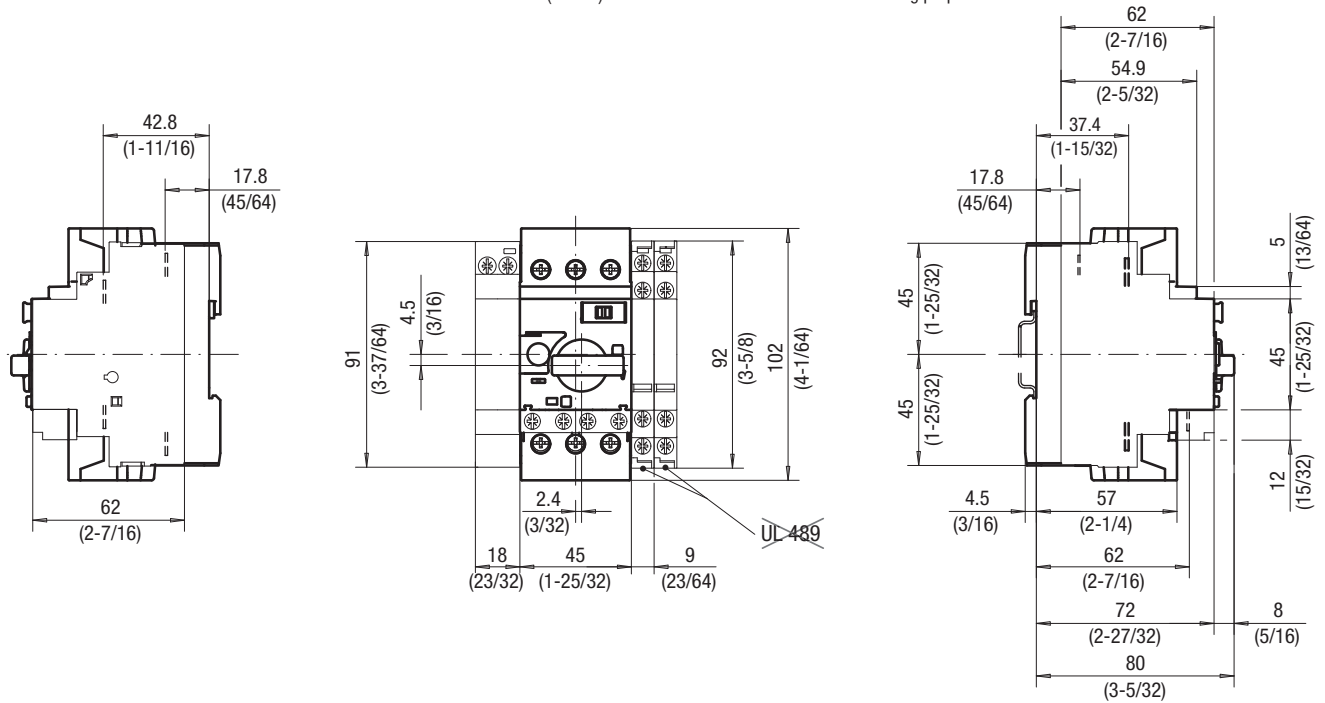

KTU7 Circuit Breaker Enclosure Requirements

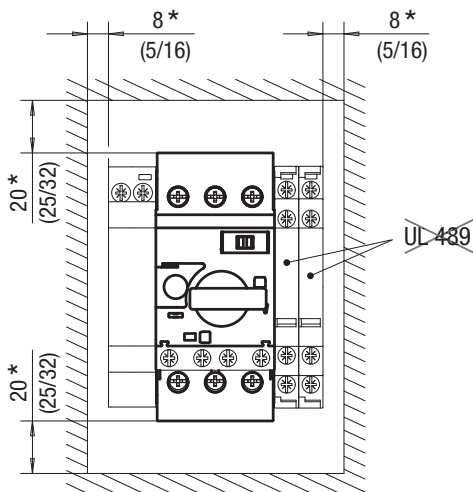

* - Minimum distance to grounded parts or walls

KTU7 Wiring Diagram

**3-Phase
KTU7-D-3**

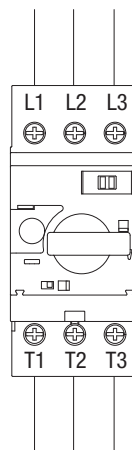

**2-Phase
KTU7-D-2**

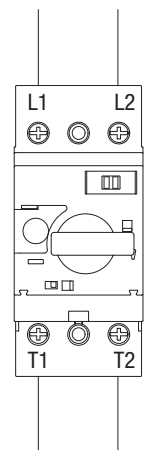

F
KTU7 Molded Case Circuit Breakers

F

KTU7 Molded Case Circuit Breakers

KTU7 with Busbar

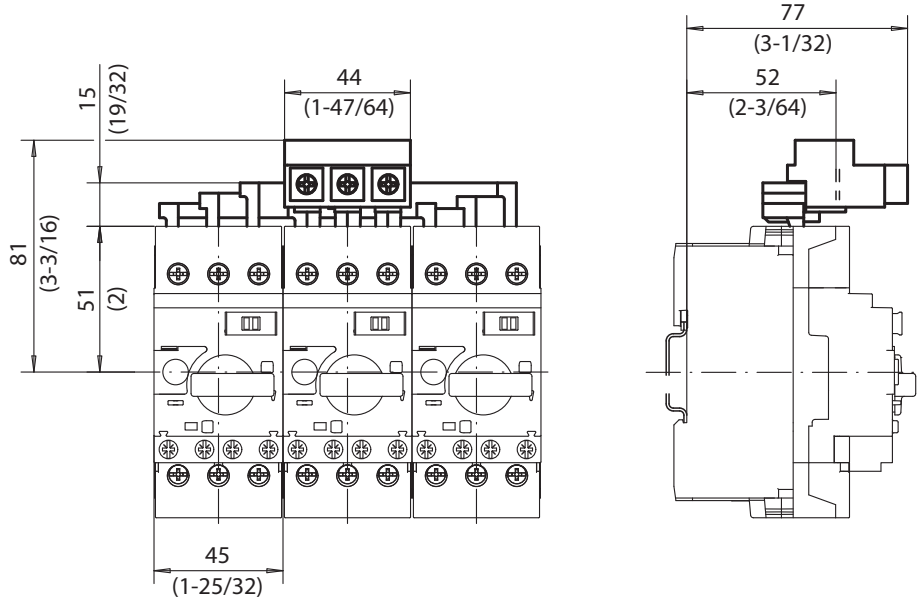

KTU7 with Screw Adaptor KT7-45-AS

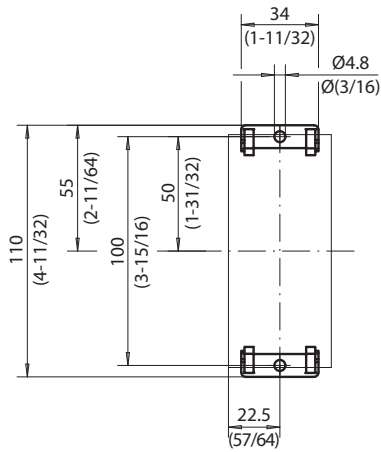

KTU7 Mounting Position

