

# GEFRAN

## Panel Mount "Hockey Puck" Relays and DIN Rail Mounted Solid State Relays up to 120 Amps



With over forty years of experience, Gefran is the world leader in the design and production of solutions for measuring, controlling, and driving industrial production processes. Gefran's know-how and experience guarantee continuity and tangible solutions. Gefran's line of solid state relays are the ideal solution for applications where high speed switching and long life are essential. In specific applications, solid state relays offer many advantages over electromechanical devices including no moving parts or contact arcing. In addition, solid state relays are directly compatible with logic components such as microprocessors and PLCs.

feature is important in certain medical, residential and industrial applications. The Gefran solid state relays also include built-in metal oxide varistor (MOV) protection to protect against internal damage to the solid state relay.

### Output Circuit Features

The Gefran solid state relays feature zero voltage turn-on, which means they are designed to turn on at the next zero crossover after application of the control voltage. This limits electromagnetic interference, reducing the chance of damage to downstream equipment. A built-in MOV reduces the likelihood of damage to the relay from rapid changes in voltage (dv/dt) and transient voltages.

### Many safety and convenience features

All Gefran solid state relays come standard with an LED to indicate when the relay is in an operational state. This increases safety and speeds troubleshooting.

In addition, all GQ hockey puck type relays come standard with a load side cover that provides touch protection. The GTS DIN-Rail mounted relays also offer touch protection through the use of a removable protective cover plate.

### Broad selection for many applications

The Gefran GQ solid state relays are available in single phase "hockey puck" models up to 90 amps and the GTS DIN-rail single phase units with integral heatsink up to 120 amps. The GTZ three phase models with integral heatsink up to 55 amps are also available.

### Opto-isolated input limits current leakage

All Gefran solid state relays feature opto-isolated inputs where an internal LED signals a photosensitive element when output switching is to occur. This provides up to 4,000V isolation between the input voltage and the output voltage and also limits current leakage. This

### Common Applications

- Heating controls
- Injection molding machines
- Semiconductor manufacturing equipment
- Glass processing
- Welding controls
- Food processing
- Industrial & commercial ovens
- Soldering machines
- Medical equipment
- Office machinery
- Robotics

### Integral heatsink with DIN-rail mounting

A complete selection of solid state relays are available with a built-in heatsink (GTS/GTZ models). This eliminates the hassle of selecting and installing a properly sized heatsink, or mounting to a panel mount relay directly on the back pan with silicone thermoconductive grease.

### Approvals

The Series GQ and GTZ solid state relays are cURus approved and CE marked. The GTZ DIN-rail solid state relays are cULus Listed and CE marked.

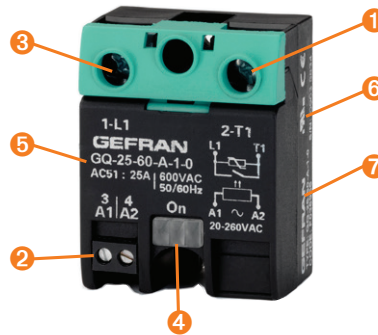

- ❶ Finger Safe Protection Covers
- ❷ AC or DC Input Connections
- ❸ AC Output Connection Models
- ❹ LED Status Indicator
- ❺ Internal MOV protection
- ❻ Integrated or optional heatsinks
- ❼ cURus, CE
- ❽ cULus, CE

### Catalog Number Quick Guide

**GQ- 15 - 24 - D - 1 - 4**

	Nominal Current	Nominal Voltage	Control Voltage	Overtoltage	Connectors
<b>Hockey Puck</b>	15 15A AC	24 230V AC	D 3...32V DC	1 Internal protection	4 Two-pin screw connector, low profile enclosed
<b>1-Phase</b>	25 25A AC	60 600V AC	A 20...260V AC		
<b>Panel Mount</b>	50 50A AC				
	90 90A AC				

**GTS- 25 / 60 - D - 0 -**

	Rated Current	Rated Voltage	Control Voltage	Alarm Output	Fan
<b>1-Phase</b>	15 15A AC	60 600V AC	D 6...32V DC	0 None	VEN-90 230V 14W
<b>DIN Rail mount</b>	25 25A AC		20...260V AC/DC		80x80x40
	40 40A AC				VEN-91 115V 14W
	50 50A AC				80x80x40
	60 60A AC				
	75 75A AC				Required on 120A models only
	90 90A AC				
	120 120A AC				

**GTZ 40 / 60 - D - 0 - VEN-91**

	Nominal Current	Nominal Voltage	Control Voltage	Alarm Output	Fan
<b>3-Phase</b>	25 25A AC	60 600V AC	DC	0 None	VEN-90 230V 14W
<b>DIN Rail mount</b>	40 40A AC		20...260V AC/DC		80x80x40
	55 55A AC				VEN-91 115V 14W
					80x80x40
					Required on 40A & 55A models only

**1 Pole Panel Mount Relay, 3-32V DC Control, 230V AC Output**  



Specifications	15 Amp		25 Amp		50 Amp		90 Amp	
	Catalog Number	Price	Catalog Number	Price	Catalog Number	Price	Catalog Number	Price
	GQ-15-24-D-1-4	<b>37.02</b>	GQ-25-24-D-1-4	<b>41.14</b>	GQ-50-24-D-1-4	<b>64.99</b>	GQ-90-24-D-1-4	<b>85.56</b>
<b>Input</b>	3 - 32V DC		3 - 32V DC		3 - 32V DC		3 - 32V DC	
Voltage Range	3 - 32V DC		3 - 32V DC		3 - 32V DC		3 - 32V DC	
Turn-on Voltage (min.)	≥ 2.7V DC		≥ 2.7V DC		≥ 2.7V DC		≥ 2.7V DC	
Turn-off Voltage (max.)	≤ 1V DC		≤ 1V DC		≤ 1V DC		≤ 1V DC	
Consumption	≤ 13mA @ 32V		≤ 13mA @ 32V		≤ 13mA @ 32V		≤ 13mA @ 32V	
Reverse Voltage	< 36V DC		< 36V DC		< 36V DC		< 36V DC	
<b>Output</b>	15		25		50		90	
Amp Rating AC51	15		25		50		90	
Nominal Voltage	24...230V AC		24...230V AC		24...230V AC		24...230V AC	
Maximum Voltage	20...253V AC		20...253V AC		20...253V AC		20...253V AC	
Zero Switching Voltage	≤ 20V		≤ 20V		≤ 20V		≤ 20V	
Frequency Range	45...65 Hz		45...65 Hz		45...65 Hz		45...65 Hz	
Dimension (mm)	58 (H) x 45 (W) x 30.5 (D), from base to top of control terminal 45 (D)							

**1 Pole Panel Mount Relay, 20-260V AC Control, 230V AC Output**  



Specifications	15 Amp		25 Amp		50 Amp		90 Amp	
	Catalog Number	Price	Catalog Number	Price	Catalog Number	Price	Catalog Number	Price
	GQ-15-24-A-1-4	<b>43.60</b>	GQ-25-24-A-1-4	<b>45.24</b>	GQ-50-24-A-1-4	<b>72.39</b>	GQ-90-24-A-1-4	<b>92.13</b>
<b>Input</b>	20...260V AC		20...260V AC		20...260V AC		20...260V AC	
Voltage Range	20...260V AC		20...260V AC		20...260V AC		20...260V AC	
Turn-on Voltage (min.)	≥ 15V AC		≥ 15V AC		≥ 15V AC		≥ 15V AC	
Turn-off Voltage (max.)	≤ 6V AC		≤ 6V AC		≤ 6V AC		≤ 6V AC	
Consumption	≤ 8mA @ 260V AC		≤ 8mA @ 260V AC		≤ 8mA @ 260V AC		≤ 8mA @ 260V AC	
<b>Output</b>	15		25		50		90	
Amp Rating AC51	15		25		50		90	
Nominal Voltage	24...230V AC		24...230V AC		24...230V AC		24...230V AC	
Maximum Voltage	20...253V AC		20...253V AC		20...253V AC		20...253V AC	
Zero Switching Voltage	≤ 20V		≤ 20V		≤ 20V		≤ 20V	
Frequency Range	45...65 Hz		45...65 Hz		45...65 Hz		45...65 Hz	
Dimension (mm)	58 (H) x 45 (W) x 30.5 (D), from base to top of control terminal 45 (D)							

**G** GEFAN Solid State Relays

#### 1 Pole Panel Mount Relay, 3-32V DC Control, 600V AC Output



Specifications	50 Amp		90 Amp	
	Catalog Number	Price	Catalog Number	Price
	GQ-50-60-D-1-4	<b>78.98</b>	GQ-90-60-D-1-4	<b>110.23</b>
<b>Input</b>	3 - 32V DC		3 - 32V DC	
Voltage Range	≥ 2.7V DC		≥ 2.7V DC	
Turn-on Voltage (min.)	≤ 1V DC		≤ 1V DC	
Turn-off Voltage (max.)	≤ 13mA @ 32V		≤ 13mA @ 32V	
Consumption	< 36V DC		< 36V DC	
Reverse Voltage	50		90	
<b>Output</b>	48...600V AC		48...600V AC	
Amp Rating AC51	40...660V AC		40...660V AC	
Nominal Voltage	≤ 40V		≤ 40V	
Maximum Voltage	45...65 Hz		45...65 Hz	
Zero Switching Voltage	58 (H) x 45 (W) x 30.5 (D), from base to top of control terminal 45 (D)			
Frequency Range				
Dimension (mm)				





#### 1 Pole Panel Mount Relay, 20-260V AC Control, 600V AC Output







Specifications	50 Amp		90 Amp	
	Catalog Number	Price	Catalog Number	Price
	GQ-50-60-A-1-4	<b>85.56</b>	GQ-90-60-A-1-4	<b>119.28</b>
<b>Input</b>	20...260V AC		20...260V AC	
Voltage Range	≥ 15V AC		≥ 15V AC	
Turn-on Voltage (min.)	≤ 6V AC		≤ 6V AC	
Turn-off Voltage (max.)	≤ 8mA @ 260V AC		≤ 8mA @ 260V AC	
Consumption	50		90	
<b>Output</b>	48...600V AC		48...600V AC	
Amp Rating AC51	40...660V AC		40...660V AC	
Nominal Voltage	≤ 40V		≤ 40V	
Maximum Voltage	45...65 Hz		45...65 Hz	
Zero Switching Voltage	58 (H) x 45 (W) x 30.5 (D), from base to top of control terminal 45 (D)			
Frequency Range				
Dimension (mm)				

**DISCONTINUED**

#### 1 Pole DIN-Rail Mount Relay, 6-32V DC Control, 600V AC Output



				
Specifications	15 Amp	25 Amp	40 Amp	50 Amp
	Catalog Number	Catalog Number	Catalog Number	Catalog Number
	GTS-15/60-D-0	GTS-25/60-D-0	GTS-40/60-D-0	GTS-50/60-D-0
<b>Input</b>				
Voltage Range	6 - 32V DC	6 - 32V DC	6 - 32V DC	6 - 32V DC
Turn-on Voltage (min.)	> 5.1V DC	> 5.1V DC	> 5.1V DC	> 5.1V DC
Turn-off Voltage (max.)	< 3V DC	< 3V DC	< 3V DC	< 3V DC
Consumption	≤ 10mA @ 32V	≤ 10mA @ 32V	≤ 10mA @ 32V	≤ 10mA @ 32V
Reverse Voltage	< 36V DC	< 36V DC	< 36V DC	< 36V DC
<b>Output</b>				
Amp Rating AC51	15	25	40	50
Nominal Voltage	24...600V AC	24...600V AC	24...600V AC	24...600V AC
Maximum Voltage	20...660V AC	20...660V AC	20...660V AC	20...660V AC
Zero Switching Voltage	< 20V	< 20V	< 20V	< 20V
Frequency Range	50/60 Hz	50/60 Hz	50/60 Hz	50/60 Hz
Dimension (mm)	100 (H) x 24 (W) x 107 (D)	108 (H) x 35 (W) x 142 (D)	108 (H) x 60 (W) x 142 (D)	108 (H) x 60 (W) x 142 (D)

#### 1 Pole DIN-Rail Mount Relay, 20-260V AC Control, 600V AC Output



				
Specifications	15 Amp	25 Amp	40 Amp	50 Amp
	Catalog Number	Catalog Number	Catalog Number	Catalog Number
	GTS-15/60-A-0	GTS-25/60-A-0	GTS-40/60-A-0	GTS-50/60-A-0
<b>Input</b>				
Voltage Range	20...260V AC/DC	20...260V AC/DC	20...260V AC/DC	20...260V AC/DC
Turn-on Voltage (min.)	≥ 15V AC/DC	≥ 15V AC/DC	≥ 15V AC/DC	≥ 15V AC/DC
Turn-off Voltage (max.)	≤ 6V AC/DC	≤ 6V AC/DC	≤ 6V AC/DC	≤ 6V AC/DC
Consumption	≤ 8mA @ 260V AC/DC	≤ 8mA @ 260V AC/DC	≤ 8mA @ 260V AC/DC	≤ 8mA @ 260V AC/DC
<b>Output</b>				
Amp Rating AC51	15	25	40	50
Nominal Voltage	24...600V AC	24...600V AC	24...600V AC	24...600V AC
Maximum Voltage	20...660V AC	20...660V AC	20...660V AC	20...660V AC
Zero Switching Voltage	< 20V	< 20V	< 20V	< 20V
Frequency Range	50/60 Hz	50/60 Hz	50/60 Hz	50/60 Hz
Dimension (mm)	100 (H) x 24 (W) x 107 (D)	108 (H) x 35 (W) x 142 (D)	108 (H) x 60 (W) x 142 (D)	108 (H) x 60 (W) x 142 (D)

**DISCONTINUED**

#### 1 Pole DIN-Rail Mount Relay, 6-32V DC Control, 600V AC Output

				
Specifications	60 Amp	75 Amp	90 Amp	120 Amp
	Catalog Number	Catalog Number	Catalog Number	Catalog Number
without integrate fan (not required)	GTS-60/60-D-0	GTS-75/60-D-0	GTS-90/60-D-0	
with integrated fan 230V				GTS-120/60-D-0-VEN-90
with integrated fan 115V				GTS-120/60-D-0-VEN-91
<b>Input</b>				
Voltage Range	6 - 32V DC	6 - 32V DC	6 - 32V DC	6 - 32V DC
Turn-on Voltage (min.)	> 5.1V DC	> 5.1V DC	> 5.1V DC	> 5.1V DC
Turn-off Voltage (max.)	< 3V DC	< 3V DC	< 3V DC	< 3V DC
Consumption	≤ 10mA @ 32V	≤ 10mA @ 32V	≤ 10mA @ 32V	≤ 10mA @ 32V
Reverse Voltage	< 36V DC	< 36V DC	< 36V DC	< 36V DC
<b>Output</b>				
Amp Rating @ 40°C	60	75	90	120
Nominal Voltage	24...600V AC	24...600V AC	24...600V AC	24...600V AC
Maximum Voltage	20...660V AC	20...660V AC	20...660V AC	20...660V AC
Zero Switching Voltage	< 20V	< 20V	< 20V	< 20V
Frequency Range	50/60 Hz	50/60 Hz	50/60 Hz	50/60 Hz
Dimension (mm)	108 (H) x 80 (W) x 107 (D)	108 (H) x 127 (W) x 142 (D)	108 (H) x 127 (W) x 142 (D)	108 (H) x 127 (W) x 158 (D)

#### 1 Pole DIN-Rail Mount Relay, 20-260V AC Control, 600V AC Output

				
Specifications	60 Amp	75 Amp	90 Amp	120 Amp
	Catalog Number	Catalog Number	Catalog Number	Catalog Number
without integrate fan (not required)	GTS-60/60-A-0	GTS-75/60-A-0	GTS-90/60-A-0	
with integrated fan 230V				GTS-120/60-A-0-VEN-90
with integrated fan 115V				GTS-120/60-A-0-VEN-91
<b>Input</b>				
Voltage Range	20...260V AC/DC	20...260V AC/DC	20...260V AC/DC	20...260V AC/DC
Turn-on Voltage (min.)	≥ 15V AC/DC	≥ 15V AC/DC	≥ 15V AC/DC	≥ 15V AC/DC
Turn-off Voltage (max.)	≤ 6V AC/DC	≤ 6V AC/DC	≤ 6V AC/DC	≤ 6V AC/DC
Consumption	≤ 8mA @ 260V AC/DC	≤ 8mA @ 260V AC/DC	≤ 8mA @ 260V AC/DC	≤ 8mA @ 260V AC/DC
<b>Output</b>				
Amp Rating @ 40°C	60	75	90	120
Nominal Voltage	24...600V AC	24...600V AC	24...600V AC	24...600V AC
Maximum Voltage	20...660V AC	20...660V AC	20...660V AC	20...660V AC
Zero Switching Voltage	< 20V	< 20V	< 20V	< 20V
Frequency Range	50/60 Hz	50/60 Hz	50/60 Hz	50/60 Hz
Dimension (mm)	108 (H) x 80 (W) x 107 (D)	108 (H) x 127 (W) x 142 (D)	108 (H) x 127 (W) x 142 (D)	108 (H) x 127 (W) x 158 (D)

GTS Relays are cUL (E243386)

#### 3 Pole DIN-Rail Mount Relay, 5-32V DC Control **DISCONTINUED**



Specifications		25 Amp	40 Amp	55 Amp
		Catalog Number	Catalog Number	Catalog Number
Without integrated fan (not required)		<b>GTZ25/60-D-0</b>		
with integrated fan 230V AC			<b>GTZ40/60-D-0-VEN-90</b>	<b>GTZ55/60-D-0-VEN-90</b>
with integrated fan 115V AC			<b>GTZ40/60-D-0-VEN-91</b>	<b>GTZ55/60-D-0-VEN-91</b>
<b>Input</b>	Voltage Range	5 - 32V DC	5 - 32V DC	5 - 32V DC
	Turn-on Voltage (min.)	> 4.5V DC	> 4.5V DC	> 4.5V DC
	Turn-off Voltage (max.)	≤ 3V DC	≤ 3V DC	≤ 3V DC
	Consumption	18 mA @ 5V DC - 22mA @ 32V DC	18 mA @ 5V DC - 22mA @ 32V DC	18 mA @ 5V DC - 22mA @ 32V DC
<b>Output</b>	Reverse Voltage	< 36V DC	< 36V DC	< 36V DC
	Amp Rating AC51	25	40	55
	Nominal Voltage	24...600V AC	24...600V AC	24...600V AC
	Maximum Voltage	24...660V AC	24...660V AC	24...660V AC
	Zero Switching Voltage	< 20V	< 20V	< 20V
	Frequency Range	50/60 Hz	50/60 Hz	50/60 Hz
Dimension (mm)		100 (H) x 24 (W) x 107 (D)	108 (H) x 35 (W) x 142 (D)	108 (H) x 60 (W) x 142 (D)





#### 3 Pole DIN-Rail Mount Relay, 20...260V AC Control, 600V AC Output

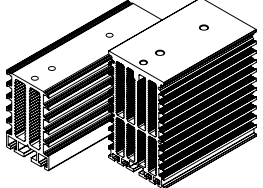
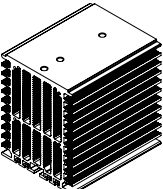
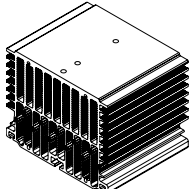

Specifications		25 Amp	40 Amp	55 Amp
		Catalog Number	Catalog Number	Catalog Number
Without integrated fan (not required)		<b>GTZ25/60-A-0</b>		
with integrated fan 230V AC			<b>GTZ40/60-A-0-VEN-90</b>	<b>GTZ55/60-A-0-VEN-90</b>
with integrated fan 115V AC			<b>GTZ40/60-A-0-VEN-91</b>	<b>GTZ55/60-A-0-VEN-91</b>
<b>Input</b>	Voltage Range	20...260V AC/DC	20...260V AC/DC	20...260V AC/DC
	Turn-on Voltage (min.)	≥ 15V AC/DC	≥ 15V AC/DC	≥ 15V AC/DC
	Turn-off Voltage (max.)	≤ 6V AC/DC	≤ 6V AC/DC	≤ 6V AC/DC
	Consumption	≤ 8mA @ 260V AC/DC	≤ 8mA @ 260V AC/DC	≤ 8mA @ 260V AC/DC
<b>Output</b>	Amp Rating @ 40°C	25	40	55
	Nominal Voltage	24...600V AC	24...600V AC	24...600V AC
	Maximum Voltage	24...660V AC	24...660V AC	24...660V AC
	Zero Switching Voltage	< 20V	< 20V	< 20V
	Frequency Range	50/60 Hz	50/60 Hz	50/60 Hz
	Dimension (mm)		100 (H) x 24 (W) x 107 (D)	108 (H) x 35 (W) x 142 (D)

GTZ Relays are cUR (E243386). Not CSA.

**Accessories**

Heatsinks	Description	Catalog Number	Price
 <p>DIS-25GD      DIS-50G</p>	<p><b>Heatsink –</b> Extruded aluminum DIN-rail mount for mounting one GQ relay. Includes PAN-1 kit attachment for panel mounting.</p> <ul style="list-style-type: none"> <li>- For use with GQ 15A &amp; 25A relays</li> <li>- 100 x 24 x 65mm</li> <li>- Thermal Resistance Rth &gt; 2.8 K/W</li> </ul>	<b>DIS-25GD</b>	<b>79.80</b>
	<ul style="list-style-type: none"> <li>- For use with GQ 25A &amp; 50A relays</li> <li>- 100 x 60 x 100mm</li> <li>- Thermal Resistance Rth &gt; 8.3 K/W</li> </ul>	<b>DIS-50G</b>	<b>79.80</b>
	<p><b>Heatsink –</b> Extruded aluminum DIN-rail mount for mounting one GQ relay. Includes PAN-1 kit attachment for panel mounting.</p> <ul style="list-style-type: none"> <li>- For use with GQ 50A relays</li> <li>- 100 x 80 x 100mm</li> <li>- Thermal Resistance Rth &gt; 0.66 K/W</li> </ul>	<b>DIS-60G</b>	<b>94.60</b>
	<p><b>Heatsink –</b> Extruded aluminum DIN-rail mount for mounting one GQ relay. Includes PAN-1 kit attachment for panel mounting.</p> <ul style="list-style-type: none"> <li>- For use with GQ 90A relays</li> <li>- 100 x 126 x 100mm</li> <li>- Thermal Resistance Rth &gt; 0.56 K/W</li> </ul>	<b>DIS-90G</b>	<b>119.28</b>
	<p><b>Kit Attachment –</b> Allows for panel mounting the GTS Series and DIS heat sinks. Includes 2 plastic supports, 2 screws, and 2 washers.</p>	<b>PAN-1</b>	<b>15.63</b>
	<p><b>Silicone thermoconductive paste –</b> for coupling the GQ Relay power module to the heat sink. 100 g tube.</p>	<b>SIL-1</b>	<b>67.45</b>
	<p><b>Graphite Film –</b> 35 x 55 mm graphite film for GQ relays.</p> <ul style="list-style-type: none"> <li>- 0.12 mm thick, 2.1 W (m*K).</li> <li>- 200 x 240 mm sheet with 25 adhesives</li> </ul>	<b>SIL-GQ</b>	<b>64.99</b>

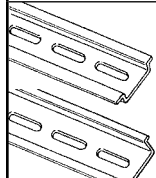
Accessory	Description	Catalog Number	Price
	<p><b>DIN-rail - 2 meter lengths (6'6")</b> Top Hat, low profile (price per rail) Top Hat, high profile (package of 20, price per rail)</p>	<b>3F</b> <b>3AF</b>	<b>See page N30</b>



**Cross Reference Series SAR/SAS to Gefran Solid State Relays**

Sprecher+ Schuh Catalog Number	Gefran Catalog Number	Gefran Product Status
<b>SAR Series DIN-Rail Mount</b>		
SAR6-25-1D	GTS-25/60-D-0	
SAR6-25-1	GTS-25/60-A-0	
SAR6-40-1D	GTS-40/60-D-0	
SAR6-40-1	GTS-40/60-A-0	
SAR6-50-1D	GTS-50/60-D-0	
SAR6-50-1	GTS-50/60-A-0	
SAR6-75-1D	GTS-75/60-D-0	
SAR6-75-1	GTS-75/60-A-0	
SAR6-100-1D	GTS-90/60-D-0	Select GTS-120/60-D... For above 90A+
SAR6-100-1	GTS-90/60-A-0	Select GTS-120/60-A... For above 90A+
~	GTS-120/60-D-0-VEN*	New 120A offering
~	GTS-120/60-A-0-VEN*	New 120A offering
SAR6-30-3D	GTZ25/60-D-0	Select GTZ40/60-D-0-VEN* for above 25A+
SAR6-30-3	GTZ25/60-A-0	Select GTZ40/60-A-0-VEN* for above 25A+
~	GTZ40/60-D-0-VEN*	New 40A offering
~	GTZ40/60-A-0-VEN*	New 40A offering
~	GTZ55/60-D-0-VEN*	New 55A offering
~	GTZ55/60-A-0-VEN*	New 55A offering
<b>SAS Series Panel Mount</b>		
SAS3-10-1D	GQ-15-24-D-1-4	
SAS3-10-1	GQ-15-24-A-1-4	
SAS3-25-1D	GQ-25-24-D-1-4	
SAS3-25-1	GQ-25-24-A-1-4	
SAS3-50-1D	GQ-50-24-D-1-4	
SAS3-50-1	GQ-50-24-A-1-4	
SAS3-75-1D	GQ-90-24-D-1-4	
SAS3-75-1	GQ-90-24-A-1-4	
SAS6-50-1D	GQ-50-60-D-1-4	
SAS6-50-1	GQ-50-60-A-1-4	
SAS6-75-1D	GQ-90-60-D-1-4	
SAS6-75-1	GQ-90-60-A-1-4	

\* Suffix code for selected fan voltage

**General Application Notes**

**Heatsinks**

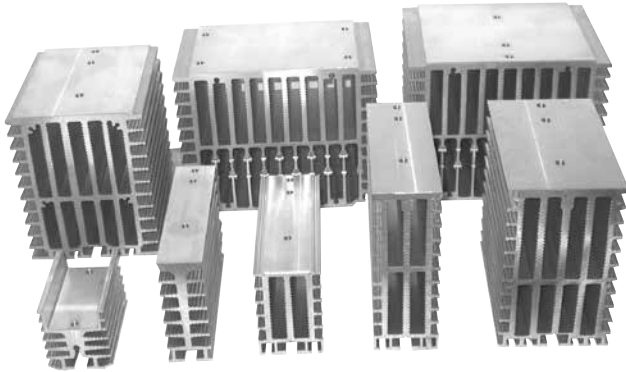

Different models of heatsinks have been designed and tested to meet size and dimension needs.

**How to choose a heatsink**

- Set max. air temperature inside the panelboard ( $T_{max_a}$ )
- Set max. operating current:  $I_{max} = I_{nom. load} + 10\%$
- Draw on the “graphs”  $T_{max_a}$ ,  $I_{max}$  points.
- Choose the smallest heatsink (starting from upwards), which point [ $T_{max_a}$ ,  $I_{max}$ ] is in the gray working area of dissipation curves
- Respect installation distances

**Installation**

In order to obtain best reliability, it is important to install a heatsink correctly inside the panel, to reach an adequate thermal exchange between the device and the surrounding air in natural convection conditions.

**How to install it correctly:**

Mount it vertically ( max. 10° inclination from the vertical axis)

- Vertical distance between a heatsink and the panel wall: 100 mm at least.
- Horizontal distance between a heatsink and the panel wall: 20 mm at least.
- Vertical distance between two heatsinks: 300 mm at least.
- Horizontal distance between two heatsinks: 40 mm at least.

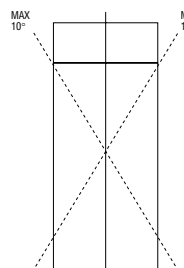

Check that cable channels do not reduce these distances; should it happen, mount the relays overhanging from the panel, so that the air can flow vertically on the heatsink without obstacles (see Fig.1).

**Fig. 1**

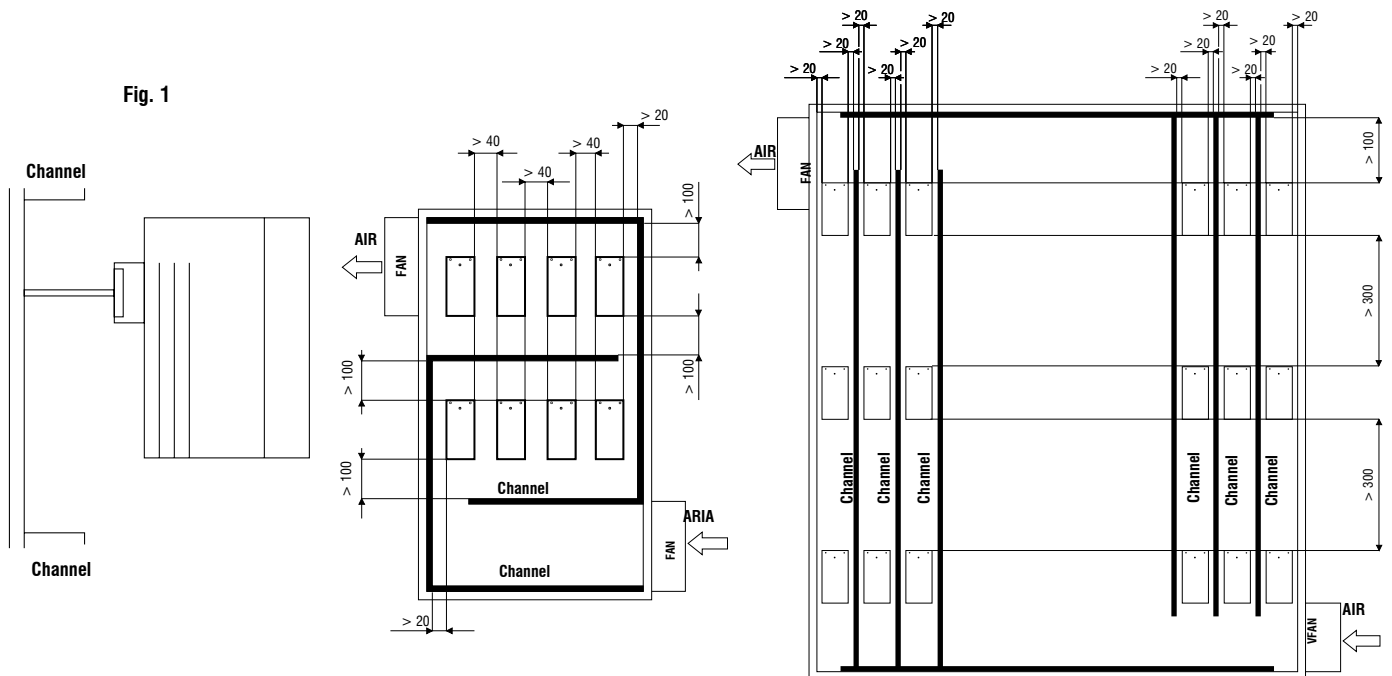

**G**  
**Gefran Solid State Relays**

**General Application Notes** *(continued)*

**Dissipation Curves**

Effective current controllable based on room temperature

**G**  
**Gefran Solid State Relays**

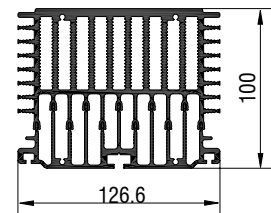
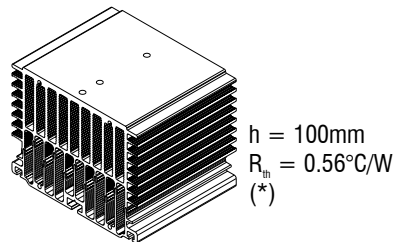
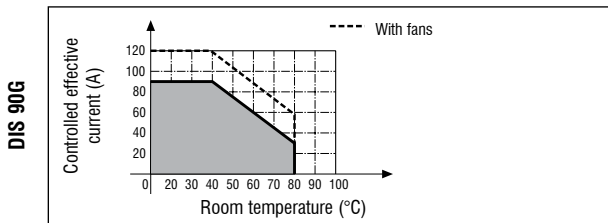
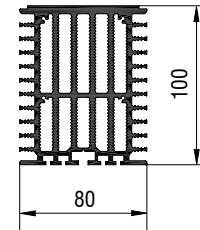
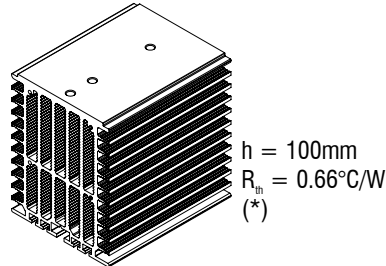
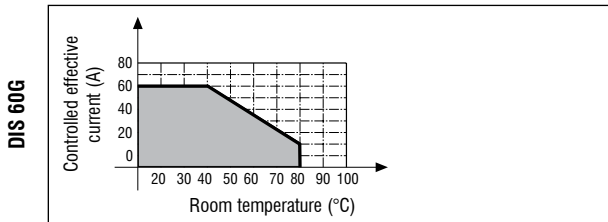
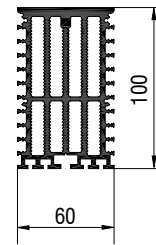
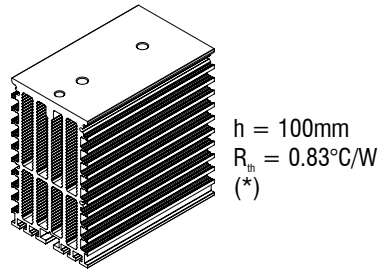
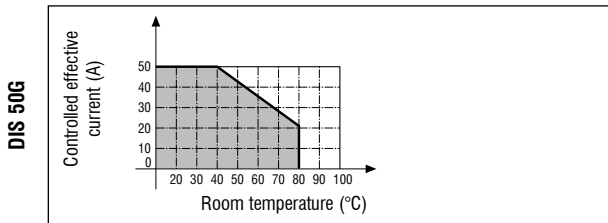
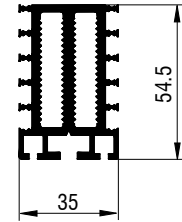
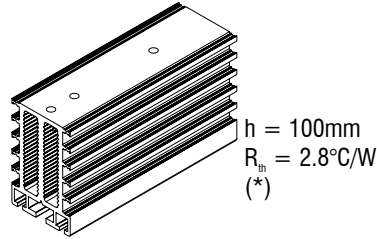
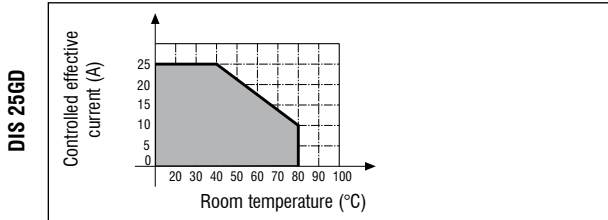

**General Application Notes (continued)**

**Varistors (MOV)**

If your application is located near inductive loads, or shares power sources with large inductive loads that are creating transients in excess of the blocking voltage of the Gefran solid state relay, then you must install a metal oxide varistor (MOV) to protect the solid state relay. It is up to the installation company to properly size the MOV to the application! Ideally, the MOV protection is near the noise generating inductive load (such as a motor, drive, or other large inductive coil) or you can place MOVs directly across the output terminals of the SSR.



**Recommended MOVs from EPCOS:**

Part Number	Working Voltage (V)
S20K300	120-290 V AC
S20K420	291-400 V AC
S20K510	401-500 V AC

The Gefran solid state relays include technology that dramatically reduces your need to install an external MOV except in extremely noisy environments or inductive load applications.

**Fuses and Fuse Holders**

These fuses ensure the maximum safety in solid state relay applications. Fuses with a very high cutoff power are used for this kind of applications. See Table 1.



**Table 1.**

Recommended Fuses (by others) for GQ, GTS & GTZ Relays					
Type relay	i <sup>2</sup> t	Nominal voltage	Size	Dimensions (mm)	Bussman Part No.
GQ 15A	450	230 480	16A	10x38	FWC16A10F
GTS 25A GQ 25A	645 450	230 480 600	25A	10x38	FWC25A10F
GTS 40A	1010	230 480	40A	14x51	FWP40A14
GTS 50A GQ 50A	6600	230 480 600	63A	22x58	FWP63A22F
GTS 60A	6600	230 480 600	80A	22x58	FWP80A22F
GTS 75A	8000	230 480	80A	22x58	FWP80A22F
GTS 90A GQ 90A	11200	230 480 600	100A	22x58	FWP100A22F
GTS 120A	11200	230 480 600	125A	0-0-0-TN/80 100x51x30	170M1418000-TN/80
GTZ 25A	450 645	400 480	25A	12x32	FWC25A10F
GTZ 40A	1010	480 600	40A	14x51	FWP40A14
GTZ 55A	6600	480 600	63A	22x58	FWP63A22F

(\*) PF for fuseholders: LEGRAND, PFI for fuseholders: ITALWEBER

**G**  
Gefran Solid State Relays

**General Application Notes** (continued)

**Series GQ Installation notes**

- The heat sink must be grounded.
- Power controllers are designed to assure a switching function that does not include protection of the load line or of devices connected to it. The customer must provide all necessary safety and protection devices in conformity to current electrical standards and regulations.
- Protect the solid state relay by using an appropriate heat sink (accessory). The heat sink must be sized according to room temperature and load current.

**Dissipated Power Calculation**

Single-phase relay

$$Pd \text{ GQ..15/25} = 1.45 * IRMS \text{ [W]}$$

$$Pd \text{ GQ..50/90} = 1.35 * IRMS \text{ [W]}$$

IRMS = single-phase load current

**Heatsink Thermal Resistance Calculation**

$$R_{th} = (90^{\circ}\text{C} - \text{max amb. T}) / Pd$$

- where Pd = dissipated power
- Max. amb. T = max air temperature inside the electrical cabinet.

Use a heatsink with thermal resistance inferior to the calculated one (Rth).

Maximum surrounding air temperature 40°C suitable for use in pollution degree 2 or better.

**Procedure for mounting on heat sink:**

The module-heat sink contact surface must have a maximum planarity error of 0.05mm. and maximum roughness of 0.02mm. The fastening holes on the heat sink must be threaded and countersunk.

Attention: spread 1 gram of thermoconductive silicone (we recommend DOW CORNING 340 HeatSink) on the dissipative metal surface of the module. The surfaces must be clean and there must be no impurities in the thermoconductive paste. As alternative it is also possible to use the graphite film SIL-GQ available as accessory.

- Alternately tighten the two fastening screws until reaching a torque of 0.4...0.6 Nm. Wait 5 minutes for any excess paste to drain.
- Alternately tighten the two fastening screws until reaching a torque of 1.2...1.4 Nm.

**Installation on heatsink:**

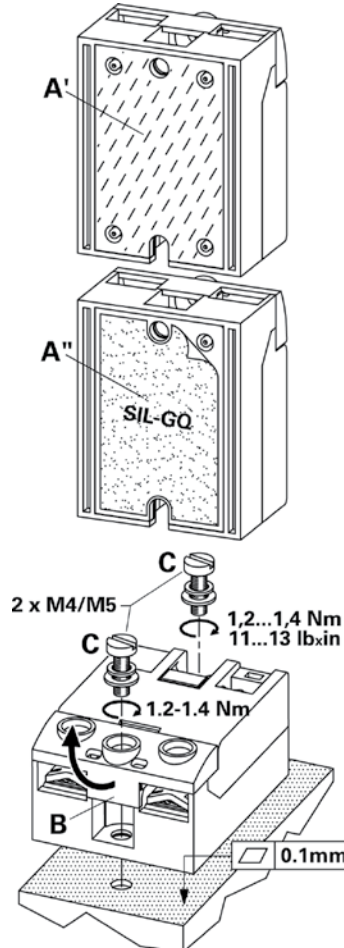

**General Application Notes (continued)**

**Series GTS Installation notes**

Power controllers are designed to assure a switching function that does not include protection of the load line or of devices connected to it. The customer must provide all necessary safety and protection devices in conformity to current electrical standards and regulations.

To assure maximum reliability, it is essential to install the unit correctly in the panel in order to guarantee adequate heat exchange between the heat sink and the room under natural convection conditions.

Maximum surrounding air temperature 40°C “Open Type Equipment” suitable for use in pollution degree 2 or better.

Install the unit vertically (max 10° inclination from vertical axis).

- Vertical distance between unit and panel wall >100 mm
- Horizontal distance between unit and panel wall at least 20 mm
- Vertical distance between one unit and the next at least 300 mm
- Horizontal distance between one unit and the next at least 20 mm

Make sure that the wire raceways do not reduce such distances. If they do, install the units cantilevered to the panel so that air can flow vertically onto the heat sink without obstruction.

**Equipment should be short circuit protected by semiconductor fuse type:**

Model	Fuse manufacturer	Fuse Model size
GTS 15/230	Bussmann Div Cooper (UK) Ltd	FWC16A10F 10x38
GTS 25/60		FWC25A10F 10x38
GTS 40/230, GTS 40/60		FWP40A14F 14x51
GTS 50/230, GTS 50/60		FWP63A22F 22x58
GTS 60/230, GTS 60/60, GTS 75/230, GTS 75/60		FWP80A22F 22x58
GTS 90/230, GTS 90/60		FWP100A22F 22x58
GTS 120/230, GTS 120/60	Bussmann Intn'l Inc. USA	170M1418 000- TN/80

**Series GTZ Installation notes**

Power controllers are designed to assure a switching function that does not include protection of the load line or of devices connected to it. The customer must provide all necessary safety and protection devices in conformity to current electrical standards and regulations.

To assure maximum reliability, it is essential to install the unit correctly in the panel in order to guarantee adequate heat exchange between the heat sink and the room under natural convection conditions.

Install the unit vertically (max 10° inclination from vertical axis).

- Vertical distance between a heatsink and panel wall >100 mm
- Horizontal distance between a heatsink and panel wall at least 20 mm
- Vertical distance between two heatsink at least 300 mm
- Horizontal distance between two heatsink at least 20 mm

Make sure that the cable raceways do not reduce such distances. If they do, install the GTZ overhanging from the panel, so that the air can flow vertically on the heatsink without obstruction.

**Warnings**



During continuous operation, the heat sink can reach very high temperatures, and keeps a high temperature even after the unit is turned off due to its high thermic inertia.



DO NOT work on the power section without first cutting out electrical power to the panel.



Follow the instructions in the technical manual.

**Technical Information**

			<b>GQ-15-24-...</b>	<b>GQ-25-24-...</b>	<b>GQ-50-24-...</b>	<b>GQ-90-24-...</b>	<b>GQ-50-60-...</b>	<b>GQ-90-60-...</b>
<b>Amp Rating</b>	AC51	[A rms]	15	25	50	90	50	90
	AC53	[A rms]	3	5	15	20	15	20
Min. load current		[A rms]	0.1	0.3	0.3	0.5	0.3	0.5
Repetitive overcurrent (t = 1s)		[A rms]	≤ 35	≤ 60	≤ 125	≤ 150	≤ 125	≤ 150
Non-repetitive overcurrent (t = 20 s)		[A p]	200	300	600	1500	600	1500
Current drop at nominal voltage and frequencies		[mA rms]	≤ 8	≤ 8	≤ 8	≤ 10	≤ 8	≤ 10
I <sup>2</sup> t for fusing (t = 1-10 ms)		[A <sup>2</sup> s]	≤ 200	≤ 450	≤ 1,800	≤ 11,200	≤ 1,800	≤ 11,200
Critical di/dt		[A/μs]	≥ 100	≥ 100	≥ 100	≥ 100	≥ 100	≥ 100
Voltage drop at nominal current		[V rms]	≤ 1.45	≤ 1.45	≤ 1.35	≤ 1.35	≤ 1.35	≤ 1.35
Critical dv/dt off state		[V/μs]	≥ 1000	≥ 1000	≥ 1000	≥ 1000	≥ 1000	≥ 1000
I <sub>th</sub>		[A]	15	25	50	90	50	90

**Input**

**DC Control**

Voltage Range	3 - 32V DC
Turn-on Voltage (min.)	≥ 2.7V DC
Turn-off Voltage (max.)	≤ 1V DC
Consumption	≤ 13mA @ 32V
Reverse Voltage	< 36V DC

**AC Control**

Voltage Range	20...260V AC/V DC
Turn-on Voltage (min.)	≥ 15V AC/V DC
Turn-off Voltage (max.)	≤ 6V AC/V DC
Consumption	≤ 8mA ac/cc @ 260V AC/V DC

**Output**

Nominal Voltage	24...230V AC	48...600V AC
Maximum Voltage	20...253V AC	40...660V AC
Non-repetitive Voltage	600Vp	1200Vp
Zero Switching Voltage	≤ 20V	≤ 40V
Frequency Range	45...65 Hz	45...65 Hz

**Insulation**

Nominal voltage	input/output	[V ac]	≥ 4000
	output/case	[V ac]	≥ 2500
Resistance	input/output	[Ω]	≥ 10 <sup>10</sup>
	output/case	[Ω]	≥ 10 <sup>10</sup>
Capacity	input/output	[pF]	≤ 8
	output/case	[pF]	≤ 100

**Ambient Conditions**

Ambient temperature	-25...+80°C [-13...176°F]
Storage temperature	-55...+100°C [-67...212°F]
Maximum relative humidity	50% at 40°C
Maximum installation altitude	2000 m above sea level
Pollution level	3

**Thermal Features**

Junction temperature	≤ 125°C [257°F]							
R <sub>th</sub>	junction/ambient	[K/W]	≤ 12	≤ 12	≤ 12	≤ 12	≤ 12	≤ 12
	junction/case	[K/W]	≤ 1.25	≤ 1.25	≤ 0.65	≤ 0.30	≤ 0.65	≤ 0.30

Heatsink R<sub>th</sub> = (90°C - max amb. T / Pd)

Where Pd = dissipated power

Max. amb. T = max. air temperature inside the electrical cabinet

Use a heatsink with thermal resistance less than the calculated R<sub>th</sub> value

#### Terminals and Leads

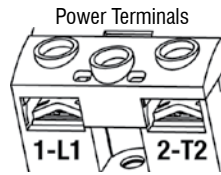

Command Terminals

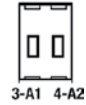

Terminal Type

Screw (m4) contact area (LxP) 13 x 11 mm

screw M2.5 MORS4 (22...16 AWG)

1(L1) 2(T1)		3(A1) 4(A2)		
	1x 2,5...6 mm <sup>2</sup> 1x 14...10 AWG 2x 1,5...2,5 mm <sup>2</sup> 2x 16...14 AWG 2x 2,5...6 mm <sup>2</sup> 2x 14...10 AWG		1x 0,2...2,5 mm <sup>2</sup> 1x 24...14 AWG 2x 0,2...1,5 mm <sup>2</sup> 2x 24...16 AWG	
	1x 1,5...6 mm <sup>2</sup> 1x 16...10 AWG 2x 1,5...6 mm <sup>2</sup> 2x 16...10 AWG		1x 0,25...2,5 mm <sup>2</sup> 1x 23...14 AWG 2x 0,25...1 mm <sup>2</sup> 2x 23...18 AWG	
	1x 2,5...25 mm <sup>2</sup> 1x 14...4 AWG			
	2...2,4 Nm 18...21 lbxin			
	GQ..15.. 2,5 mm <sup>2</sup> 14 AWG	GQ..25.. 6 mm <sup>2</sup> 10 AWG	GQ..50.. 12 mm <sup>2</sup> (2x6) 7 AWG (2x10)	GQ..90.. 25 mm <sup>2</sup> 4 AWG

#### Recommended Fuses (by others)

HIGH SPEED FUSES			
Model	Size I <sup>2</sup> T	Bussman Part No.	Dissipated power @ I <sub>n</sub>
GQ15...	16A 150A <sup>2</sup> S	FWC16A10F 338470	3,5W
GQ25...	25A 390A <sup>2</sup> S	FWC25A10F 338474	6W
	375A <sup>2</sup> S	FWC25A14F 338130	7W
GQ50...	50A 1800A <sup>2</sup> S	FWC50A14F 338079	9W
	50A 1600A <sup>2</sup> S	FWC50A22F 338127	9,5W
GQ90...	80A 6600A <sup>2</sup> S	FWP80A22F 338199	14W
	100A 12500A <sup>2</sup> S	FWP100A22F 338478	16W



**Heatsink / Thermal Resistance**

Model	Gefran Heatsink (see accessories)	Thermal Resistance
GQ15... GQ25...	DIS 25GD DIS 50G	$R_{th} \geq 2,8 \text{ K/W}$ $R_{th} \geq 0,83 \text{ K/W}$
GQ50...	DIS 50G	$R_{th} \geq 0,83 \text{ K/W}$
GQ90...	DIS 90G	$R_{th} \geq 0,56 \text{ K/W}$

Data relating to 40°C ambient temperature, heatsink in vertical position with 15 cm of free air above and below.

**Section Cable**

Model	Section
GQ15...	2.5mm <sup>2</sup> / 14 AWG
GQ25...	6mm <sup>2</sup> / 10 AWG
GQ50...	12mm <sup>2</sup> / 7 AWG
GQ90...	25mm <sup>2</sup> / 4 AWG

Minimum allowed rated section based on the rated currents of the power solid state relays, for copper leads isolated in PVC in continuous use and at room temperature of 40°C, according to standards CEI 44-5, CEI 17-11, IEC 408 pursuant to standard EN60204-1.  
Power terminals in compliance with standard EN60947-1

**EMC Emission**

EN 61000-6-4	Emissions conducted at radiofrequency	Class A (Industrial devices)
EN 61000-6-4	Emissions irradiated at radiofrequency	Class A (Industrial devices)

The product is designed for type A environments. Use of the product in type B environments may cause undesired electromagnetic noise. In this case, the user should take appropriate steps for improvement.

**EMC Immunity**

EN 61000-6-2	Immunity for industrial environments	
EN 61000-4-2	Electrostatic discharges 4kV by contact; 8 kV in air.	Performance criterion 2
EN 61000-4-6	Electromagnetic field at radiofrequency Test level 3. 0.15-80MHz	Performance criterion 1
EN 61000-4-3	Electromagnetic field at radiofrequency Test level 10V/m. 80-1000MHz	Performance criterion 1
EN 61000-4-4	Immunity to burst	Test level 2kV/100 KHz. Performance criterion 2
EN 61000-4-5	Immunity to surge	Test level: 2kV (Phase-ground); 1kV (Phase-phase). Performance criterion 2

**Safety**

EN 61010-1	Safety requirements
------------	---------------------

### Technical Information

Amp Rating		GTS-15	GTS-25	GTS-40	GTS-50	GTS-60	GTS-75	GTS-90	GTS-120
Rated Current @ 40°C (continuous service)	[A rms]	15	25	40	50	60	75	90	120
Non-repetitive overcurrent (t = 20 ms)	[A]	400	400	600	1150	1150	1300	1500	1500
I <sup>2</sup> t for blowout	[A <sup>2</sup> s]	≤ 450	≤ 645	≤ 1010	≤ 6600	≤ 6600	≤ 8000	≤ 11,200	≤ 11,200
dV/dt critical with output deactivated	[V/μs]	1000	1000	1000	1000	1000	1000	1000	1000

Input		
DC Control	Voltage Range	6 - 32V DC
	Turn-on Voltage (min.)	> 5.1V DC
	Turn-off Voltage (max.)	< 3V DC
	Consumption	≤ 10mA @ 32V
	Reverse Voltage	< 36V DC
AC Control	Voltage Range	20...260V AC/DC
	Turn-on Voltage (min.)	≥ 15V AC/DC
	Turn-off Voltage (max.)	≤ 6V AC/DC
	Consumption	≤ 8mA @ 260V AC/DC

Output		
	Nominal Voltage	24...600V AC
	Maximum Voltage	20...660V AC
	Non-repetitive Voltage	500Vp for 230V models, 1200Vp for 480V models
	Zero Switching Voltage	< 20V
	Frequency Range	50/60 Hz

Isolation		
Rated voltage	input/output	[V ac] ≥ 4000

Ambient Conditions		
Ambient temperature		0°...+80°C [32°...+176°F] according to dissipation curves
Storage temperature		-20...+85°C [-4°...+185°F]
Maximum relative humidity		50% at 40°C
Maximum installation altitude		2000m above sea level
Pollution level		3

### Dissipation Curves

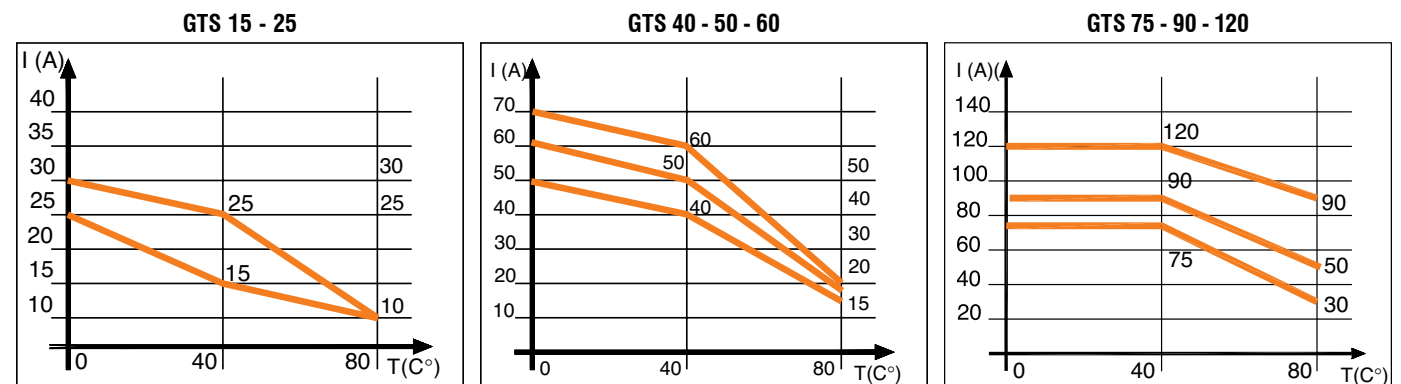

N.B.: Curves for the GTS 120 refer to the device complete with standard running.

### Technical Information

#### Terminal and Conductors

Size	Terminal	Contact area (WxD) screw type	Type of preisolated terminal ②	Max section. ① conductor tightening torque
15/20A	C	6.4x9 M3	1, 2, 4	6mm <sup>2</sup> / 10AWG 0.6Nm max
	P	6.4x9 M3	1, 2, 4	6mm <sup>2</sup> / 10AWG 0.4 - 0.6Nm
	G	9x12 M5	1	6mm <sup>2</sup> / 10AWG 1.3 - 1.8Nm
25A	C	6.4x9 M3	1, 2, 4	6mm <sup>2</sup> / 10AWG 0.6Nm max
	P	6.4x9 M3	1, 2	6mm <sup>2</sup> / 10AWG 0.4 - 0.6Nm
	G	9x12 M5	1	6mm <sup>2</sup> / 10AWG 1.3 - 1.8Nm
40A	C	6.3x9 M3	1, 2, 3	2.5mm <sup>2</sup> / 14AWG 0.6Nm max
	P	12x12 M5	1, 2	16mm <sup>2</sup> / 6AWG 1.5 - 2.2Nm
	G	11.5x12 M5	1	16mm <sup>2</sup> / 6AWG 1.5 - 2.2Nm
50/60A	C	6.3x9 M3	1, 2, 3	2.5mm <sup>2</sup> / 14AWG 0.6Nm max
	P	16x18 M6	1, 2	50mm <sup>2</sup> / 0AWG 3.5 - 6Nm
	G	14x16 M5	1	50mm <sup>2</sup> / 0AWG 1.8 - 2.5Nm
75-90A	C	6.3x9 M3	1, 2, 3	2.5mm <sup>2</sup> / 14AWG 0.6Nm max
	P	16x18 M6	1, 2	50mm <sup>2</sup> / 0AWG 3.5 - 6Nm
	G	14x16 M5	1	50mm <sup>2</sup> / 0AWG 1.8 - 2.5Nm
120A	C	6.3x9 M3	1, 2, 3	2.5mm <sup>2</sup> / 14AWG 0.6Nm max
	P	16x18 M6	1, 2	50mm <sup>2</sup> / 0AWG 3.5 - 6Nm
	G	14x16 M5	1	50mm <sup>2</sup> / 0AWG 1.8 - 2.5Nm

Terminal: C = Control, P = Power, G = Ground

#### Terminal Types



1. Eyelet



2. Fork



3. Tip



4. Faston

- ① The max. sections specified refer to unipolar copper wires isolated in PVC..
- ② The screw terminals must be suitable for field wiring connection only when the wire is provided with eyelet tube terminal type 1.

### Technical Information

Amp Rating		GTZ-25/60	GTZ-40/60	GTZ-55/60	GTZ-40/60	GTZ-55/60
Category AC51, AC53a	[A rms]	25	40	55	40	55
Nominal current (I <sub>max</sub> )	[A rms]	3x25	3x40	3x55	3x40	3x55
Non-repetitive overcurrent (t = 20 ms)	[A]	400	600	1150	600	1150
I <sup>2</sup> t for blowout	[A <sup>2</sup> s]	645	1010	6600	1010	6600
<b>DC Control Input</b>	Voltage Command Circuit (U <sub>c</sub> )	5...32V DC				
	Turn-on Voltage (min.)	> 4.5V DC				
	Turn-off Voltage (max.)	< 3V DC				
	Consumption	≤ 18mA @ 5V DC - 22mA @ 32V DC				
	Reverse Voltage	< 36V DC				
<b>AC Control INPUT</b>	Voltage Range	20...260V AC/DC				
	Turn-on Voltage (min.)	≥ 15V AC/DC				
	Turn-off Voltage (max.)	≤ 6V AC/DC				
	Consumption	≤ 8mA @ 260V AC/DC				
	Frequency Range	50/60 Hz				
Activation Time		≤ 1/2 cycle				
Deactivation Time		≤ 1/2 cycle				
Critical dV/dt OFF-state	[V/μs]	1000				
Potential drop at rated current	[Vrms]	≤ 1.4				
Peak Voltage		> 1200V DC				
Protection		IP20				
<b>Isolation</b>						
Nominal voltage (U <sub>i</sub> )	[V ac]	600				
<b>Insulation</b>						
Nominal voltage input/output	[KV ac]	4				
Nominal impulse withstand (U <sub>imp</sub> )	[V AC]	2500				
<b>Ambient Conditions</b>						
Working temperature		-20...+80°C [-4°...176°F]				
Storage temperature		-20...+85°C [-4°...185°F]				
Maximum relative humidity		50% at 40°C				
Maximum installation altitude		1000m asl				
Pollution level		3 (suitable for use in degree 2 environment)				
Class		A (industrial device)				

### Dissipation Curve

GTZ 25 - 40 - 55

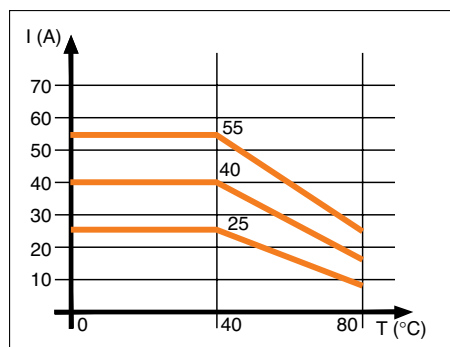

### Technical Information

#### Terminals and Conductors

Size	Nominal Section Cable mm <sup>2</sup>	Control Terminal (A1, A2, B1, B2)			Power Terminal (L1, L2, L3, T1, T2, T3)			Ground Terminal ①	
		Contact area (WxD) screw type	Type of preisolated terminal	Section conductor tightening torque ②	Contact area (WxD) screw type	Type of preisolated terminal	Max. section conductor tightening torque	Contact area (WxD) screw type	Max. section conductor tightening torque
25A	6	6.3x9 M3	Eye / fork / tip	min. 0.35 mm <sup>2</sup> max. 2.5 mm <sup>2</sup> 0.6 Nm Max	12 x 12 M5	Eye / fork / tip	<i>Tip Terminal</i> min. 1mm <sup>2</sup> (17AWG) max. 10mm <sup>2</sup> (7AWG)  <i>Eye or Fork Terminal</i> min. 1mm <sup>2</sup> (17AWG) max. 16mm <sup>2</sup> (5AWG)  1.5 ... 2.2Nm	12x12 self-tapping screw 3.9x12 DIN7981	min. 1mm <sup>2</sup> (17AWG) max. 16mm <sup>2</sup> (5AWG) 1.5 ... 1.8Nm
40A	10								
55A	16							12x12 M5	min. 1mm <sup>2</sup> (17AWG) max. 16mm <sup>2</sup> (5AWG) 2.5Nm

① Note: The maximum sections specified refer to unipolar copper wires isolated in PVC. For the ground terminal, a eye wire terminal is required.  
(WxD) = Width x depth

② The minimum acceptable nominal section based on the nominal currents of the power solid state units is given for copper conductors isolated in PVC, under continuous operating conditions and at 40°C ambient temperature according to standards CEI 44-5, CEI 17-11, IEC 408 in accordance with EN60204-1.

G  
Gefran Solid State Relays

#### Connection Examples

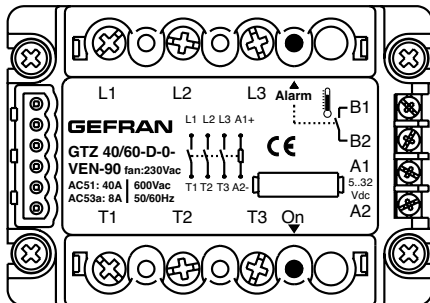

- L1 : Phase 1 input
- L2 : Phase 2 input
- L3 : Phase 3 input
- T1 : Phase 1 output
- T2 : Phase 2 output
- T3 : Phase 3 output
- A1 : Control signal (+)
- A2 : Control signal (-)
- B1 : Alarm output (+) (Special unit)
- B2 : Alarm output (-) (Special unit)
- Led1: Red led signal indicator
- Led2: Yellow led (alarm overtemperature junction)

**Series GQ Solid State Relays**

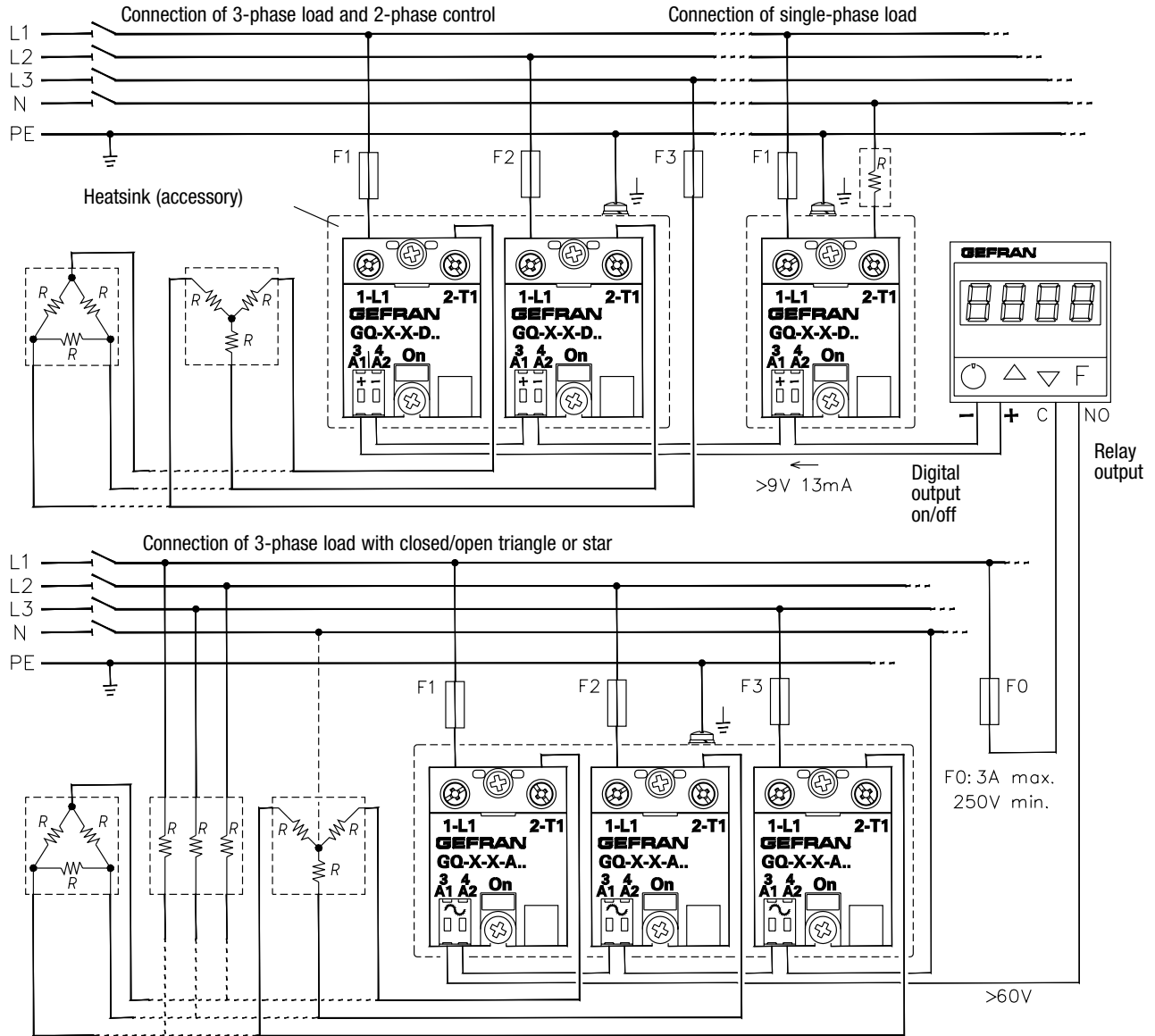

**G** Gefran Solid State Relays

**Series GQ Fuse Connections**

The solid state group must be connected using proper fuses against short circuits

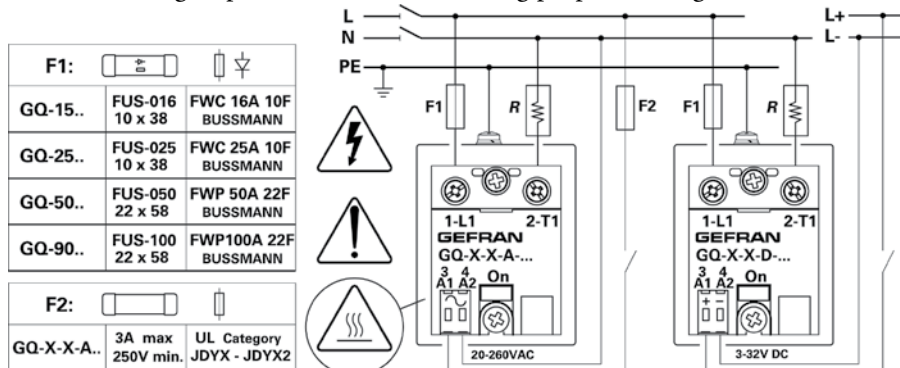

**Series GTS Solid State Relays**

Single-phase connection

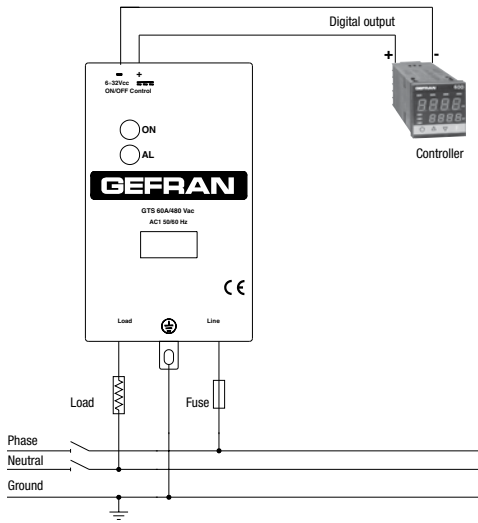

Three-phase Star connection with neutral

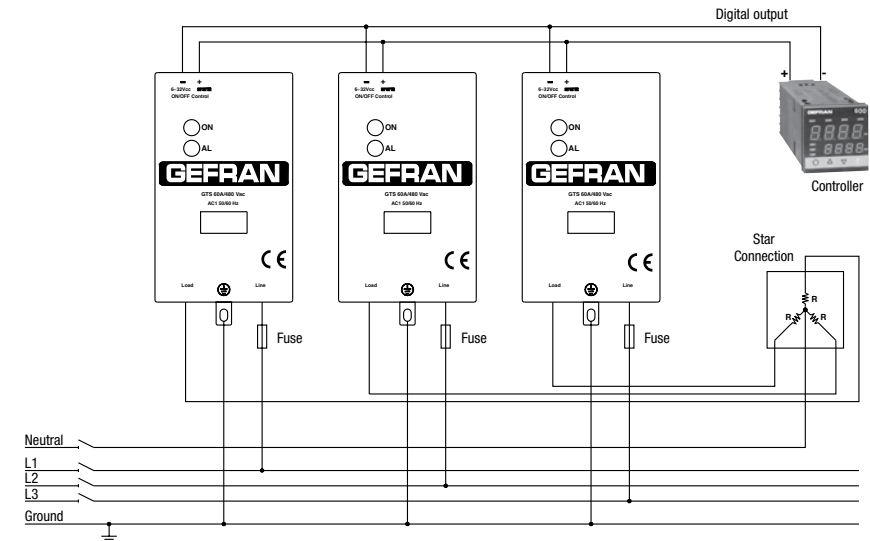

Three-phase Triangle or Star connection without neutral on two phases

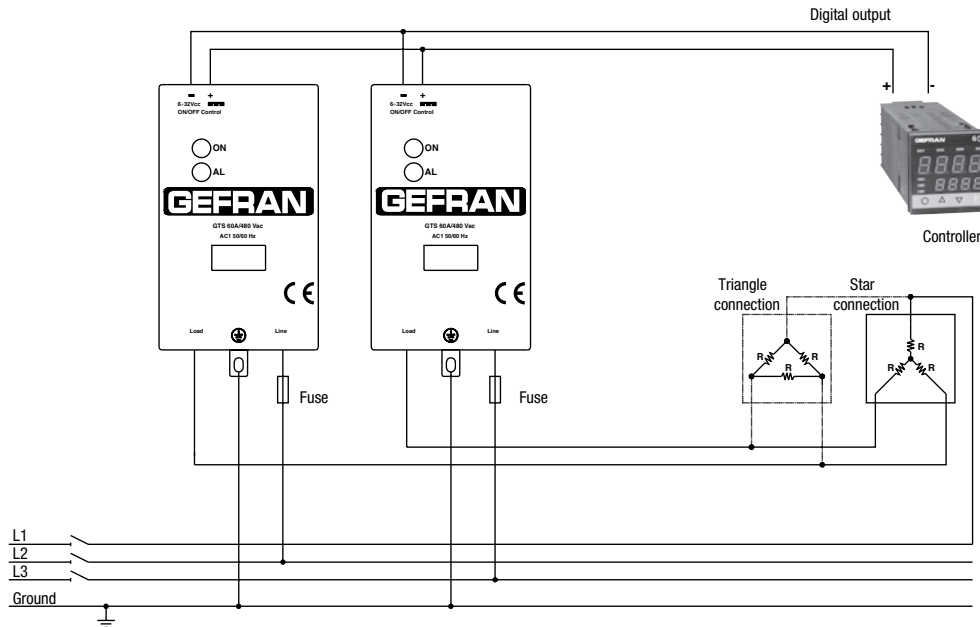

**G** GEFran Solid State Relays

**Series GTZ Solid State Relays**

Three-phase Triangle or Star connection (with and without neutral)

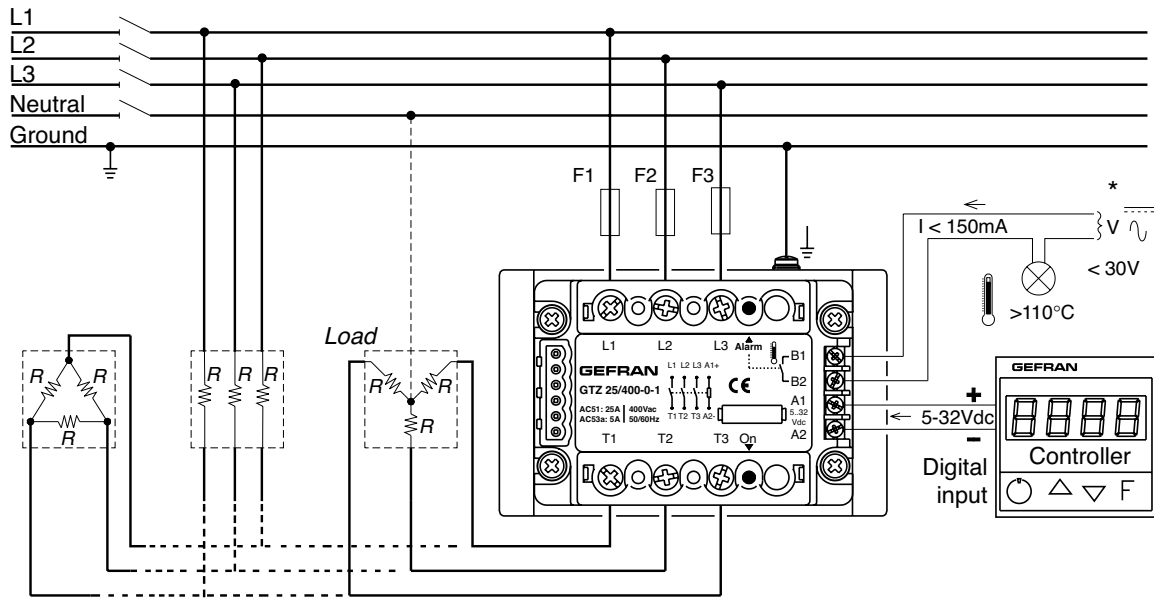

\* Only in the version with option overtemperature alarm output



**GQ Panel Mount Relays**

Dimensions are in millimeters (inches). Dimensions not intended for manufacturing purposes.

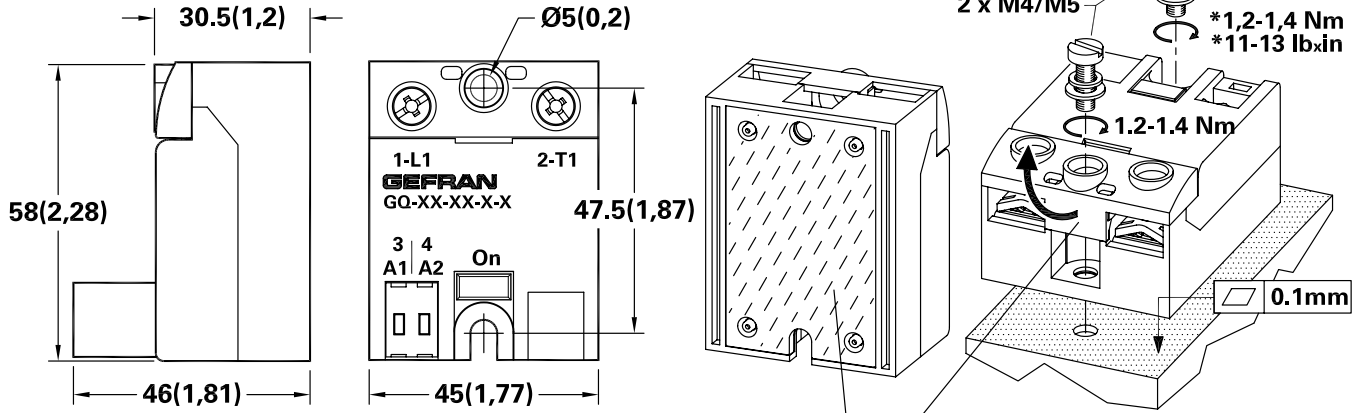

(\*) See installation notes

\*Apply thermoconductive paste

Raise the guard to access the fastening hole or the terminals

**GTS 1-Pole DIN-Rail Mount Relays**

Dimensions are in millimeters (inches). Dimensions not intended for manufacturing purposes.

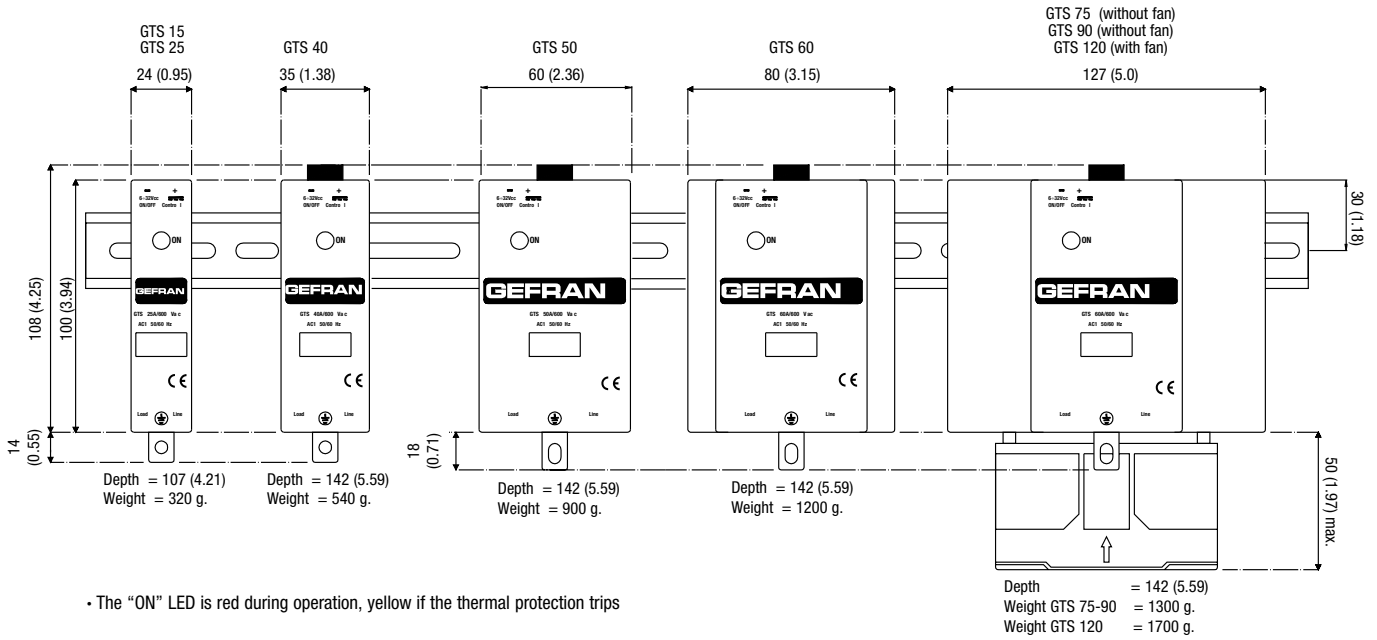

**PAN-1 Panel Mount Accessory for GTS - Hole Template**

GTS 1-Pole Relays	Length	Width
	mm (inches)	mm (inches)
GTS-15...25	112 (4.41)	0 (0.00)
GTS-40	112 (4.41)	25 (0.98)
GTS-50...60	112 (4.41)	44 (1.73)
GTS-90...120	112 (4.41)	113 (4.45)

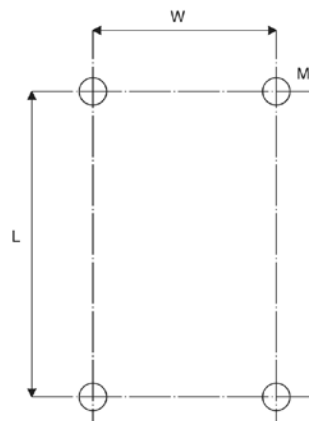

**G**  
Gefran Solid State Relays

**GTZ 3-Pole DIN-Rail Mount Relays**

