

# Rotary Cam Switches

<b>Series L2 Rotary Cam Switches</b> .....	K2
<i>Handle Assemblies</i> .....	K8
<i>Accessories</i> .....	K12
<i>Circuit Diagrams, Technical Information &amp; Dimensions (Online)</i> .....	K13
<b>Series R-Line Rotary Cam Switches</b> .....	K24
<i>Handles and Accessories</i> .....	K27
<i>Circuit Diagrams, Technical Information &amp; Dimensions (Online)</i> .....	K30



# Series L2 Rotary Cam Switches

Attractive design,  
reliable operation  
and high quality for  
any application up  
to 25 Amps

Sprecher + Schuh's comprehensive line of L2 rotary cam switches are available for all control and load applications up to 25 amps. The line is modular and has many convenience and safety features. A well thought out ordering system provides many standard and nonstandard configurations, that are many times available off the shelf.

## Any switch configuration...

Two frame sizes provide control and load switching up to 25 amps. Both frame sizes are available in panel mount and base mount for total flexibility. A wide range of switching configurations are offered, as listed below.

## ...For any application

L2 control and load switches are UL listed, CSA approved and comply with the most important international standards for use as:



- **Control switches** - for process control, making and breaking circuits and as instrument selector switches.
- **Motor switches** - as ON/OFF and reversing switches.
- **Multi-position load switches** - for the step control of loads such as heaters and furnaces.
- **Motor load disconnect switches** - for safely isolating circuits during repair and maintenance.
- **Emergency OFF switches** - for isolating circuits in case of danger or emergency situations. Can be equipped for locking in the OFF position.



## Safety and quality

The L2's sturdy design incorporates a positive switching action with a clearly designed switching point. Switch bodies are touch-safe (IP20) and manufactured from self-extinguishing materials corresponding to Class UL 94 V0. All control knobs and shafts are spray proof and dust proof to IP65.

## Modular and flexible

The same switch handle assemblies and shaft extension systems are used for both our L2 control switches and L7 disconnect switches. This reduces inventory, simplifies stocking and allows you to put together the ideal switch for your application quickly and easily.

## Simple assembly and fast installation

Shaft extensions and door interlocks snap-on quickly without tools, saving time during assembly. Captive terminals are shipped open and are totally accessible regardless of whether the switch is base mounted or panel mounted. Screwdriver guides and clear terminal markings reduce wiring mistakes and speed installation.

In addition, most switch handle assemblies are available with either screw fixing or the central nut mounting system for total flexibility.

**TIP!**



To learn the basic differences between control, load and fusible disconnect switches and how to apply them, see our white paper Tech-LMSD in the online library.

## How to order L2 control and load switches

A complete L2 switch is ordered with just two catalog numbers. The first number specifies the switch body and the second specifies the switch handle assembly. All L2 switch bodies come standard with a shaft and mounting screws for the switch handle assembly. Accessories such as shaft extensions and enclosures are ordered separately.

First determine the switch body you need from pages K4 through K7. Then turn to page K8 to choose a switch handle assembly. If necessary, turn to page K10 and K11 to determine the type and length of shaft extension you require.

Switch Handle Assemblies - page K8

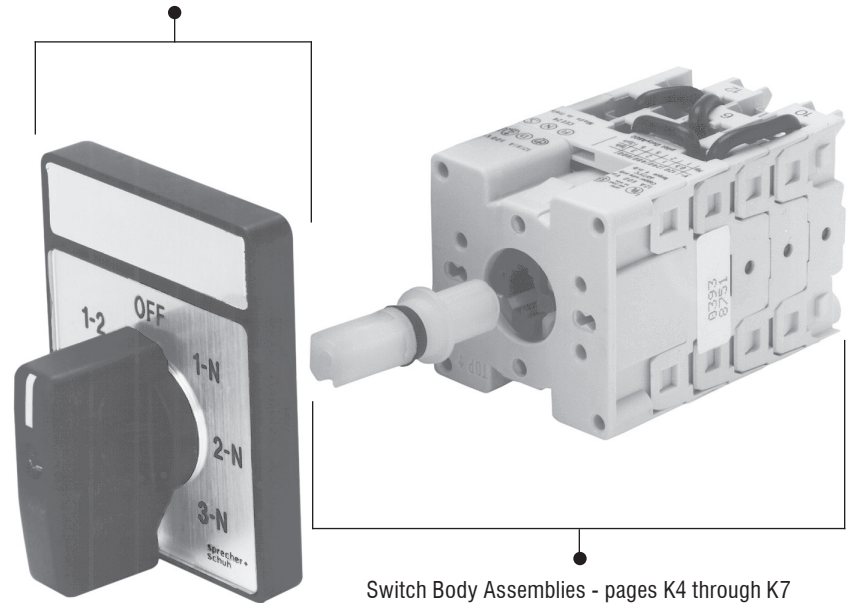

Switch Body Assemblies - pages K4 through K7

## A comprehensive family of switches

The L2 line is part of an entire family of control and load switches available from Sprecher + Schuh.

For specialized switching requirements or large ampere applications up to 40A (@600V), our R-Line Rotary Cam Switches offer a broad selection and rugged quality. See the next chapter in this section entitled “R-Line Rotary Cam Switches” (K24) for ordering information.

Our modular L7 disconnect switches are rated to 100 amps for motor, loads and disconnect switching. They share many of the same components with the L2 line. A complete description and ordering information can be found in Section L of this catalog.

Rounding out our selection of “man-machine interfaces,” Sprecher + Schuh also offers a broad selection of 22mm pilot devices. See “Section H” in this catalog for ordering information.

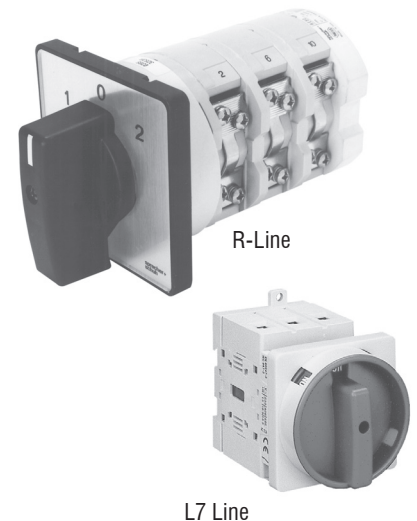

**K**

**L2 Rotary Cam Switches**

Switch Body Description			Switch Body Catalog Number				Switch Handle Code			
Function	Switch Angle	Poles/Switch Wafers	Panel Mount							
			12 Amp	16 Amp	20 Amp	25 Amp				
<b>ON - OFF</b>										
	90°	1 / 1	LE2-12-1751	LE2-16-1751	LE2-20-1751	LE2-25-1751	175 175I			
		2 / 1	LE2-12-1752	LE2-16-1752	LE2-20-1752	LE2-25-1752				
		3 / 2	LE2-12-1753	LE2-16-1753	LE2-20-1753	LE2-25-1753				
		4 / 2	LE2-12-1754	LE2-16-1754	LE2-20-1754	LE2-25-1754				
		5 / 3	LE2-12-1755	LE2-16-1755	LE2-20-1755	LE2-25-1755				
		6 / 3	LE2-12-1756	LE2-16-1756	LE2-20-1756	LE2-25-1756				
	90°	1 / 1	LE2-12-1781	LE2-16-1781	LE2-20-1781	LE2-25-1781	178 178I			
		2 / 1	LE2-12-1782	LE2-16-1782	LE2-20-1782	LE2-25-1782				
		3 / 2	LE2-12-1783	LE2-16-1783	LE2-20-1783	LE2-25-1783				
		4 / 2	LE2-12-1784	LE2-16-1784	LE2-20-1784	LE2-25-1784				
		<b>Double Throw</b>								
			45°	1 / 1	LE2-12-2251	LE2-16-2251		LE2-20-2251	LE2-25-2251	225
2 / 2	LE2-12-2252			LE2-16-2252	LE2-20-2252	LE2-25-2252				
3 / 3	LE2-12-2253			LE2-16-2253	LE2-20-2253	LE2-25-2253				
4 / 4	LE2-12-2254			LE2-16-2254	LE2-20-2254	LE2-25-2254				
5 / 5	LE2-12-2255			LE2-16-2255	LE2-20-2255	LE2-25-2255				
	60°			1 / 1	LE2-12-2501	LE2-16-2501	LE2-20-2501	LE2-25-2501	250	
		2 / 2	LE2-12-2502	LE2-16-2502	LE2-20-2502	LE2-25-2502				
		3 / 3	LE2-12-2503	LE2-16-2503	LE2-20-2503	LE2-25-2503				
		4 / 4	LE2-12-2504	LE2-16-2504	LE2-20-2504	LE2-25-2504				
		5 / 5	LE2-12-2505	LE2-16-2505	LE2-20-2505	LE2-25-2505				
			45°	1 / 1	LE2-12-3251	LE2-16-3251	LE2-20-3251	LE2-25-3251		325 325R
2 / 2	LE2-12-3252			LE2-16-3252	LE2-20-3252	LE2-25-3252				
3 / 3	LE2-12-3253			LE2-16-3253	LE2-20-3253	LE2-25-3253				
4 / 4	LE2-12-3254			LE2-16-3254	LE2-20-3254	LE2-25-3254				
	60°			1 / 1	LE2-12-3501	LE2-16-3501	LE2-20-3501	LE2-25-3501	350	
				2 / 2	LE2-12-3502	LE2-16-3502	LE2-20-3502	LE2-25-3502		
		3 / 3	LE2-12-3503	LE2-16-3503	LE2-20-3503	LE2-25-3503				
		4 / 4	LE2-12-3504	LE2-16-3504	LE2-20-3504	LE2-25-3504				
			90°	1 / 1	LE2-12-3751	LE2-16-3751	LE2-20-3751	LE2-25-3751		375
				2 / 2	LE2-12-3752	LE2-16-3752	LE2-20-3752	LE2-25-3752		
3 / 3	LE2-12-3753			LE2-16-3753	LE2-20-3753	LE2-25-3753				
4 / 4	LE2-12-3754			LE2-16-3754	LE2-20-3754	LE2-25-3754				
	45°			1 / 1	LE2-12-3261	LE2-16-3261	LE2-20-3261	LE2-25-3261	325	
				2 / 2	LE2-12-3262	LE2-16-3262	LE2-20-3262	LE2-25-3262		
		3 / 3	LE2-12-3263	LE2-16-3263	LE2-20-3263	LE2-25-3263				

**K** L2 Rotary Cam Switches

**Ordering Instructions**

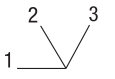
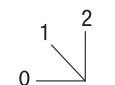
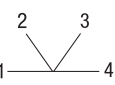
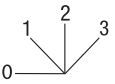
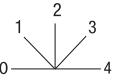
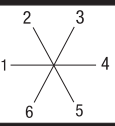
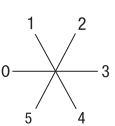

- Specify Switch Body catalog# from top of column.
- Replace (▲) with Circuit Diagram Number (refer to pages K13-K16 for diagrams).
- Select Switch Handle Assembly from pages K8 using Switch Handle Code above (switch handles sold separately).
- Example: **LE2-16-1753** (Switch Body)  
**LFS2-A-4-175** (Switch Handle Assembly)

Switch Body Description			Switch Body Catalog Number				Switch Handle Code
Function	Switch Angle	Poles/ Switch Wafers	Panel Mount				
			12 Amp	16 Amp	20 Amp	25 Amp	
<b>3 Position</b>							
	60°	1 / 2 2 / 3 3 / 5	LE2-12-4501 LE2-12-4502 LE2-12-4503	LE2-16-4501 LE2-16-4502 LE2-16-4503	LE2-20-4501 LE2-20-4502 LE2-20-4503	LE2-25-4501 LE2-25-4502 LE2-25-4503	450
<b>3 Position (with OFF)</b>							
	45°	1 / 1 2 / 2 3 / 3	LE2-12-5251 LE2-12-5252 LE2-12-5253	LE2-16-5253	LE2-20-5252	LE2-25-5252 LE2-25-5253	525
<b>4 Position</b>							
	60°	1 / 2 2 / 4 3 / 6	LE2-12-4511 LE2-12-4512 LE2-12-4513	LE2-16-4511 LE2-16-4512 LE2-16-4513		LE2-25-4512 LE2-25-4513	451
<b>4 Position (with OFF)</b>							
	45°	1 / 2 2 / 3 3 / 5	LE2-12-5261 LE2-12-5262 LE2-12-5263	LE2-16-5261 LE2-16-5262 LE2-16-5263	LE2-20-5261 LE2-20-5262 LE2-20-5263	LE2-25-5261 LE2-25-5262 LE2-25-5263	526
<b>5 Position (with OFF)</b>							
	45°	1 / 2 2 / 4 3 / 6	LE2-12-5271 LE2-12-5272 LE2-12-5273	LE2-16-5271 LE2-16-5272 LE2-16-5273	LE2-20-5271 LE2-20-5272 LE2-20-5273	LE2-25-5271 LE2-25-5272 LE2-25-5273	527
<b>6 Position</b>							
	60°	1 / 3	LE2-12-4531	LE2-16-4531	LE2-20-4531	LE2-25-4531	453
<b>6 Position (with OFF)</b>							
	60°	1 / 3 2 / 5 3 / 8	LE2-12-5531 LE2-12-5532 LE2-12-5533	LE2-16-5531 LE2-16-5532 LE2-16-5533	LE2-20-5531 LE2-20-5532 LE2-20-5533	LE2-25-5531 LE2-25-5532 LE2-25-5533	553

**K**  
L2 Rotary Cam Switches

**Ordering Instructions**

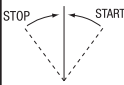
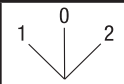
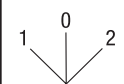
- Specify Switch Body catalog# from top of column.
- Replace (▲) with Circuit Diagram Number (refer to pages K13-K16 for diagrams).
- Select Switch Handle Assembly from pages K8 using Switch Handle Code above (switch handles sold separately).
- Example: **LE2-16-1753** (Switch Body)  
**LFS2-A-4-175** (Switch Handle Assembly)

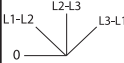
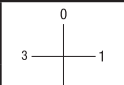



Switch Body Description			Switch Body Catalog Number				Switch Handle Code
Function	Switch Angle	Poles/ Switch Wafers	Panel Mount				
			12 Amp	16 Amp	20 Amp	25 Amp	
<b>START - STOP</b>							
	45°	1 / 1	LE2-12-9251	LE2-16-9251	LE2-20-9251	LE2-25-9251	925
<b>REVERSING</b>							
	45°	3 / 3	LE2-12-7303	LE2-16-7303	LE2-20-7303	LE2-25-7303	325
<b>Two Speed Single Winding (Dahlander)</b>							
	45°	3 / 4	LE2-12-7293	LE2-16-7293	LE2-20-7293	LE2-25-7293	325
<b>Voltmeter</b>							
	45	NA / 3	LE2-12-8251	LE2-16-8251	LE2-20-8251	LE2-25-8251	825 825A
	45°	NA / 2	LE2-12-8271	LE2-16-8271	LE2-20-8271	LE2-25-8271	827 827A
<b>Ammeter</b>							
	90°	1 / 3	LE2-12-8751	LE2-16-8751	LE2-20-8751	LE2-25-8751	875
3 Current Transformers		2 / 5	LE2-12-8752	LE2-16-8752	LE2-20-8752	LE2-25-8752	





**Ordering Instructions**

- Specify Switch Body catalog# from top of column.
- Replace (▲) with Circuit Diagram Number (refer to pages K13-K16 for diagrams).
- Select Switch Handle Assembly from pages K8 using Switch Handle Code above (switch handles sold separately).
- Example: **LE2-16-1753** (Switch Body)  
**LFS2-A-4-175** (Switch Handle Assembly)

Switch Body Description			Switch Body Catalog Number				Switch Handle Code
Function	Switch Angle	Poles/Switch Wafers	Base Mount				
			12 Amp	16 Amp	20 Amp	25 Amp	
<b>ON - OFF</b>							
	90°	1 / 1	LA2-12-1751	LA2-16-1751	LA2-20-1751	LA2-25-1751	175 175I
		2 / 1	LA2-12-1752	LA2-16-1752	LA2-20-1752	LA2-25-1752	
		3 / 2	LA2-12-1753	LA2-16-1753	LA2-20-1753	LA2-25-1753	
		4 / 2	LA2-12-1754	LA2-16-1754	LA2-20-1754	LA2-25-1754	
		5 / 3	LA2-12-1755	LA2-16-1755	LA2-20-1755	LA2-25-1755	
		6 / 3	LA2-12-1756	LA2-16-1756	LA2-20-1756	LA2-25-1756	
	90°	1 / 1	LA2-12-1781	LA2-16-1781	LA2-20-1781	LA2-25-1781	178 178I
		2 / 1	LA2-12-1782	LA2-16-1782	LA2-20-1782	LA2-25-1782	
		3 / 2	LA2-12-1783	LA2-16-1783	LA2-20-1783	LA2-25-1783	
		4 / 2	LA2-12-1784	LA2-16-1784	LA2-20-1784	LA2-25-1784	
<b>Double Throw</b>							
	45°	1 / 1	LA2-12-2251	LA2-16-2251	LA2-20-2251	LA2-25-2251	225
		2 / 2	LA2-12-2252	LA2-16-2252	LA2-20-2252	LA2-25-2252	
	45°	1 / 1	LA2-12-3251	LA2-16-3251	LA2-20-3251		325 325R
		2 / 2	LA2-12-3252	LA2-16-3252	LA2-20-3252		
		3 / 3	LA2-12-3253	LA2-16-3253	LA2-20-3253		
		4 / 4	LA2-12-3254	LA2-16-3254	LA2-20-3254		
<b>4 Position (with OFF)</b>							
	45°	1 / 2	LA2-12-5261	LA2-16-5261	LA2-20-5261	LA2-25-5261	526
<b>5 Position (with OFF)</b>							
	45°	1 / 2	LA2-12-5271	LA2-16-5271	LA2-20-5271	LA2-25-5271	527
<b>START - STOP</b>							
	45°	1 / 1	LA2-12-9251	LA2-16-9251	LA2-20-9251	LA2-25-9251	925
<b>REVERSING</b>							
	45°	3 / 3	LA2-12-7303	LA2-16-7303	LA2-20-7303	LA2-25-7303	325
<b>Voltmeter</b>							
	45°	NA / 3	LA2-12-8251	LA2-16-8251	LA2-20-8251	LA2-25-8251	825 825A
		NA / 2	LA2-12-8271				827 827A
<b>Ammeter</b>							
	90°	1 / 3 2 / 5	LA2-12-8751	LA2-16-8751	LA2-20-8751	LA2-25-8751	875

### Switch Handle Assemblies

Switch Handle Assembly	Mounting Method	Frame Size	Catalog Number
 <p><b>Type A - Type 12</b> Silver Legend Plate - Black Knob</p>	Screw ①③	48 x 48	LFS2-A-4-*
		64 x 64	LFS2-A-6-*
 <p><b>Type E - Type 12</b> Silver Legend Plate - Black Knob</p>	Screw ①③	48 x 48	LFS2-E-4-*
		64 x 64	LFS2-E-6-*
 <p><b>Type I - Type 12</b> Yellow Legend Plate - Red Knob</p>	Screw ①③	48 x 48	LFS2-I-4-*
		64 x 64	LFS2-I-6-*
 <p><b>Type L - Type 12</b> Yellow Legend Plate - Red Knob</p>	Screw ①③	48 x 48	LFS2-L-4-*
		64 x 64	LFS2-L-6-*
 <p><b>Type I - Type 12</b> Yellow Legend Plate - Red Knob</p>	Central Nut ②③	48 x 48	LFC2-I-4-*
		48 x 48	LFC2-L-4-*





Switch Handle Assembly	Mounting Method	Frame Size	Catalog Number
 <p><b>Type G - Type 12</b> Grey Frame - Black Handle</p>	Screw ①	67 x 67	LFS2-G-6-175
		Central Nut ②	67 x 67
 <p><b>Type N - Type 12</b> Yellow Frame - Red Handle</p>	Screw ①	67 x 67	LFS2-N-6-175
		Central Nut ②	67 x 67
 <p><b>Type B - Type 12</b> Grey Ring - Black Knob</p>	Central Nut ②	NA	LFC2-B-001
 <p><b>Type C - Type 12</b> Silver Legend Plate</p>	Central Nut ②	48x48	LFC2-C◆-4-*

K  
L2 Rotary Cam Switches

#### Ordering Instructions

- Specify Switch Body catalog# from top of column.
- Replace (\*) with Switch Handle Code Number (refer to pages K9) for Legend Plate desired.

- Where applicable replace (◆) with Key Withdraw Code.

C =  D =  G =  H =  K = 

- Example: LFC2-C◆-4-\* = LFC2-CK-4-553

- Mounting screws included with Switch Body Assy.
- Central Nut mounting method cannot be used on LA style Switch Body Assemblies.
- To order Switch Handle Assembly without legend plate, replace (\*) with "001".
- LFS(C)2-G(N)-6-175 handles are marked "I-ON" and "O-OFF".



### Switch Handle Codes

Switch Handle Code	Standard Legend Markings ④	Frame Size ①	Switch Handle Assembly Type																			
			Screw Mount						Central Nut													
			A	E	I	L	G	N	A	E	I	L	C	G	N							
000		Standard	•	•	•	•		•	•	•	•											
		Larger	•	•	•	•					•											
175		Standard	•	•	•	•	•	•	•	•	•	•	•	•	•	•	•	•	•	•	•	•
		Larger	•	•	•	•					•											•
175I		Standard	•	•	•	•	•	•	•	•	•	•	•	•	•	•	•	•	•	•	•	•
		Larger	•	•	•	•					•											•
178		Standard	•	•	•	•		•	•	•	•											
		Larger	•	•	•	•					•											
178I		Standard	•	•	•	•		•	•	•	•											
		Larger	•	•	•	•					•											
225		Standard	•					•														•
		Larger	•																			
250		Standard	•					•														•
		Larger	•																			
325		Standard	•					•														•
		Larger	•																			
325R		Standard	•					•														•
		Larger	•																			
350 ②		Standard	•					•														•
		Larger	•																			
375		Standard	•					•														•
		Larger	•																			
450		Standard	•					•														•
		Larger	•																			

Switch Handle Code	Standard Legend Markings ④	Frame Size ①	Switch Handle Assembly Type																			
			Screw Mount						Central Nut													
			A	E	I	L	G	N	A	E	I	L	C	G	N							
451		Standard	•																			•
		Larger	•																			
453		Standard	•																			•
		Larger	•																			
525		Standard	•																			•
		Larger	•																			
526		Standard	•																			•
		Larger	•																			
527		Standard	•																			•
		Larger	•																			
553		Standard	•																			•
		Larger	•																			
825		Standard	•																			•
		Larger	•																			
825A		Standard	•																			•
		Larger	•																			
827		Standard	•																			•
		Larger	•																			
827A		Standard	•																			•
		Larger	•																			
875		Standard	•																			•
		Larger	•																			
925		Standard	•																			•
		Larger	•																			

① Frame Size descriptions:

Type: A, E, I & L    C    N & G  
 Standard: **48x48**    **48x48**    **67X67**  
 Larger: **64x64**

② Available with "MAN-O-AUTO" or "HAND-O-AUTO" legend marking.

③ LFS(C)2-G(N)-6-175 handles are marked "I-ON" and "O-OFF".

④ For legend plate markings not included here, see page K17 for Custom Name Plates. **NOTE:** Types "N" and "G" are not available with custom markings.

**K**  
L2 Rotary Cam Switches

## Modular shaft extension system

Shaft Extension Modules are ideal for lengthening the shaft of an LA2 switch up to 144mm (≈5.5"). These rugged polycarbonate modules are 24mm (≈15/16") long and snap on "piggyback" to one another without the use of tools. Strong center shafts interlock as each module is snapped together. The standard 44mm End Shaft supplied with every LA2 switch connects the last Extension Module with the Switch Handle Assembly. End Shafts of 52 and 57mm are also available, making this modular system versatile, fast and economical. Shaft Extension Modules are supplied two per package.

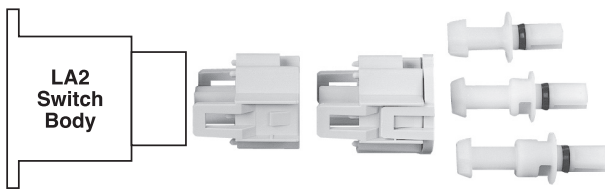

### Determining modular shaft extension components

- Determine Mounting Depth. This is the distance from the inside mounting surface of the enclosure to the **outside surface** of the enclosure cover. See diagram below for details ❶.

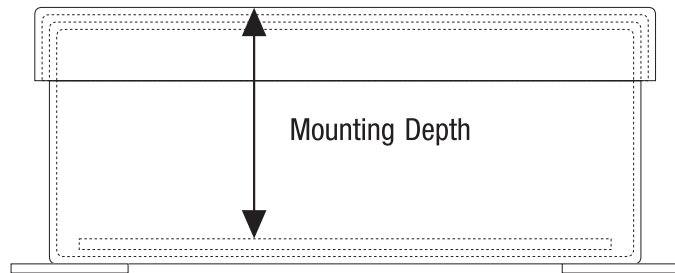

- If necessary convert Mounting Depth inches to millimeters (inches x 25.4 = millimeters).
  - In the Modular Shaft Extension Table to the right, find the Mounting Depth in the column under the appropriate LA2 Switch Body.
- NOTE:** Table is based on an LA2 switch body with two wafers (3 or 4 pole). For a switch body with more or less wafers, add or subtract the following from overall Mounting Depth before referring to table:
- LA2-12/16 Switch Body- ±10mm per wafer
  - LA2-20/25 Switch Body- ±12.5mm per wafer
- Order the End Shaft and number of Extension Modules required for that Mounting Depth.

### Modular Shaft Extension Components (LA2 Base Mount)

Component	Catalog Number
<b>44mm End Shaft</b> ② (supplied with LA2 Switch Body Assembly)	<b>LA2-G2830</b>
<b>52mm End Shaft</b>	<b>LA2-G3194</b>
<b>57mm End Shaft</b>	<b>LA2-G3195</b>
<b>Extension Module</b> (two per pkg - priced per pkg)	<b>LA2-G2853</b>

### Modular Shaft Extension Table

Number of Extension Modules	Required End Shaft	Mounting Depth (mm) ❶	
		Switch body LA2-12/16	Switch Body LA2-20/25
0	44mm ②	71.5 - 77.5	75 - 80.5
0	52mm	77 - 87	80 - 90
0	57mm	82 - 92	85 - 95
1	44mm ②	99.5 - 101.5	99 - 105
1	52mm	97.5 - 111	101 - 114.5
1	57mm	102.5 - 116	106 - 119.5
2	44mm ②	119.5 - 125.5	123 - 129
2	52mm	121.5 - 135	125 - 138.5
2	57mm	126.5 - 140	130 - 143.5
3	44mm ②	143.5 - 149.5	147 - 153
3	52mm	145.5 - 159	149 - 162.5
3	57mm	150.5 - 164	154 - 167.5
4	44mm ②	167.5 - 173.5	171 - 177
4	52mm	169.5 - 183	173 - 186.5
4	57mm	169.5 - 183	178 - 191.5
5	44mm ②	191.5 - 197.5	195 - 201
5	52mm	193.5 - 207	197 - 210.5
5	57mm	198.5 - 212	202 - 215.5
6	44mm ②	215.5 - 221.5	219 - 225
6	52mm	217.5 - 231	221 - 234.5
6	57mm	222.5 - 236	226 - 239.5

❶ For DIN rail mounted devices, remember to deduct the offset distance provided by the rail. For example, deduct 2.5mm from the Mounting Depth for switch bodies mounted on DIN 46277 rail.  
 ② One 44mm End Shaft is supplied with all Switch Body Assemblies.

## Metal shaft extension system

Adjustable metal shaft extensions snap on securely to LA2 switches via the same quick-connect design as shaft extension modules. Metal shafts are equipped with a door interlock and a padlock hasp for locking out the switch after the enclosure is opened (for outside lockout, select a Switch Handle Assembly with lockout capability).

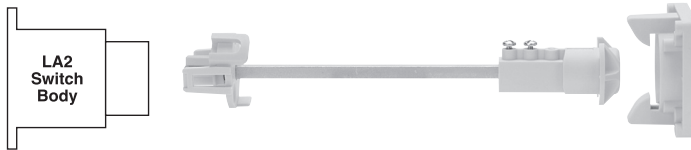

Two standard lengths of these unique adjustable shafts are available. Metal shaft extensions mate with any of the standard Switch Handle Assemblies. All necessary hardware is supplied with the shaft.

### Determining metal shaft extension

- Determine Mounting Depth. This is the distance from the inside mounting surface of the enclosure to the **outside surface** of the enclosure cover. See diagram below for details ❶.

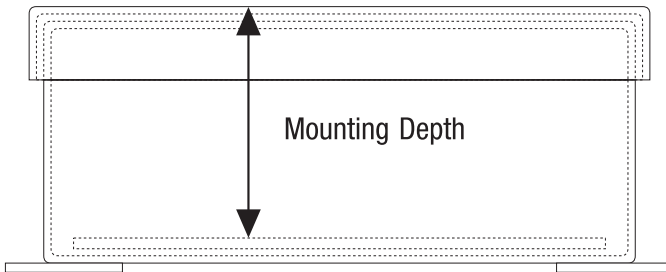

- If necessary convert Mounting Depth inches to millimeters (inches x 25.4 = millimeters).
- In the Metal Shaft Extension Table to the right, find the Mounting Depth in the column under the appropriate LA2 Switch Body.

**NOTE:** Table is based on an LA2 switch body with two wafers (3 or 4 pole). For a switch body with more or less wafers, add or subtract the following from overall Mounting Depth before referring to table:





- LA2-12/16 Switch Body- ±10mm per wafer
- LA2-20/25 Switch Body- ±12.5mm per wafer

- Order the Metal Shaft Extension required for that Mounting Depth.

❶ For DIN rail mounted devices, remember to deduct the offset distance provided by the rail. For example, deduct 2.5mm from the Mounting Depth for switch bodies mounted on DIN 46277 rail.

❷ This dimension can be reduced by another 55mm by cutting the plastic sleeve and further cutting the metal shaft.







## Metal Shaft Extension Components (LA2 Base Mount)



Component	Catalog Number
 Length: 10 . . . 235mm (4-21/64...9-1/4 in.)	LA2-G3393
 Length: 230 . . . 350mm (9-3/64...13-51/64 in.)	LA2-G3394
 Insert - For modifying metal shaft to switch position	LA2-G3398
 Insert - For modifying metal shaft to switch any position (not lockable)	LA2-G3399

## Metal Shaft Extension Table

Metal Shaft Extension	Mounting Depth (mm) ❶	
	Switch body LA2-12/16	Switch Body LA2-20/25
LA2-G3393	178 ❷ - 309	181.5 ❷ - 312.5
LA2-G3394	298 - 424	301.5 - 427.5

#### L2 Switch Accessories

Accessory	Description	Catalog No.
 (Plastic Reducer included)	<b>End Shaft for LE switch</b> <ul style="list-style-type: none"> <li>Replacement 44mm shaft supplied standard with all switches</li> <li><b>Sold only in packages of 5. Order 5 pieces to receive 1 pkg of 5.</b></li> </ul>	<b>L2-G3380</b>
	<b>Terminal cover</b> 3 or 4 pole LE2-12/16 LE2-20/25 LA2-12/16 LA2-20/25	<b>LE2-12-C4</b> <b>LE2-20-C4</b> <b>LA2-12-C4</b> <b>LA2-20-C4</b>
	<b>Standard knob</b> Black 37.5mm Black 48mm Red 37.5mm Red 48mm	<b>L2-G3154N</b> <b>L2-G3155N</b> <b>L2-G3154R</b> <b>L2-G3155R</b>
	<b>Padlockable knob</b> Black Red	<b>L2-G2864N</b> <b>L2-G2864R</b>
	<b>Type "P" knob</b> Black Red	<b>L2-G2888N</b> <b>L2-G2888R</b>
	<b>Self contained knob -</b> allows mounting LE2 switches without Switch Handle Assembly IP40 protection IP65 protection	<b>L2-G2851N</b> <b>L2-G2854N</b>
	<b>Legend Plate -</b> Blank for engraving Silver For 48 x 48 (or 62) For 64 x 64 (or 78) Yellow For 48 x 48 (or 62) For 64 x 64 (or 78)	<b>LL2-A-4-000</b> <b>LL2-A-6-000</b> <b>LL2-I-4-000</b> <b>LL2-I-6-000</b>

Accessory	Description	Catalog No.
	<b>Switch handle assembly for 45mm standard cutout</b> O-I OFF-ON Blank	<b>LFS2-P-4-175</b> <b>LFS2-P-4-175I</b> <b>LFS2-P-4-000</b>
	<b>ABS Enclosure – For High Impact Applications</b> (IP66, UL 94 Flame Resistance - HB) With pre-drilled holes for 64 x 64 operator or larger 95x150x86mm 95x150x111mm Without holes 95x150x86mm 95x150x111mm	<b>LA2-G3572</b> <b>LA2-G3573</b> <b>LA2-G3574</b> <b>LA2-G3575</b>
	<b>Noryl Enclosure – For Corrosion Prone Applications</b> (IP66, UL 94 Flame Resistance - V0) With pre-drilled holes for 64 x 64 operator or larger 95x150x86mm 95x150x111mm Without holes 95x150x86mm 95x150x111mm	<b>LA2-G3576</b> <b>LA2-G3577</b> <b>LA2-G3578</b> <b>LA2-G3579</b>

#### Enclosure Selection Guide

Determine switch & number of poles; order enclosure and shaft required

Base Mount Switch	Poles	Use Enclosure...	Shaft Required ①
LA2-12 & 16	1	LA2-G357(2,4,6,8)	LA2-G3195
	2		Standard
LA2-20 & 25	1	LA2-G357(3,5,7,9)	LA2-G3194
	2		Standard
LA2-12 & 16	3	LA2-G357(3,5,7,9)	LA2-G3195
	4		LA2-G3194
	5		Standard
LA2-20 & 25	3	LA2-G357(3,5,7,9)	LA2-G3194
	4		Standard

① Order shafts from page K11.

**Circuit Diagrams**

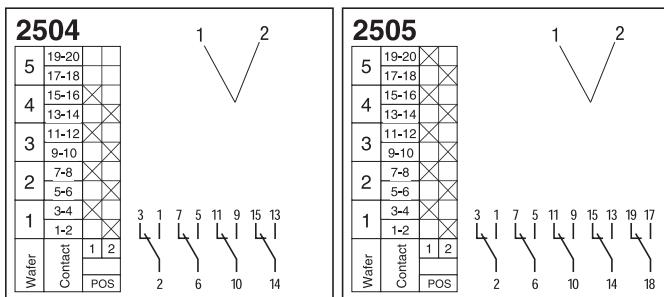
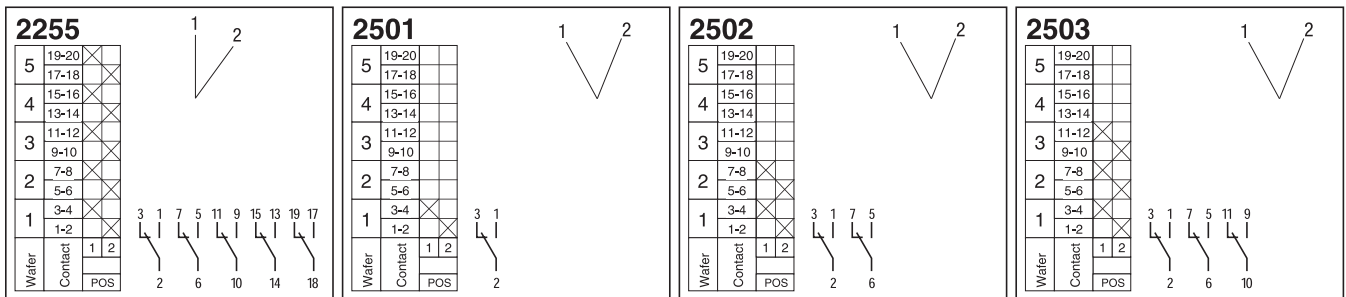
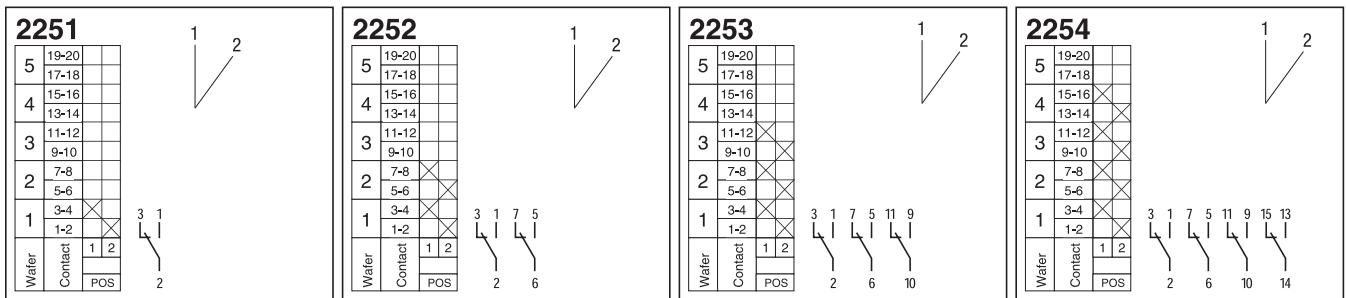
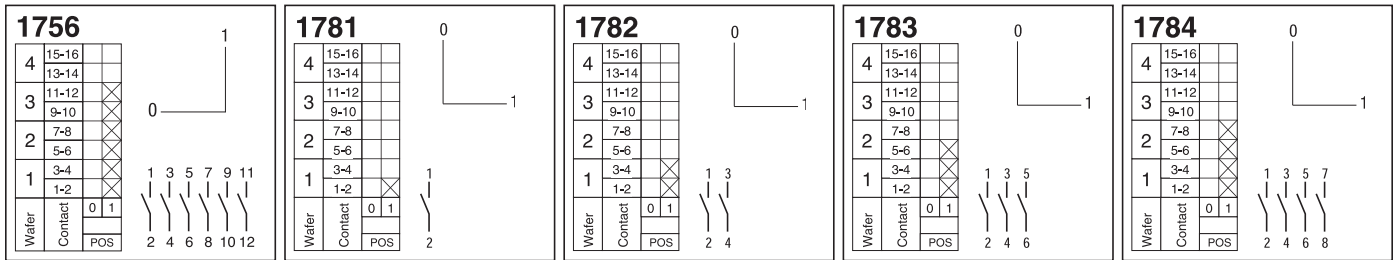
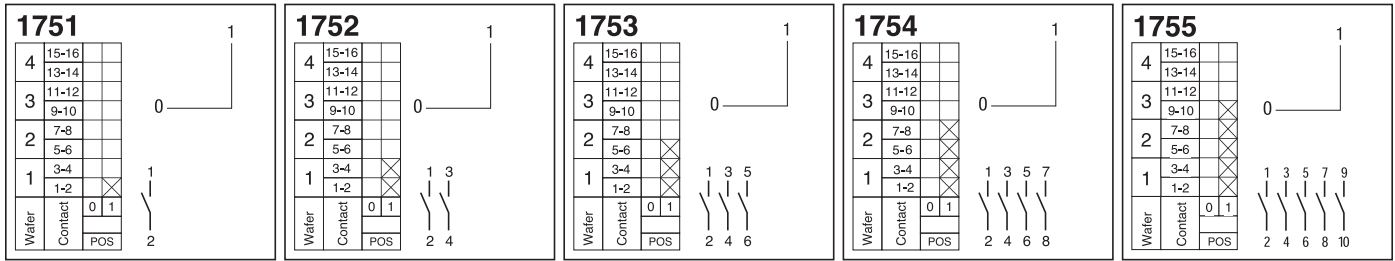

**K**  
L2 Rotary Cam Switches

### Circuit Diagrams

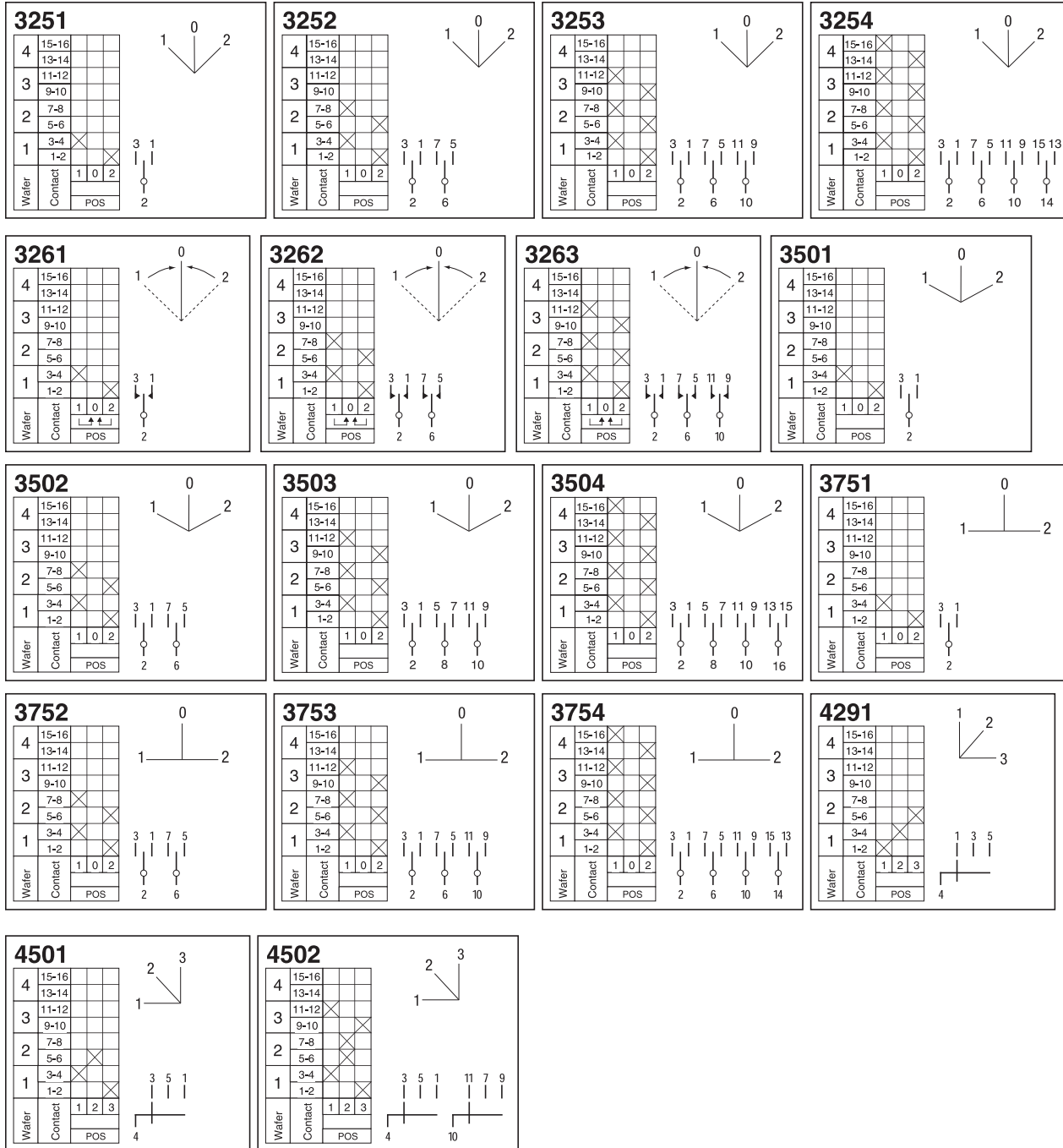

K L2 Rotary Cam Switches

### Circuit Diagrams

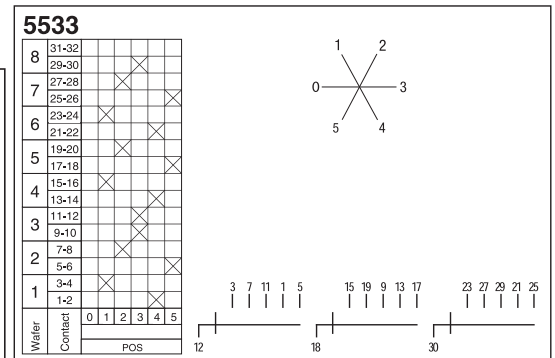
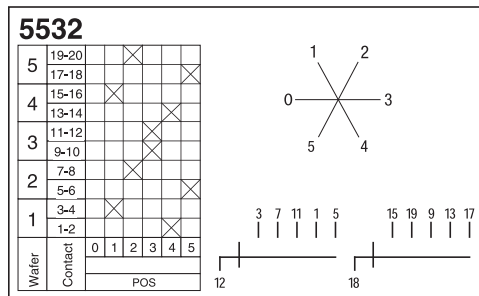
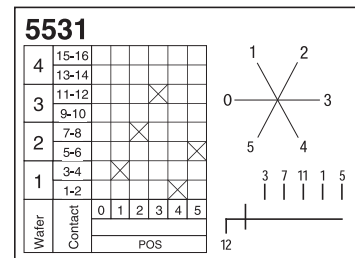
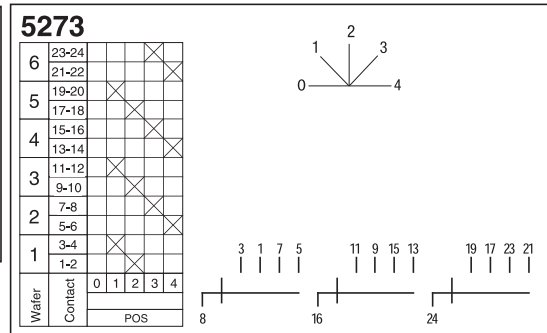
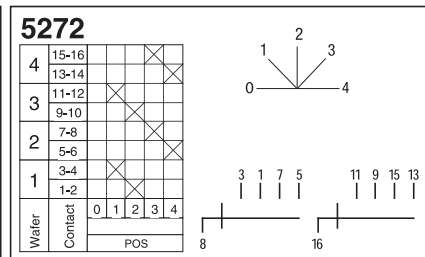
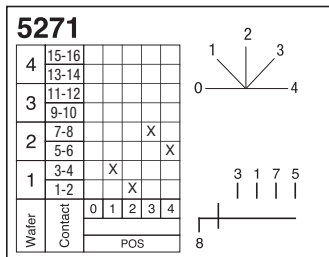
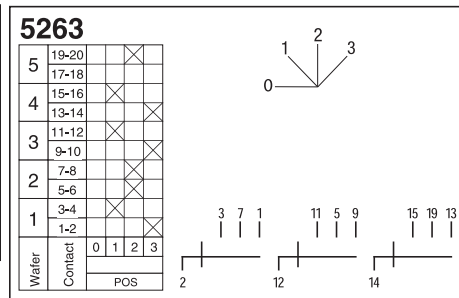
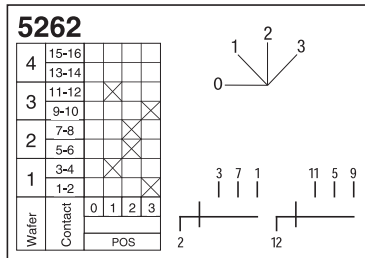
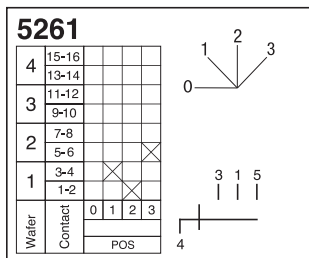
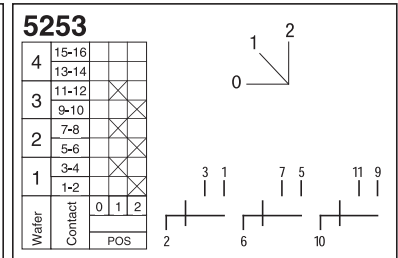
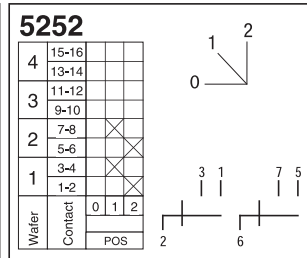
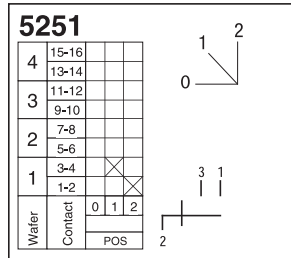
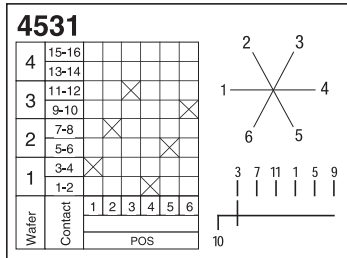
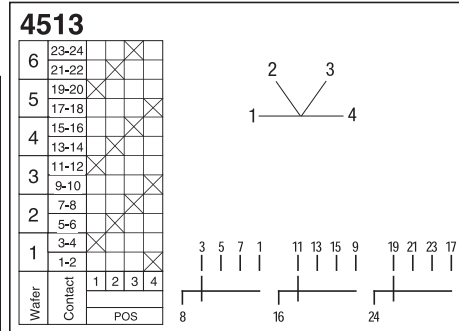
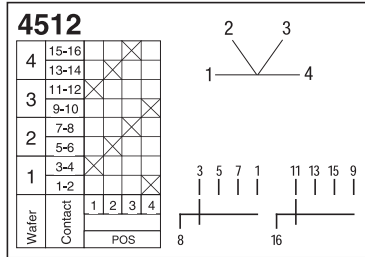
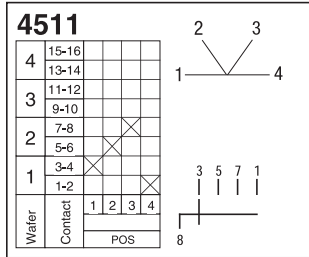

### Circuit Diagrams

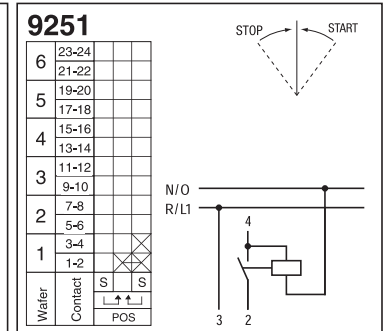
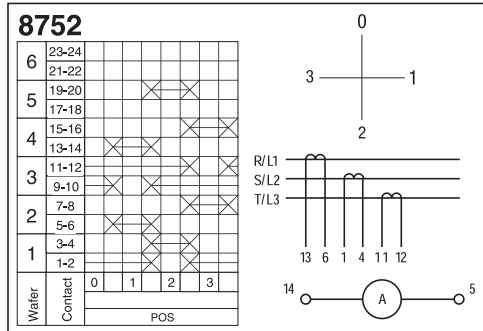
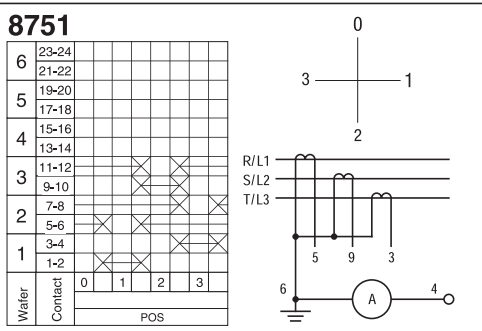
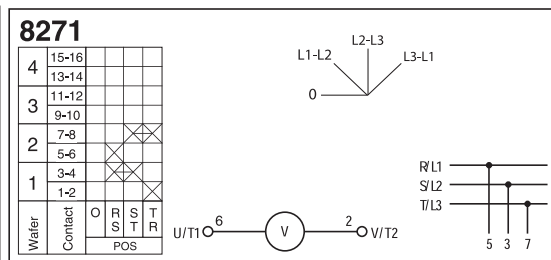
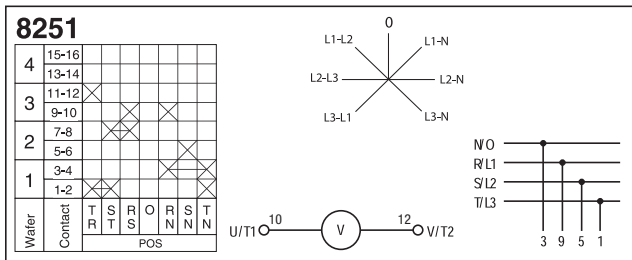
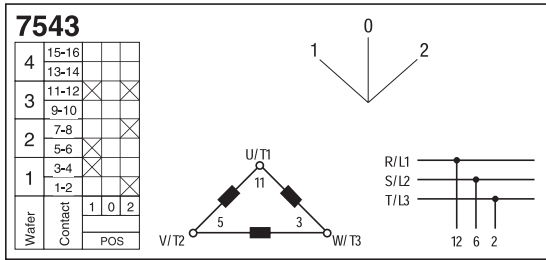
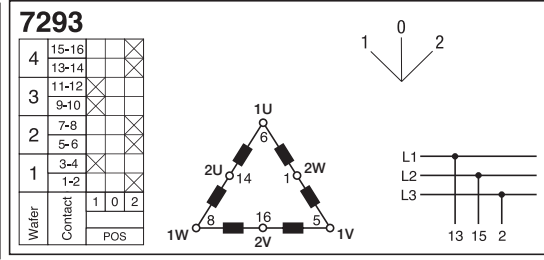
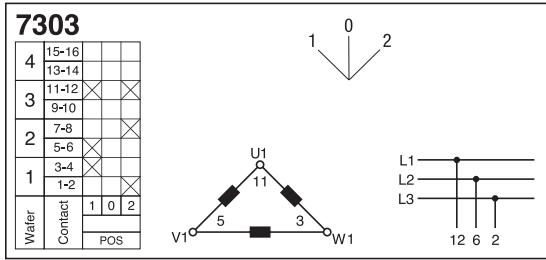

**K** L2 Rotary Cam Switches



*Fax completed form to:  
In USA 800-739-7370 or in Canada 905-475-0027*

**USE ONE FORM FOR EACH NAME PLATE ORDERED**

**Customer Information:**

Today's Date: \_\_\_\_\_ Order Form \_\_\_\_\_ of \_\_\_\_\_

Name: \_\_\_\_\_

Company: \_\_\_\_\_

Address: \_\_\_\_\_

City: \_\_\_\_\_ State: \_\_\_\_\_ Zip: \_\_\_\_\_

Telephone: \_\_\_\_\_

Job Reference/PO #: \_\_\_\_\_

**Quantity required exactly like this one:** \_\_\_\_\_

For Compatibility Verification please include the following:

Catalog Number of Switch to be used on

L			-			-				
---	--	--	---	--	--	---	--	--	--	--

Switch Handle Assembly to be used with

L			-			-				
---	--	--	---	--	--	---	--	--	--	--

**NOTE:** Types "N" and "G" are not available with custom markings.

**Ordering Instructions:**

- 1) For reference only, enter the switch and handle assembly part numbers in the spaces to the right.
- 2) Based on your selection switch angle rotation, define the appropriate template figure and check mark the angle rotation (30/60/45/90°)
- 3) Enter the desired text in the spaces provides. Text limitation is defined by the amount of " \_ " underlines provided per angle.
- 4) Use a new order form for each different custom nameplate.

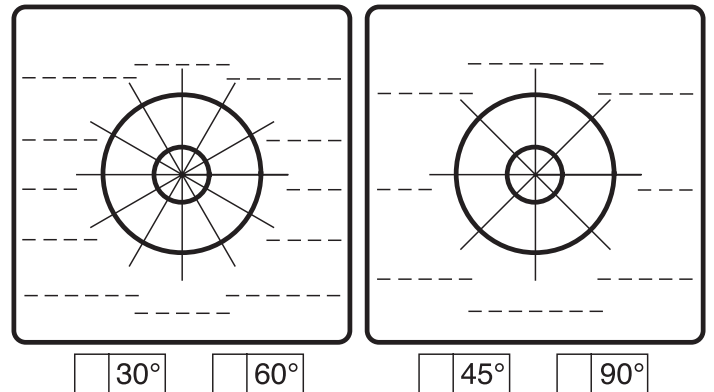

SS-99-220-302  
06/26/2016 CAS

### Technical Information

UL/CSA			L2-12	L2-16	L2-20	L2-25	
<b>General use</b>							
1-phase/2-phase, 3-phase/3 poles	Rated current	600 V	12	16	20	25	
Heavy Pilot Duty	code designation	AC	A600	A600	~	~	
Standard Duty	code designation	DC	~	~	~	~	
<b>Alternating Current (IEC / EN 60947-3)</b>							
Rated Voltage $U_e$	IEC-EN / UL-CSA	(V)	690/600	690/600	690/600	690/600	
Rated Isolation Voltage $U_i$	IEC / UL-CSA	(V)	690/600	690/600	690/600	690/600	
Rated impulse voltage $U_{imp}$	IEC	(kV)	6	6	6	6	
Test voltage $U_i$ 1 min.		(kV)	2.5	2.5	2.5	2.5	
Rated frequency		(Hz)	50/60	50/60	50/60	50/60	
Thermal rated current $I_{th}$ open 40°C		(A)	16	20	25	30	
Thermal rated current $I_{the}$ enclosed 60°C		(A)	12	16	20	25	
Wasted power by 1 pole at thermal rated current $I_{the}$		(W)	0.3	0.5	0.6	0.9	
<b>Rated Operating Current <math>I_e</math></b>							
AC-1/ AC21A	Switching resistive loads with slight overload	IEC947 690V	(A)	12	16	20	25
AC-1	Non-inductive or slightly inductive loads inductive loads	SEV 690V	(A)	12	16	20	25
AC-22A	Switching mixed resistive and inductive loads at slight overload	IEC947					
		220-500V	(A)	12	16	20	25
		600V	(A)	12	16	20	25
AC-15	Switching magnetic drives, motors, valves and solenoids	IEC 220-240V	(A)	5	6	7	8
		380-415V	(A)	3	4	5	6
		500V	(A)	2	2.5	3	4
<b>Pilot Duty</b>							
Rated current	Non-inductive or slightly inductive loads	UL/CSA – Heavy VAC UL/CSA ①	(A)	A600 12	A600 16	— 20	— 25
<b>Short Circuit Current</b>							
	Max. fuse rating of circuit	(gL characteristic)	(A)	35	35	60	80
	Rated conditional		(kA)	5	5	5	5
<b>Rated Operating Powers</b>							
AC-2	Slip ring motors, starting induction motors, reversing and plugging, wye-delta starting	IEC/VDE/BS					
		240V	(kW)	3	4	5.5	5.5
		380V	(kW)	5.5	7.5	9	13
		3Ø 415V	(kW)	5.5	7.5	9	13
		3 pole 440V	(kW)	5.5	7.5	9	13
		500V	(kW)	7.5	10	11	15
		660V	(kW)	7.5	10	11	15
AC-3	Starting squirrel-cage motors, interruption while running	3Ø 220-240V	(kW)	2.2	3	4.5	5.5
		3 pole 380-440V	(kW)	4	5.5	7.5	11
		500V	(kW)	5.5	7.5	10	13
		660V	(kW)	5.5	7.5	8	11
		1Ø 110V	(kW)	0.75	1.1	1.2	1.6
		2 pole 220-240V	(kW)	1.3	2.2	2.5	3.2
		380-440V	(kW)	2.2	3.7	4.5	5.5

① Suitable for switching off load (AC-20) above 660V, but only up to 660V for switches with screws at the rear (LE switches).

**Technical Information**

					L2-12	L2-16	L2-20	L2-25								
<b>Rated Operating Loads (cont.)</b> IEC/VDE/BS																
AC-4 Starting squirrel-cage motors, reversing, braking, plugging	3Ø	220-240V	(kW)		0.75	1.5	3	4								
	3 pole	380-415V	(kW)		1.5	2.2	3.7	5.5								
		440-550V	(kW)		1.5	2.2	3.7	5.5								
		660V	(kW)		—	—	—	—								
AC-23A Periodic switching of motors or other highly inductive loads.	3Ø	220-240V	(kW)		2.2	3	4.5	5.5								
	3 pole	380-440V	(kW)		4	5.5	7.5	11								
		500V	(kW)		5.5	7.5	10	13								
		660V	(kW)		5.5	7.5	8	11								
	1Ø	110V	(kW)		0.75	1.1	1.2	1.6								
	2 pole	220-240V	(kW)		1.3	2.2	2.5	3.2								
		380-440V	(kW)		2.2	3.7	4.5	5.5								
<b>Rated Power</b> UL/CSA					(FLA)	(FLA)	(FLA)	(FLA)								
Normal motor load full voltage rating (similar to AC-3)	3Ø	120V	(HP)		1 (7.2)	1.5 (12.0)	2 (13.6)	3 (19.2)								
		240V	(HP)		2 (6.8)	3 (9.6)	4 (12.4)	6 (18.0)								
	3 pole	480V	(HP)		5 (7.6)	7.5 (11.0)	8 (11.6)	12 (17.0)								
		600V	(HP)		5 (6.1)	7.5 (9.0)	10 (11.0)	15 (17.0)								
	1Ø	120V	(HP)		0.5 (9.8)	0.75 (13.8)	1 (16)	1.5 (20.0)								
	2 pole	240V	(HP)		1 (8.0)	1.5 (10.0)	2 (12)	3 (17.0)								
<b>DC Switch Ratings</b>					Contacts in Series											
					1	2	3	4	5	6	8					
<b>Rated Current <math>I_e</math></b>																
DC-21A For resistive loads $T \leq 1\text{ms}$ $U_{e\text{max}} = 600\text{V}$	Rated Voltage [V]	24	48	72	96	120	144	192	[A]	12	16	20	22			
		48	96	144	192	240	288	384	[A]	10	12	16	18			
		60	120	180	240	300	360	450	[A]	8	10	12	14			
		110	220	330	440	550	660	—	[A]	2	2.5	4	5			
		220	440	660	—	—	—	—	[A]	0.5	0.6	0.7	0.8			
		440	—	—	—	—	—	—	[A]	0.4	0.4	0.5	0.5			
<b>Rated Making/Breaking Capacity</b> ( $=1.5 \times I_e$ ) 1.05 x rated voltage [V]					25.2	50.4	75.6	100.8	126	151.2	201.6	[A]	18	24	30	33
					50.4	100.8	151.2	201.6	252	302.4	403.2	[A]	15	21	24	27
For resistive loads $T \leq 1\text{ms}$ $U_{e\text{max}} = 600\text{V}$	Rated voltage [V]	63	126	189	252	315	378	504	[A]	12	18	18	21			
		115.5	231	346.5	462	577.5	—	—	[A]	3	4.5	6	7.5			
		231	462	—	—	—	—	—	[A]	0.75	1.12	1.05	1.2			
		462	—	—	—	—	—	—	[A]	0.52	0.78	0.47	0.75			
<b>Rated Current <math>I_e</math></b>																
For inductive loads $T = 50\text{ms}$ $U_{e\text{max}} = 600\text{V}$	Rated voltage [V]	24	48	72	96	120	144	192	[A]	8	10	12	14			
		30	60	90	120	150	180	240	[A]	4.5	5.5	7	8			
		48	96	144	192	240	288	384	[A]	1.5	2	2.5	3			
		60	120	180	240	300	360	450	[A]	1	1.2	1.5	1.8			
		110	220	330	440	550	660	—	[A]	0.4	0.5	0.6	0.7			
		<b>Rated Making/Breaking Capacity</b> ( $=1.1 \times I_e$ ) 1.1 x rated voltage [V]					26.4	52.8	79.2	105.6	132	158.4	184.8	[A]	8.8	11
					33	66	99	132	165	198	231	[A]	4.95	6.05	7.7	8.8
For inductive loads $T = 50\text{ms}$ $U_{e\text{max}} = 600\text{V}$	Rated voltage [V]	52.8	105.6	158.4	211.2	264	316.8	369.6	[A]	1.65	2.2	2.75	3.3			
		66	132	198	264	330	396	462	[A]	1.1	1.32	1.65	1.98			
		121	242	363	484	605	—	—	[A]	4.95	6.05	7.7	8.8			
		<b>Rated Power <math>P_e</math></b>														
		DC-23A, DC-3, DC-5 For inductive loads $T \leq 1\text{ms}$	Rated voltage [V]	Contacts in Series				[kW]								
1					0.12	0.15	0.20	0.25								
2					0.20	0.25	0.30	0.37								
2					0.25	0.30	0.37	0.50								
3					0.30	0.37	0.50	0.75								
2					0.25	0.30	0.37	0.50								
4					0.37	0.50	0.75	1.00								
4					0.50	0.75	1.00	1.20								
6					1.00	1.20	1.40	1.60								
4					0.37	0.50	0.75	1.00								
6				1.00	1.20	1.40	1.50									

**K**  
L2 Rotary Cam Switches

### Technical Information

				L2-12	L2-16	L2-20	L2-25
<b>Rated Making/Breaking Capacity</b> (= 4 x I <sub>e</sub> )							
	1.05 x rated voltage [V]	Contacts in Series					
	25.2	1	[kW]	20.0	25.0	33.3	41.6
	25.2	2	[kW]	33.3	41.6	50.0	61.6
DC-23A, DC-3, DC-5	50.4	2	[kW]	21.0	25.0	30.8	41.6
For inductive loads T ≤ 7.5ms	50.4	3	[kW]	25.0	30.8	42.0	62.4
	63	2	[kW]	16.6	20.0	24.6	33.2
	63	4	[kW]	24.6	33.3	50.0	66.4
	115.5	4	[kW]	18.1	27.2	36.4	44.0
	115.5	6	[kW]	36.4	43.6	51.0	58.2
	231	4	[kW]	6.7	9.1	13.6	18.2
	231	6	[kW]	18.1	21.8	25.2	27.2
<b>Maximum Wire Gauges</b>							
	Rigid Wire		AWG	(2)18...12	(2)18...12	(2)16...10	(2)16...10
			[mm <sup>2</sup> ]	(2)1...2.5	(2)1...2.5	(2)1.5...6	(2)1.5...6
	Fine Strands		AWG	(2)18...12	(2)18...12	(2)16...10	(2)16...10
			[mm <sup>2</sup> ]	(2)1...2.5	(2)1...2.5	(2)1.5...4	(2)1.5...4
<b>Max. Torque Ratings</b>							
			[lb-in]	9	9	10.6	10.6
			[Nm]	1	1	1.2	1.2
<b>Protection Class</b>							
	Switch Handle Assembly						
	LFS2-UL		Type 12	Type 12	Type 12	Type 12	Type 12
	G(N)-6...						
	All others	IEC 529	IP66	IP66	IP66	IP66	IP66
	Switch Body	IEC 529	IP20	IP20	IP20	IP20	IP20
<b>Mechanical Life</b>							
	Millions of operations			1	1	1	1
<b>Rated Breaking Capacity</b>							
	220V	(A)		72	96	128	176
	Power factor			0.65	0.65	0.65	0.35
	380V	(A)		72	96	128	176
	Power factor			0.65	0.65	0.65	0.35
	660V	(A)		53	72	86	112
	Power factor			0.65	0.65	0.65	0.65
<b>Ambient Temperature</b>				(F°)	(F°)	(F°)	(F°)
	Operation	Min...Max	(C°)	-25...+60 (-13...+140)	-25...+60 (-13...+140)	-25...+60 (-13...+140)	-25...+60 (-13...+140)
	Storage only	Min...Max	(C°)	-40...+80 (-40...+176)	-40...+80 (-40...+176)	-40...+80 (-40...+176)	-40...+80 (-40...+176)
<b>Maximum Altitude (without derating)</b>				(m)	≤2000	≤2000	≤2000
				(ft.)	≤6561	≤6561	≤6561
<b>Maximum Mechanical Operations (without derating)</b>				(cycle/hr.)	1200	1200	1200
<b>Maximum Electrical Operation (without derating)</b>				(cycle/hr.)	120	120	120

**LE2 Panel Mount - Screw Fixing**

Dimensions are in millimeters (inches). Dimensions not intended for manufacturing purposes.

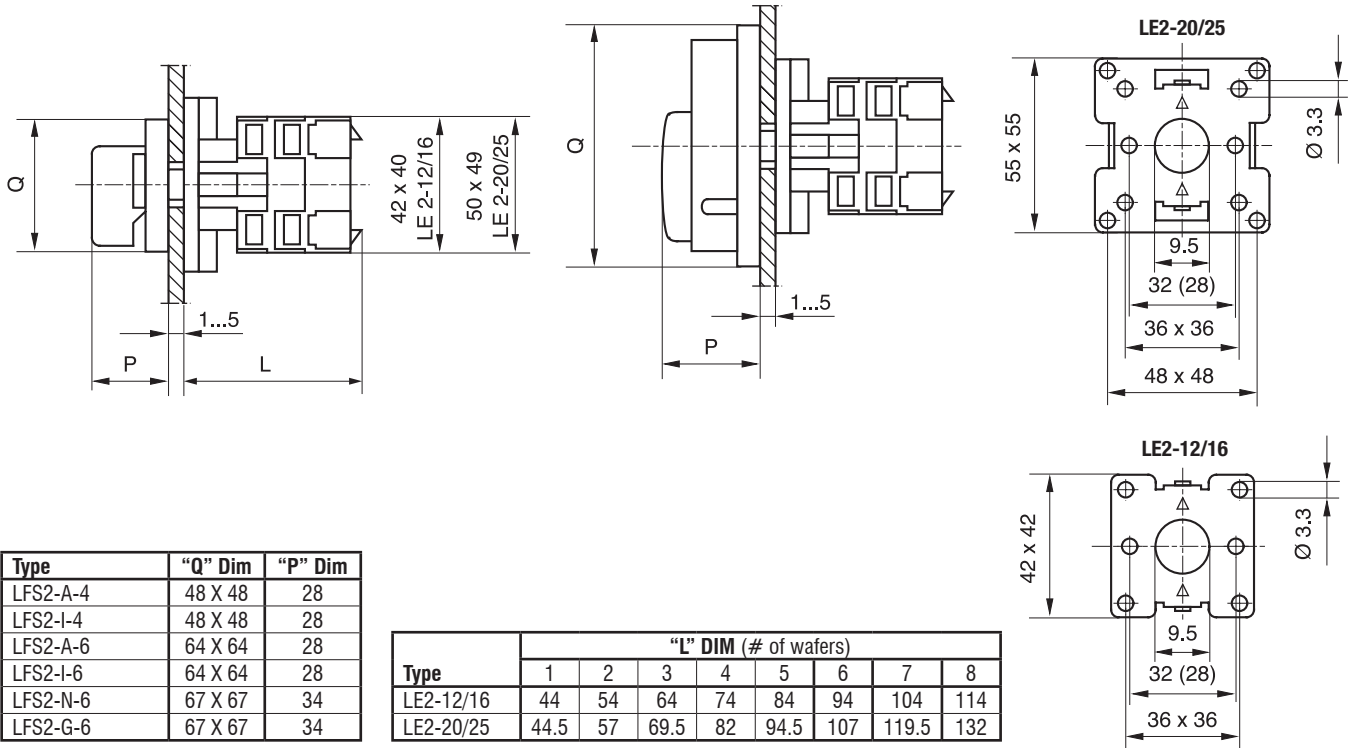

Type	"Q" Dim	"P" Dim
LFS2-A-4	48 X 48	28
LFS2-I-4	48 X 48	28
LFS2-A-6	64 X 64	28
LFS2-I-6	64 X 64	28
LFS2-N-6	67 X 67	34
LFS2-G-6	67 X 67	34

Type	"L" DIM (# of wafers)							
	1	2	3	4	5	6	7	8
LE2-12/16	44	54	64	74	84	94	104	114
LE2-20/25	44.5	57	69.5	82	94.5	107	119.5	132

**LE2 Panel Mount - Central Nut Fixing**

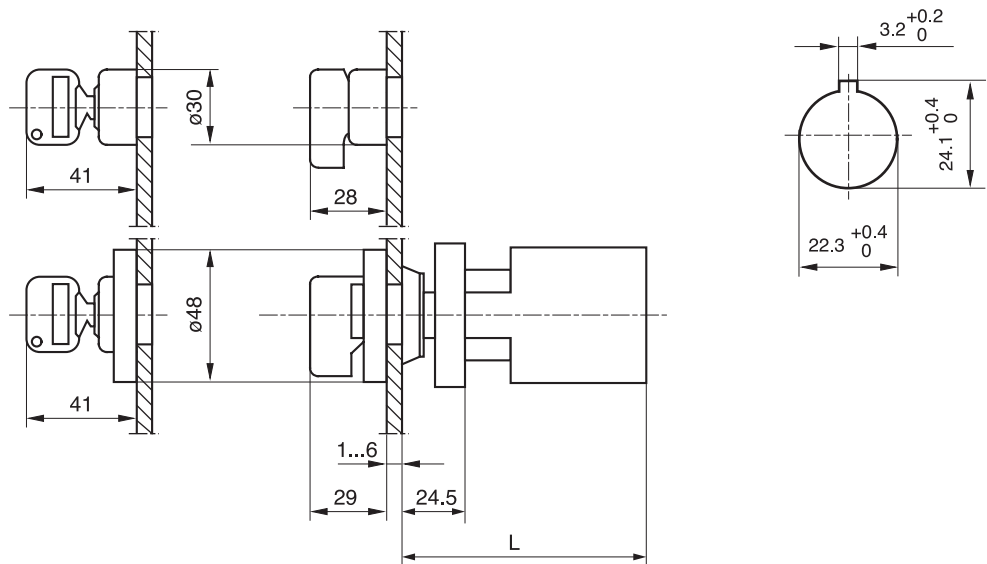

Type	"L" DIM (# of wafers)							
	1	2	3	4	5	6	7	8
LE2-12/16	67.5	77.5	87.5	97.5	107.5	117.5	127.5	137.5
LE2-20/25	69	81.5	94	106.5	119	131.5	144	156.5

#### LA2 Base Mount

Dimensions are in millimeters (inches). Dimensions not intended for manufacturing purposes.

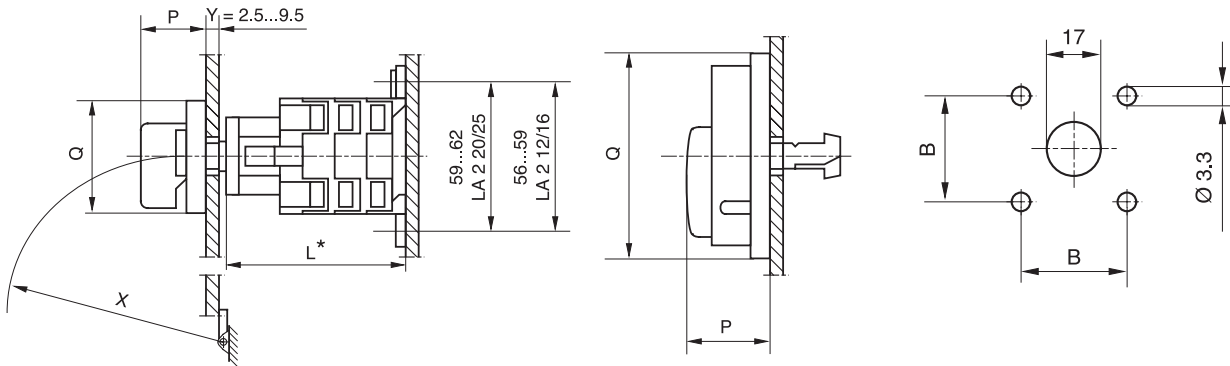

Type	"Q" Dim	"P" Dim	"B" Dim
LFS2-A-4	48 X 48	28	36
LFS2-I-4	48 X 48	28	36
LFS2-A-6	64 X 64	28	48
LFS2-I-6	64 X 64	28	48
LFS2-N-6	67 X 67	34	48
LFS2-G-6	67 X 67	34	48

Type	"L" DIM (# of wafers)			
	1	2	3	4
LA2-12/16	58	68	78	88
LA2-20/25	59	71.5	84	96.5

\* Add 2.5mm for DIN rail 46277.

#### LA2 Base Mount with Modular Shaft Extensions

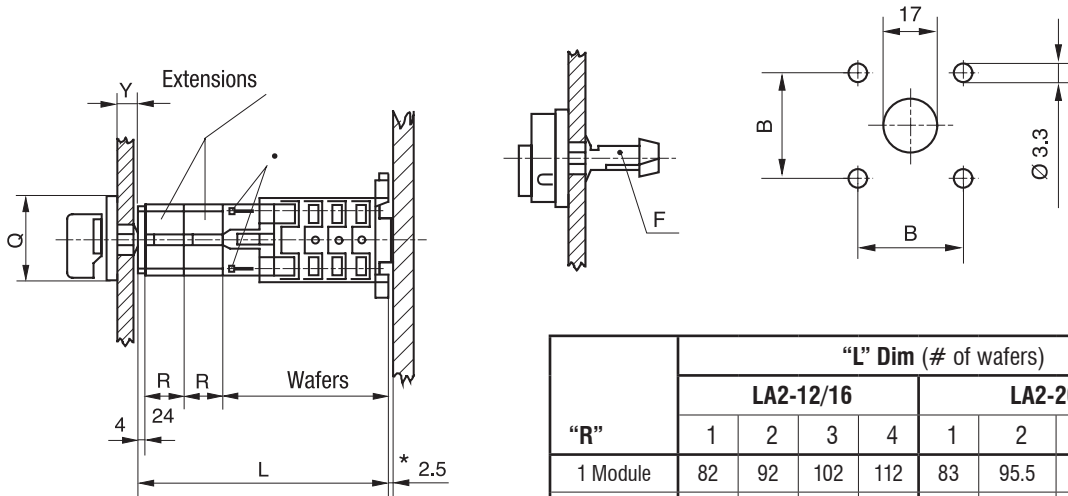

Type	"Q" Dim	"B" Dim
LFS2-A-4	48 X 48	36
LFS2-I-4	48 X 48	36
LFS2-A-6	64 X 64	48
LFS2-I-6	64 X 64	48
LFS2-N-6	67 X 67	48
LFS2-G-6	67 X 67	48

Shaft "F"	"Y" Dim
LA2-G2830	2.5-9.5
LA2-G3194	9 - 18
LA2-G3195	14 - 23

"R"	"L" Dim (# of wafers)							
	LA2-12/16				LA2-20/25			
	1	2	3	4	1	2	3	4
1 Module	82	92	102	112	83	95.5	108	120.5
2 Modules	106	116	126	136	107	119.5	132	144.5
3 Modules	130	140	150	160	131	143.5	156	168.5
4 Modules	154	164	174	184	155	167.5	180	192.5
5 Modules	178	188	198	208	179	191.5	204	216.5
6 Modules	202	212	222	232	203	215.5	228	240.5

\* Add 2.5mm for DIN rail 46277.

• With more than 4 modules attach the first one to the switch with the screws supplied with the LA2-G2853.

**LA2 Base Mount with Metal Shaft Extension**

Dimensions are in millimeters (inches). Dimensions not intended for manufacturing purposes.

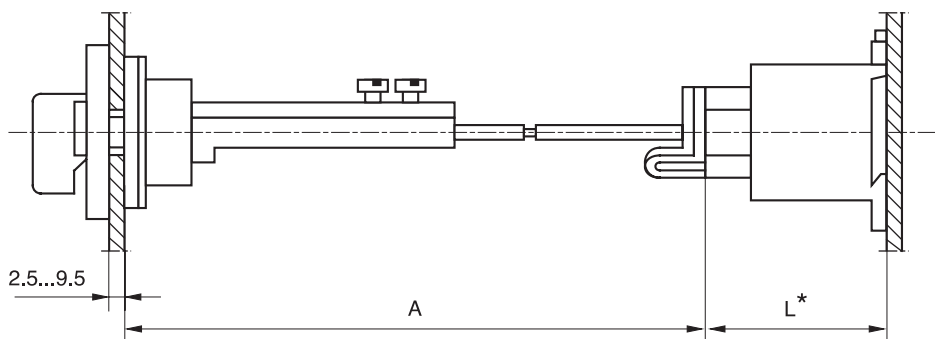

Type	"L" DIM (# of wafers)			
	1	2	3	4
LA2-12/16	54	64	74	84
LA2-20/25	55	67.5	80	92.5

Type	"A" Dim
LA2-G3393	110 - 235
LA2-G3394	230 - 350

\* Add 2.5mm for DIN rail 46277.

**LA2 Base Mount with LFS2-P-4**

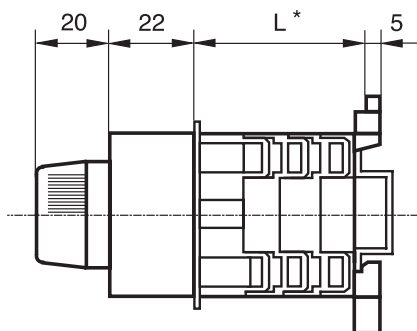

Type	"L" DIM (# of wafers)			
	1	2	3	4
LA2-12/16	35	45	55	65
LA2-20/25	35.5	48	60.5	73

\* Add 2.5mm for DIN rail 46277.

# R-Line Series 40 Amp Rotary Cam Switches

Rugged and dependable  
40 amp switches for  
industrial applications



Sprecher + Schuh's rugged R-Line rotary cam switches are available for most control and load applications up to 40 amps. A well thought out ordering system provides many standard and nonstandard configurations, that are often available "off the shelf." Many popular switching configurations are offered from stock.

## ...For many applications

R-Line control and load switches comply with the most important international standards for use as:

- **Changeover Switches** - for switching between alternate electrical supplies.
- **ON/OFF switches** - to connect and disconnect any electrical supply.
- **Multi-position load switches** - for the step control of loads such as heaters and furnaces.
- **Motor load disconnect switches** - for safely isolating circuits during repair and maintenance.
- **Reversing switches** - to change the direction or rotation of a motor.
- **Wye-Delta switches** - To manually control reduced voltage starting of a motor.

## Rugged quality

The R-Line's sturdy design incorporates a positive switching action with a clearly defined switch position. The contact assemblies themselves are brass plated and have generous copper content to help dissipate heat.

## Solid connections

The terminal connections are a captive screw design with self-lifting saddle clamps. The saddle clamp design guarantees reliable connections on the R-40. The switch connection terminals are finger safe with IP20 protection.

## Choose from various switch handle assemblies





















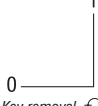

Switch handle assemblies for our Changeover and ON-OFF switches are available with either traditional screw fixing or central nut fixing system. All switch handles offer Type 12 IP66 protection. A UL 4X handle is also available, ordered separately.

K

R-Line Rotary Cam Switches





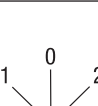

**R-Line Front Mounted 40 Amp Rotary Switches with Handle ①**

Switch Description				Catalog Number	Switch Body Description				Catalog Number
Switch Handle Type 12/ IP66 ③	Function ②	Switch Angle	Poles/Switch Wafers		Switch Handle Type 12/ IP66 ③	Function ②	Switch Angle	Poles/Switch Wafers	
<b>ON - OFF</b>					<b>Step</b>				
 <i>Screw Fixing</i>		90° 90° 90° 90° 90°	1 / 1 2 / 1 3 / 2 4 / 2 6 / 3	RE-40-1751-A RE-40-1752-A RE-40-1753-A RE-40-1754-A RE-40-1756-A	 <i>Screw Fixing</i>		45°	1 / 2	RE-40-5261-A
 <i>Screw Fixing</i>		90° 90° 90°	3 / 2 4 / 2 6 / 3	RE-40-1753-N RE-40-1754-N RE-40-1756-N	<b>Reversing</b>				
 <i>Central Nut Fixing</i>		90° 90° 90° 90°	2 / 1 3 / 2 4 / 2 6 / 3	RC-40-1752-B RC-40-1753-B RC-40-1754-B RC-40-1756-B	 <i>Screw Fixing</i>		45°	3 / 3	RE-40-7303-A
 <i>Central Nut Fixing</i>		90° 90° 90° 90°	2 / 1 3 / 2 4 / 2 6 / 3	RC-40-1752-DD RC-40-1753-DD RC-40-1754-DD RC-40-1756-DD	<b>Wye-Delta</b>				
 <i>Central Nut Fixing</i>		90° 90° 90° 90°	2 / 1 3 / 2 4 / 2 6 / 3	RC-40-1752-DD RC-40-1753-DD RC-40-1754-DD RC-40-1756-DD	 <i>Screw Fixing</i>		45°/90°	3 / 4	RE-40-7323-A
<b>Changeover</b>					<b>Single Winding (Two Speed)</b>				
 <i>Screw Fixing</i>		45° 45° 45° 45°	1 / 1 2 / 2 3 / 3 4 / 4	RE-40-3251-A RE-40-3252-A RE-40-3253-A RE-40-3254-A	 <i>Screw Fixing</i>		45°	3 / 4	RE-40-7293-A
 <i>Screw Fixing</i>		45° 45°	3 / 3 4 / 4	RC-40-3253-B RC-40-3254-B					
 <i>Central Nut Fixing</i>		45° 45°	3 / 3 4 / 4	RC-40-3253-DC RC-40-3254-DC					

See **Ordering Instructions** on next page. ➡

- ① Rated current can be lower depending on application. Check R-Line Technical Section before selecting switch size.
- ② See K30 for Circuit Diagrams.
- ③ See page K8 for description of switch handles.

### R-Line Base Mounted 40 Amp Rotary Switches with Handle ❶

Switch Body Description				Catalog Number ❷
Switch Handle Type 12/ IP66 ❸	Function	Switch Angle	Poles/ Switch Wafers	
<b>ON-OFF</b>				
 Screw Fixing		90°	3 / 2	<b>RA-40-1753-A</b>
		90°	4 / 2	<b>RA-40-1754-A</b>
		90°	6 / 3	<b>RA-40-1756-A</b>
 Central Nut Fixing		90°	3 / 2	<b>RA-40-1753-N</b>
		90°	4 / 2	<b>RA-40-1754-N</b>
		90°	6 / 3	<b>RA-40-1756-N</b>

A UL Type 4X switch handle is available for RA-40 switches. First select switch from this page, then turn to Accessories Section (page K27) and order Type R switch handle separately.







### Ordering Instructions





RE-40 –		1753 –		A	
Switch Configuration	Circuit Diagram # ❷	Handle Code ❸	for use with		
<b>RE</b> - Front (Panel) Mounted 40 amp switch	<b>1751-1756</b> ON-OFF	<b>A</b> - Type A	RE/RA switch		
<b>RA</b> - Base Mounted 40 amp switch	<b>3251-3504</b> Changeover	<b>B</b> - Type B ❹	RC switch		
	<b>5261</b> Step	<b>N</b> - Type N	RE/RA switch		
	<b>7293</b> Single Winding	<b>DC</b> - Type DC ❹	RC switch		
<b>RC</b> - Front (Panel) mounted Central Nut fixing	<b>7303</b> Reversing	<b>DD</b> - Type DD ❹	RC switch		
	<b>7323</b> Wye-Delta				

Catalog numbers include a complete switch and handle kit.

- ❶ Rated current can be lower depending on application. Check R-Line Technical Section before selecting switch size.
- ❷ See K30 for Circuit Diagrams.
- ❸ See page K8 for description of switch handles.
- ❹ Not available on RA-40 Base Mounted switches.

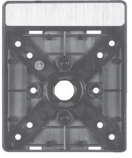
**R-Line Switch Accessories**

Accessory	Description	Catalog No.
 (Reducer not included)	<b>Replacement Shaft for RE switch</b> (One supplied with each LE switch)	L2-G3380
	<b>Standard knob</b> 37.5 mm Black Red 48 mm Black Red	L2-G3154N L2-G3154R  L2-G3155N L2-G3155R
	<b>Padlockable knob</b> Black Red	L2-G2864N L2-G2864R
	<b>Self-contained knob</b> allows mounting RE-40 switches without Switch Handle Assembly IP40 protection IP65 protection	L2-G2851N L2-G2854N
 LFS2-N	<b>"ON-OFF" Switch Handle Assembly</b> Type 12, IP66, accepts 3 padlocks Yellow and Red Gray and black	LFS2-N-6-175 LFS2-G-6-175
	<b>Type R "ON-OFF" Switch Handle Assembly ①②</b> Screw fixing. Type 3R, 3, 12, 4, 4X, and IP66 Black and Black Yellow and Red	LA7-SB LA7-SY
	<b>Type R "ON-OFF" Switch Handle Assembly ①②</b> Screw fixing. Type 3R, 3, 12, 4, 4X, and IP66 Black and Black Yellow and Red	L11-PB L11-PY

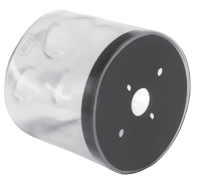
Accessory	Description	Catalog No.
	<b>Front frame</b> (blank nameplate)	L2-G3196
	<b>Legend plate - blank for engraving</b> Silver Yellow	LL2-A-6-000 LL2-I-6-000
	<b>Legend plate - 0 - I, 90°</b> Yellow	LL2-I-6-175
	<b>Terminal cover - 3 or 4 pole</b> For RA-40 For RE-40	RA-40-C4 RE-40-C4
	<b>Dust Cover</b> (not IP rated) FOR RE-40 1 or 2 switch wafers 3 or 4 switch wafers 5 or 6 switch wafers	RE-G3180 RE-G3181 RE-G3182

**K**

R-Line Rotary Cam Switches

① Switch handle can be field modified to be defeatable or non-defeatable.  
② Handles LA7-S\_ and L11-P\_ require R-type Switch Handle Shaft Extension. See page L13.

## Modular Shaft Extension system ①

Shaft Extension Modules are ideal for lengthening the shaft of an RA-40 switch up to 144mm (≈5.5"). These rugged polycarbonate modules are 24mm (≈15/16") long and snap on "piggyback" to one another without the use of tools. Strong center shafts interlock as each module is snapped together. The standard 44mm end shaft supplied with every RA-40 switch connects the last Extension Module to the Switch Handle Assembly. End shafts of 52 and 57mm are also available, making this modular system versatile, fast and economical. Shaft Extension Modules are supplied two per package.

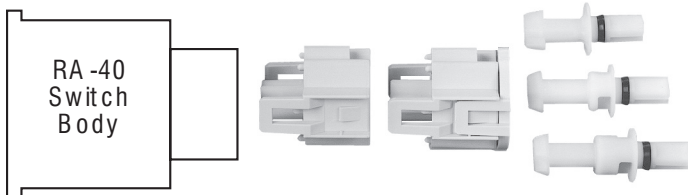

### Determining modular shaft extension components

- Determine mounting depth. This is the distance from the inside mounting surface of the enclosure to the **outside surface** of the enclosure cover. See diagram below for details.

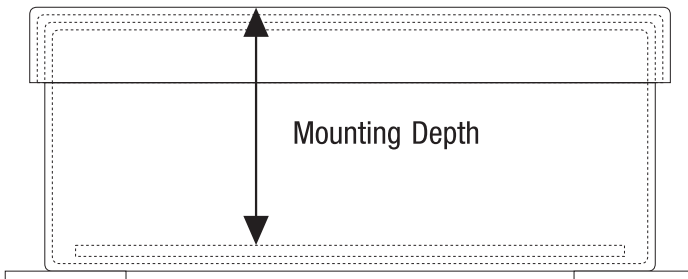



- If necessary, convert mounting depth inches to millimeters (inches x 25.4 = millimeters).
- In the Modular Shaft Extension Table to the right, find the correct range for your enclosure in the Mounting Depth column.

**NOTE:** Table is based on an RA-40 switch body with two wafers (3 or 4 pole). For a switch body with more or less wafers, add or subtract the following from overall Mounting Depth before referring to table:

RA-40 Switch Body - ±17.5mm per wafer

- Order the End Shaft and number of Extension Modules required for that mounting depth.

## Modular Shaft Extension Components (RA40 Base Mount)

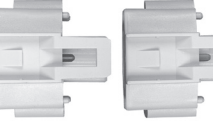
Component	Catalog Number
<b>44mm End Shaft</b> (supplied with RA-40 Switch Body Assembly) 	LA2-G2830
<b>52mm End Shaft</b> 	LA2-G3194
<b>57mm End Shaft</b> 	LA2-G3195
<b>Extension Module</b> (two per pkg - priced per pkg) 	LA2-G2853

## Modular Shaft Extension Table

Number of Extension Modules	Required End Shaft	Mounting Depth (mm)
		Switch Body RA-40
0	44mm ②	98.5 - 104.5
0	52mm	100.5 - 114
0	57mm	109 - 119
1	44mm ②	122.5 - 128.5
1	52mm	124.5 - 138
1	57mm	133 - 143
2	44mm ②	146.5 - 152.5
2	52mm	148.5 - 162
2	57mm	157 - 167
3	44mm ②	170.5 - 176.5
3	52mm	172.5 - 186
3	57mm	181 - 191
4	44mm ②	194.5 - 200.5
4	52mm	196.5 - 210
4	57mm	205 - 215

① For Type R (4X) switch handle shaft extensions, see "Type R Switch Handle Extension" table on page K29.

② One 44mm End Shaft is supplied with all Switch Body Assemblies.

## Metal shaft extension system ❶

Adjustable metal shaft extensions snap on securely to RA-40 switches via the same quick-connect design as shaft extension modules. Metal shafts are equipped with a door interlock and a padlock hasp for locking out the switch after the enclosure is opened (for outside lockout, select a Switch Handle with lockout capability).



Two standard lengths of these unique adjustable shafts are available. Metal shaft extensions mate with any of the standard Switch Handles. All necessary hardware is supplied with the shaft.

### Determining metal shaft extension

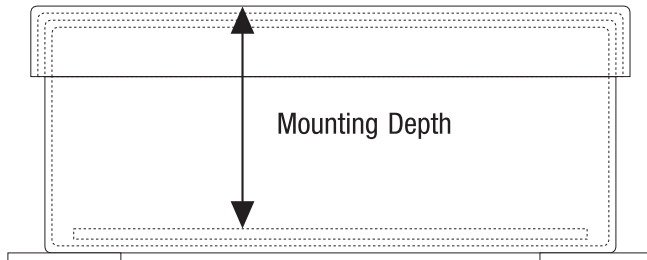

- Determine Mounting Depth. This is the distance from the inside mounting surface of the enclosure to the **outside surface** of the enclosure cover. See diagram below for details.



- If necessary convert Mounting Depth inches to millimeters (inches x 25.4 = millimeters).
  - In the appropriate table to the right, find the correct range for your enclosure in the Mounting Depth column.
- NOTE:** Tables are based on an RA-40 switch body with two wafers (3 or 4 pole). For a switch body with more or less wafers, add or subtract the following from overall Mounting Depth before referring to table:
- RA-40 Switch Body- ±17.5mm per wafer
- Order the Metal Shaft Extension required for that Mounting Depth and switch handle.

- ❶ Not for Type R (UL 4X) switch handles. Use Type R Switch Handle Extension table on this page.
- ❷ This dimension can be reduced by another 55mm by cutting the plastic sleeve and further cutting the metal shaft.
- ❸ Shaft included in package is designed for LA7-S\_ and L11-P\_ only. Not designed for use with previous L10-H\_ handles.

## Metal Shaft Extension Components (RA40 Base Mount)

Component	Catalog Number
<p><b>Short Metal Shaft</b></p>  <p>Length: 10 . . . 235mm (4-21/64...9-1/4 in.)</p>	LA2-G3393
<p><b>Long Metal Shaft</b></p>  <p>Length: 230 . . . 350mm (9-3/64...13-51/64 in.)</p>	LA2-G3394

### Metal Shaft Extension Table

Metal Shaft Extension	Mounting Depth (mm)
	Switch Body RA-40
LA2-G3393	205 ⌀ - 336
LA2-G3394	325 - 451

## Type R Switch Handle Shaft Extensions ❸

Only select shaft extension from this table if ordering the Type R (UL Type 4X) Switch Handle from the Accessories Section (page K27). Select shaft after figuring overall Mounting Depth.

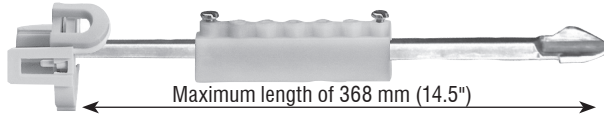
Type R Switch Handle Shaft Extension (typical)		
		
Mounting Depth (mm)	Catalog Number	
Switch Body RA-40		
119 - 143	LA7-S-67	See Page L13
142 - 166	LA7-S-90	
149 - 173	LA7-S-97	
167 - 191	LA7-S-115	
Adjustable R-type Switch Handle Shaft Extension (LA7-S1-P shown)		
		
119 - 191	LA7-S1-P	See Page L13
Includes all parts except L11-S1 shaft, order separately	LA7-NS-P	

**K**  
R-Line Rotary Cam Switches

### Circuit Diagrams

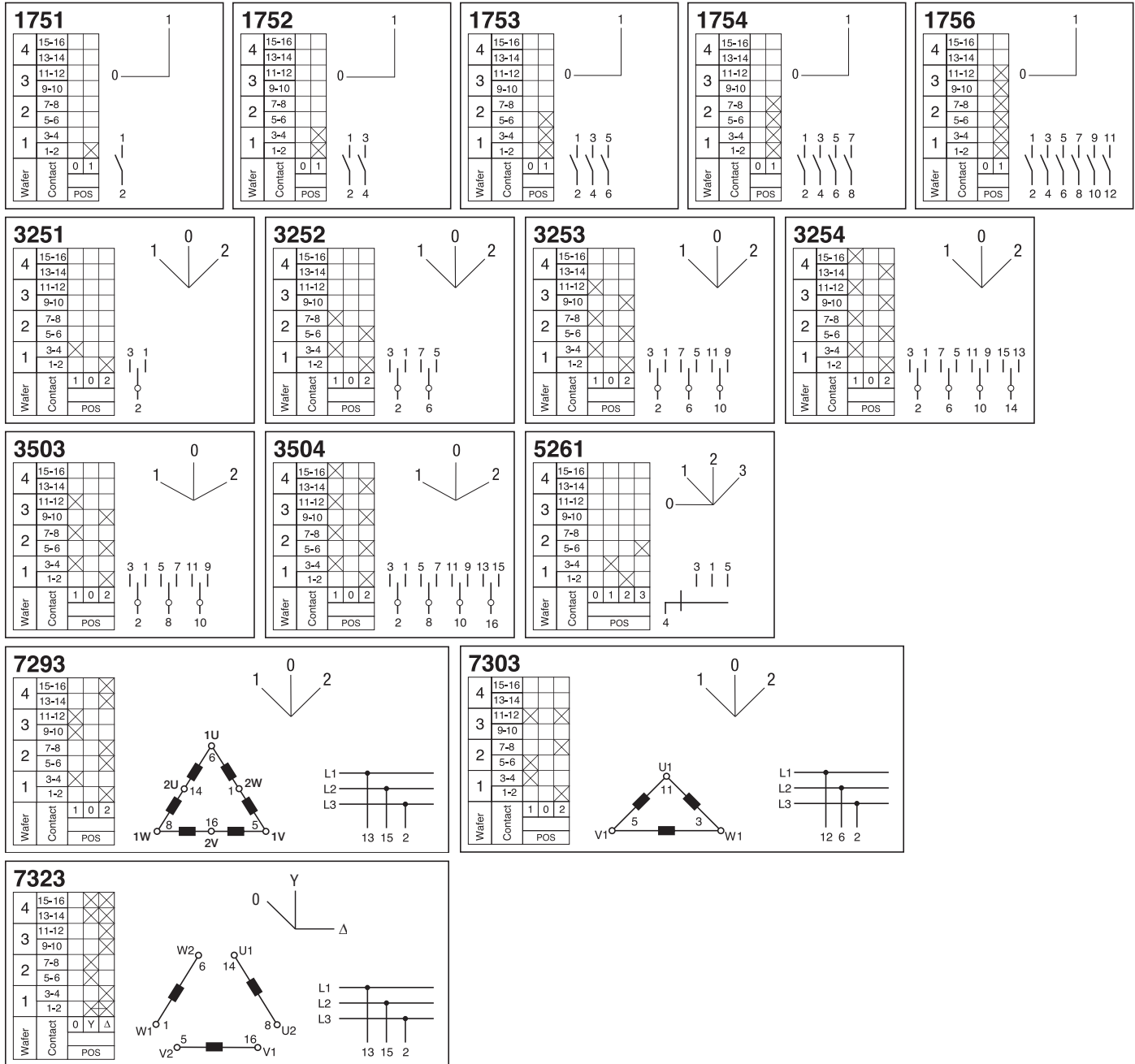

### Technical Information

				<b>R-40</b>		
<b>Rated Operating Voltage</b>	UL/CSA	[V]	600			
	IEC/VDE/BS	[V]	690			
<b>Rated Isolation Voltage</b>						
Impulse		[V]	8			
Continuous			690			
<b>Rated Thermal Current <math>I_{th}</math></b>	UL/CSA	[A]	40			
	IEC/VDE/BS	[A]	45			
<b>Rated Thermal Current <math>I_{the}</math></b>	IEC/VDE/BS	[A]	45			
<b>Rated Operating Current <math>I_e</math></b>						
AC-1/ AC21A	Switching resistive loads with slight overload	IEC947	690V	[A]	40	
AC-22A	Switching mixed resistive and inductive loads at slight overload	IEC947	220-500V 600V	[A]	40	
<b>Short Circuit Current</b>						
	Rated conditional (note type & fuse size)			[kA]	5	
	Maximum fuse rating of circuit, non-enclosed UL fuse type			[A]	40 Class J	
<b>Rated Operating Powers <math>P_e</math> ①</b>						
AC-3	Squirrel-cage motors: starting and stopping of running motors	3Ø 3 pole	230V	[kW]	7.5	
			400V	[kW]	18.5	
			690V	[kW]	18.5	
AC-4	Starting squirrel-cage motor starting, reversing, electric braking, inching	3Ø 3 pole	230V	[kW]	5.5	
			400V	[kW]	7.5	
			500V	[kW]	11	
AC-23A	Periodic switching of motors or other highly inductive loads.	3Ø 3 pole	230V	[kW]	11	
			400V	[kW]	11	
			690V	[kW]	22	
<b>Rated Power</b>						
Across the line AC motor starting DOL-rating		UL/CSA	120V	[HP]	5	
			240V	[HP]	10	
			480V	[HP]	25	
			600V	[HP]	25	
		General use	600VAC	1Ø	[HP]	2
				2 pole	[HP]	5
				480V	[HP]	10
				600V	[HP]	15
<b>Rated Breaking Capacity</b>	690V	[A]	196			
	Power factor		0.45			
<b>DC-20 Switching</b>						
Rated operating current $I_e$		[A]	40			
<b>DC-1 Switching</b>						
<b>DC-21A Switching</b>						
Rated operating current $I_e$		[A]	25			
	V max pole	[V]	60			
<b>DC-23 Switching</b>						
Rated power	24VDC	[kW]	0.3 (1)			
(the numbers in brackets indicate the number of poles that must be connected in series)	48VDC	[kW]	0.5 (2)			
	60VDC	[kW]	1 (2)			
	110VDC	[kW]	2 (3)			
	220VDC	[kW]	2.2 (5)			

				<b>R-40</b>	
<b>DC-13 Switching</b> L/R = 40ms	24VDC	[A]	16		
	48VDC	[A]	8		
	60VDC	[A]	4.8		
	110VDC	[A]	2		
	220VDC	[A]	0.6		
	380VDC 500VDC	[A]	0.4 0.3		
<b>Maximum Wire Gauges</b>					
Single/multi-core wire	(1 wire)	[mm²]	10/6		
		[AWG]	8/10		
Single/multi-core wire	(2 wires)	[mm²]	10/10		
		[AWG]	8/10		
<b>Minimum Wire Gauges</b>					
Single/multi-core wire	(1 wire)	[mm²]	4/2.5		
		[AWG]	12/14		
<b>Terminals</b>					
Terminal Type				Screw M4	
<b>Protection Class</b>					
Switch Handle Assembly					
LFS2-G(N)-6...	UL / IEC 529		Type 12 / IP66		
LA7-SB/SY	UL		4/4X		
LFS(C)2-...4(6, 8, 13)...	UL / IEC 529		Type 12 / IP66		
Switch Body	IEC 529		IP20		
<b>Mechanical Life</b>					
		[Millions of ops.]	1		
<b>Maximum Mechanical Operations (without derating)</b>					
		[cycle/hr.]	1200		
<b>Maximum Electrical Operation (without derating)</b>					
		[cycle/hr.]	120		
<b>Ambient Temperature</b>					
Operation	Min...Max	[C°]	-25...+60		
Storage only	Min...Max	[C°]	-40...+80		
<b>Maximum Altitude (without derating)</b>					
		[m]	≤2000		
		[ft.]	≤6561		

### Approvals



① Values approved by IMQ

**RE-40 Panel Mounting**

Dimensions are in millimeters (inches). Dimensions not intended for manufacturing purposes.

**Type G/N**

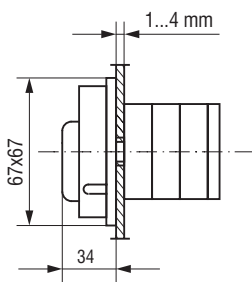

**Type A**

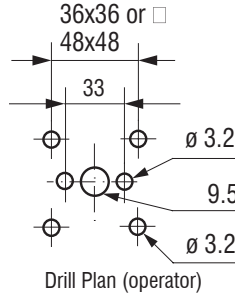
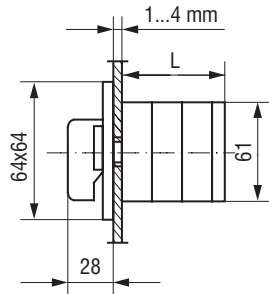

**Screw Fixing (RE-40)**

Type	"L" Dim (# of wafers)			
	1	2	3	4
RE-40	41	58.5	76	93.5

**Type D (RC-40)**

**Type B (RC-40)**

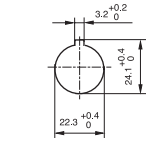
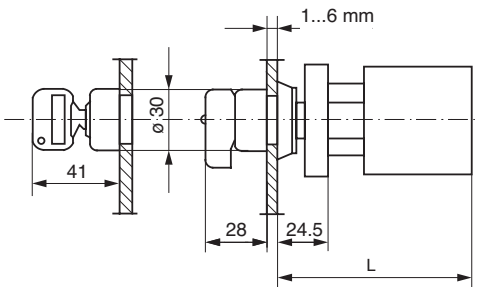

Drill Plan (operator)

**Central Fixing (RC-40)**

Type	"L" Dim (# of wafers)							
	1	2	3	4	5	6	7	8
RC-40	86	103.5	121	138.5	156	173.5	191	208.5

**RA-40 Base Mounting**

**Type G/N**

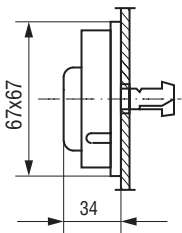

**Type A**

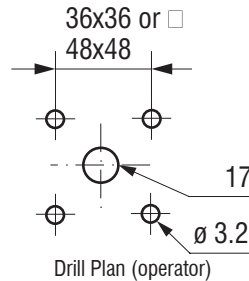
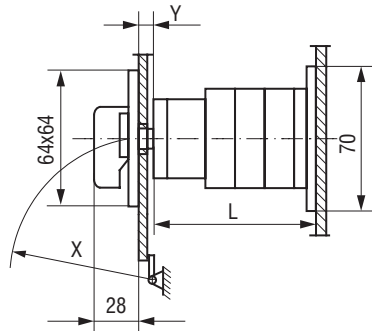

Drill Plan (operator)

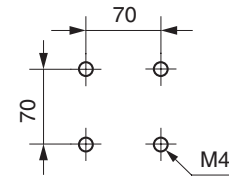

Drill Plan (base)

Type	"L" Dim (# of wafers)			
	1	2	3	4
RA-40	42.5	60	77.5	95

For LA7-SB/SY Handle Dimensions see page L22  
 For L11-PB/PY Handle Dimensions see page L50



**RA-40 Base Mount with LA2-G339\_Metal Shaft Extension**

Dimensions are in millimeters (inches). Dimensions not intended for manufacturing purposes.

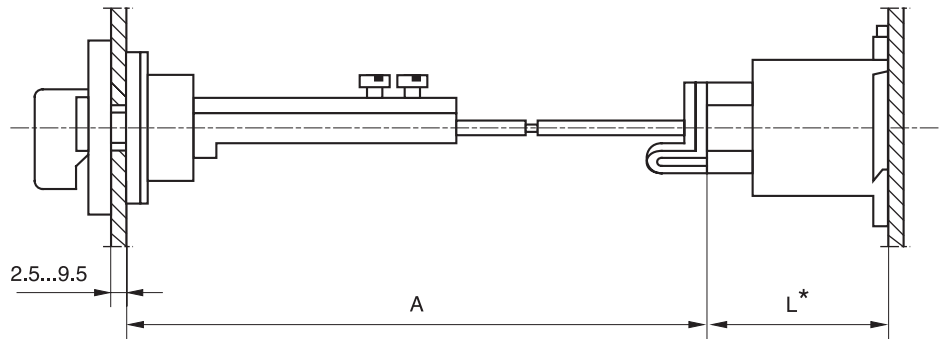

Type	"L" Dim (# of wafers)			
	1	2	3	4
RA-40	42.5	60	77.5	95

Type	"A" Dim
LA2-G3393	110 - 235
LA2-G3394	230 - 350

\* Add 2.5mm for DIN rail 46277.



**Notes**

---

---

---

---

---

---

---

---

---

---

---

---

---

---

---

---

---

---

---

---

---

---

---

*For Technical Information and Dimensions  
please see the online catalog*

**K**  
Rotary Cam Switches

**Notes**

*For Technical Information and Dimensions  
please see the online catalog*

**Notes**

*For Technical Information and Dimensions  
please see the online catalog*

**K**

*Rotary Cam Switches*

Notes

*For Technical Information and Dimensions  
please see the online catalog*