

Series V7-W Terminals

A comprehensive selection of rugged connections



Sprecher + Schuh's V7-W terminals are designed to meet the three most important criteria when selecting a terminal block line – ease of wiring, secure connections, and durability. The line is also comprehensive, offering a wide array of terminal types for most circuits and functions, from control to low level power.

The size you need

V7-W feed-through terminals come in ten sizes and are rated to 600VAC (800V-IEC). They accommodate a full range of wire sizes from 30AWG to 3/0 AWG (0.5mm² to 70mm² wire cross section). Many “specialty” feed-through terminals are also available that provide multiple terminations or increase the density of connections. This reduces panel space and saves money.

Comprehensive selection of special terminals

Aside from the broad selection of standard feed-through terminals, many special terminals are also part of the V7-W line, including:

- Two level terminals
- High Current terminals
- Ground terminals
- Dual connection terminals
- Diode terminals
- Plug-in style terminals
- Various isolating terminals
- Fuse terminals
- Sensor terminals
- Thermocouple terminals
- Proximity switch terminals

Even the most varied circuit requirements can be supported by the broad selection offered with this line.

Super reliable connections

The most important aspect of a terminal block is to join wires in a reliable connection. With V7-W terminals, a cone shaped guide allows easy insertion of the wire into a nickel plated barrel. As tightening torque is applied to

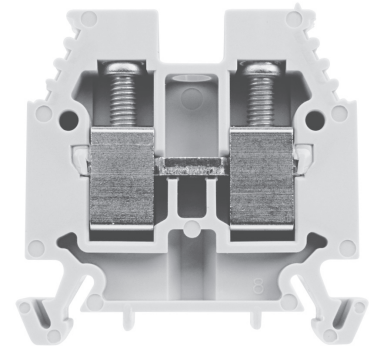

Stainless steel screws and nickel plated current bars provide a strong, corrosion resistant connection

strong stainless steel screws, the wire is secured between a recessed contact pad and serrated current bar. This corrosion-resistant clamping mechanism provides excellent performance in the most demanding industrial conditions.





Superior insulation and protection features

All metal parts are recessed, providing a touch-safe, dead front design for optimum safety. Terminal bodies are manufactured from Polyamide 6.6, known for its excellent thermal stability, impact resistance and resistance to electrical creepage. The insulating cases are rated up to 90°C (195°) for continuous operation. They also stay elastic down to -40°C (-40°F) without fracturing.



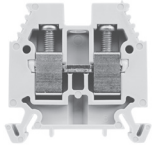
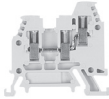

International approvals

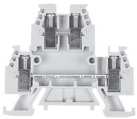
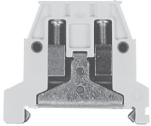
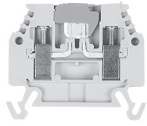
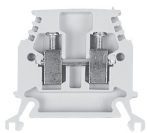
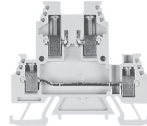
Sprecher + Schuh's V7-W terminal block line is UL recognized and CSA Certified. Many terminals have also been certified for use in hazardous locations. The line also carries the CE Mark for use in most international markets.

Quick Selection Guide (refer to page indicated for complete information and detailed pricing)

Terminal	Description	Type	Overall Term. Width	Cross-sec. [mm ²]	Catalog Number	See Page...		
Through Terminals								
	Standard Feed-Through Blocks Provides one straight-through circuit for wire sizes up to 70 mm ² .	Color: gray (other colors available)	5	2.5	V7-W3	N5		
			6	4	V7-W4	N5		
			7	6	V7-W6	N5		
			8	10	V7-W10	N6		
			11	16	V7-W16S	N6		
			14	35	V7-W35	N7		
			23	70	V7-W70	N7		
  	Specialty Feed-Through Blocks Provides one straight-through circuit with 3 wire terminals.	Color: gray (other colors available)	5	2.5	V7-W3TW	N9		
			Return Terminals Single circuit terminal block with terminals on common side.	Color: gray	5	2.5	V7-WR3	N9
					Two Level Terminals Color: gray	5	2.5	V7-WD3
6	4	V7-WD4	N8					
7	6	V7-WD6	N8					
Ground Terminals								
	Grounding Terminals Color: green / yellow	6	4	V7-WG4	N10			
		7	6	V7-WG6	N10			
		8	10	V7-WG10S	N10			
		13	16	V7-WG16	N11			
		18	35	V7-WG35	N11			
		22	70	V7-WG70	N11			
		6	2.5	V7-WDG4C	N12			
Isolation and Plug-in Style Blocks								
	Knife Style Isolation Blocks Used to isolate a circuit after power has been removed by an appropriate disconnect switch.	Color: gray	5	2.5	V7-WKD3	N16		
			5	2.5	V7-WKD3TP	N16		
			9	6	V7-WKD6	N16		
	Handle Style Isolation Block Used to isolate a circuit after power has been removed by an appropriate disconnect switch.	Color: black	9	4	V7-H7	N17		
			Plug-in Style Block Accepts plugs listed on opposite page.	without insert without insert, with test plug screws	6	2.5	V7-W4P	N20
6	2.5	V7-W4PTP			N20			
	Two & Three Level Plug-in Style Terminal Blocks - Accepts plugs listed on opposite page.	two level, without insert three level, without insert, with ground	6	2.5	V7-WD4P	N21		
			6	2.5	V7-WDG4P	N21		

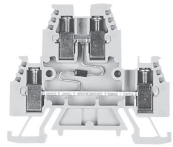
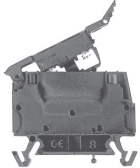
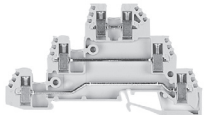
Quick Selection Guide (refer to page indicated for complete information and detailed pricing)

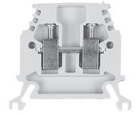
Terminal	Description	Type	Overall Term. Width	Cross-sec. [mm ²]	Catalog Number	See Page...
Isolation and Plug-in Style Blocks (continued)						
Inserts for V7-W4P— Order Separately						
	Disconnect Plug				V7-DP4	N28
	Component Plug				V7-CP4	N28
	Fuse Plug	5 x 20 mm; without indication 5 x 20 mm; with LED 5 x 20 mm; with LED			V7-FP4 V7-FP424 V7-FP4250	N28
Two Level Component Terminals						
	Diode Terminals	with a fixed connection with a diode in forward bias with a diode in reverse bias	6 6 6	4 4 4	V7-WD4C V7-WD4DF V7-WD4DR	N22
Fusible Terminals						
	Fuse Terminals (fuses not supplied)	5 x 20 mm, without indication 5 x 20 mm, without indication 5 x 20 mm, with LED 5 x 20 mm, with neon lamp 6.3 x 32 mm, without indication 6.3 x 32 mm, without indication 6.3 x 32 mm, with LED 6.3 x 32 mm, with neon lamp	8 8 8 8 9 9 9 9	4 4 4 4 4 4 4 4	V7-WFB4 V7-WFB10V V7-WFB424 V7-WFB4250 V7-H6 V7-WFB10VA V7-H5 V7-H4	N13 N15 N13 N13 N14 N15 N14 N14
Sensor Terminals						
	Sensor Supply Terminal (Initiator)	without LED with LED PNP with LED NPN	5 5 5	2.5 2.5 2.5	V7-WTF3 V7-WTF3LP V7-WTF3LN	N18 N18 N18
	Sensor Terminal (Initiator)	no indicator with LED PNP with LED NPN	5 5 5	2.5 2.5 2.5	V7-WTS3 V7-WTS3LP V7-WTS3LN	N19 N19 N19
Thermocouple Terminals						
	Thermocouple Terminals	Chromel / Constantan Iron / Constantan Copper / Constantan	10 10 10	2.5 2.5 2.5	V7-WTC3E V7-WTC3J V7-WTC3T	N23 N23 N23

N
V7 Terminals

Standard Feed-Through Blocks ①

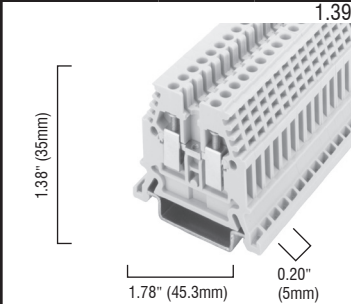
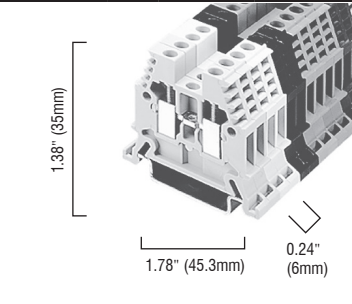
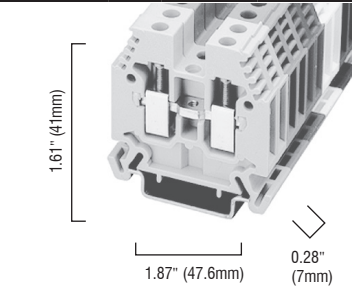
Ordering and Technical Information ①	2.5mm ²		4mm ²		6mm ²				
									
	Single circuit terminal block		Single circuit terminal block		Single circuit terminal block				
	Catalog Number	Pkg. Qty	Catalog Number	Pkg. Qty	Catalog Number	Pkg. Qty			
Terminal - Gray	V7-W3	50	V7-W4	50	V7-W6	50			
Red	V7-W3-RE	50	V7-W4-RE	50	V7-W6-RE	50			
Blue	V7-W3-B		V7-W4-B		V7-W6-B				
Black	V7-W3-BL		V7-W4-BL		V7-W6-BL				
Green	V7-W3-G		V7-W4-G		V7-W6-G				
Yellow	V7-W3-Y		V7-W4-Y		V7-W6-Y				
Orange	V7-W3-OR		V7-W4-OR		V7-W6-OR				
White	V7-W3-W		V7-W4-W		V7-W6-W				
Brown	V7-W3-BR		V7-W4-BR		V7-W6-BR				
Accessories (also see pages N24...N29)									
End Barrier	V7-EB3	50	V7-EB3	50	V7-EB10	50			
End Anchors									
DIN Rail — Normal Duty	V7-EA35	50	V7-EA35	50	V7-EA35	50			
DIN Rail — Heavy Duty	V7-EAH35	10	V7-EAH35	10	V7-EAH35	10			
DIN Rail — Snap-in	V7-ER35	50	V7-ER35	50	V7-ER35	50			
Jumpers									
Side Jumper – 10-pole Insulated	V7-SJ5-10	10	V7-SJ6-10	10	V7-CJ7-40 (40 pole)	5			
Center Jumper – 50-pole	V7-CJ5-50	5	V7-CJ6-50	5					
Center Jumper – 10-pole	V7-CJ5-10	10	V7-CJ6-10	10	V7-CJ7-10	10			
Center Jumper – 3-pole	V7-CJ5-3	10	V7-CJ6-3	10	V7-CJ7-3	10			
Center Jumper – 2-pole	V7-CJ5-2	10	V7-CJ6-2	10	V7-CJ7-2	10			
Center Jumper Link	V7-CJL5	10	V7-CJL6	10	V7-CJL7	10			
Center Jumper Cover – White	V7-CJCW5 ②	20	V7-CJCW6	20	V7-CJCW6	20			
Other Accessories									
Partition Plate	V7-PP3	50	V7-PP3	50	V7-PP10	50			
Separation Plate	V7-SP3	50	V7-SP3	50	V7-TP28	10			
Test Plug			V7-TP28	10					
Test Plug			V7-TP6E	10	V7-TA40	10			
Test Plug			V7-TP6EWL	10					
Test Plug Adapter	V7-TA285	10	V7-TA40	10					
Electrical Warning Plate (1-pole)	V7-EWP5-4	10	V7-EWP5-4	10	V7-EWP7-4	10			
Screwdriver ③	V7-SCRDRV1	1	V7-SCRDRV1	1	V7-SCRDRV1	1			
Marking Systems ④									
Blank Tags (cards of 100)	V7-SM5X9	5	V7-SM6X12	5	V7-SM6X12	5			
	V7-SM5X12	5		5					
Pre-printed Tags (sticks of 10)	V7-MP5 ⑤	10	V7-MP ⑤	10	V7-MP ⑤	10			
Terminal Block Specifications									
Approvals	UL	UL	IEC	UL	UL	IEC	UL	UL	IEC
Voltage Rating	600V AC/DC	600V AC/DC	800V AC/DC	600V AC/DC	600V AC/DC	800V AC/DC	600V AC/DC	600V AC/DC	800V AC/DC
Maximum Current	20 A	20 A	24 A	30 A	30 A	32 A	40 A	40 A	41 A
Wire Range (Rated Cross Section)	#22...#14 AWG	#30...#14 AWG	0.5...2.5mm ²	#22...#10 AWG	#22...#10 AWG	0.5... 4mm ²	#22...#10 AWG	#22...#10 AWG	0.5... 6mm ²
Wire Strip Length	0.39" (10 mm)			0.35" (9 mm)			0.47" (12 mm)		
Recommended Tightening Torque	5.0...5.6 lb-in. (0.6 Nm)			5.0...5.6 lb-in. (0.6 Nm)			5.6...6.8 lb-in. (0.7 Nm)		
Density	61 pcs./ft (200/m)			50 pcs./ft (166/m)			43 pcs./ft (142/m)		
Insulation Temperature Range	-40°...+195°F (-40°...+90°C)			-40°...+195°F (-40°...+90°C)			-40°...+195°F (-40°...+90°C)		
Mounting Rail	Fits all types shown on page N30			Fits all types shown on page N30			Fits all types shown on page N30		

① Special order with minimum quantities may be required for certain terminal colors.

② May only be used as a marking surface. Cannot be installed over a center jumper.

③ Specially designed to fit the screws on V7-W3, W4 and W6 terminals.

④ Custom marking tags available. See page N38 for order form.

⑤ Catalog number is not complete. See pages N36...N37.

Standard Feed-Through Blocks ①

Ordering and Technical Information ①	10mm ²		16mm ²			
	Single circuit terminal block		Single circuit terminal block			
	Catalog Number	Pkg. Qty	Catalog Number	Pkg. Qty		
Terminal - Gray	V7-W10	50	V7-W16S	50		
Red	V7-W10-RE		V7-W16S-RE			
Blue	V7-W10-B		V7-W16S-B			
Black	V7-W10-BL		V7-W16S-BL			
Green	V7-W10-G	50	V7-W16S-G	50		
Yellow	V7-W10-Y		V7-W16S-Y			
Orange	V7-W10-OR		V7-W16S-OR			
White	V7-W10-W		V7-W16S-W			
Brown	V7-W10-BR		V7-W16S-BR			
Accessories (also see pages N24...N29)						
End Barrier	V7-EB10	50	V7-EB10	50		
End Anchors						
DIN Rail — Normal Duty	V7-EA35	50	V7-EA35	50		
DIN Rail — Heavy Duty	V7-EAH35	10	V7-EAH35	10		
DIN Rail — Snap-in	V7-ER35	50	V7-ER35	50		
Jumpers						
Side Jumper — 10-pole Insulated	V7-SJ8-10	10				
Center Jumper — 40-pole	V7-CJ8-40	5				
Center Jumper — 10-pole	V7-CJ8-10	10	V7-CJS11-10	10		
Center Jumper — 3-pole	V7-CJ8-3	10	V7-CJS11-3	10		
Center Jumper — 2-pole	V7-CJ8-2	10	V7-CJS11-2	10		
Center Jumper Link	V7-CJL8	10				
Center Jumper Cover — White ②	V7-CJCW6	20				
Other Accessories						
Partition Plate	V7-PP10	50	V7-PP10	50		
Test Plug	V7-TP28	10				
Test Plug Adapter	V7-TA40	10				
Electrical Warning Plate (1-pole)	V7-EWP8-4	10				
Group Marking Carrier	V7-GM35	10	V7-GM35	1		
Marking Systems ③						
Blank Tags (cards of 100)	V7-SM8X12	5	V7-SM6X12	5		
Pre-printed Tags (sticks of 10)	V7-MP ④	10	V7-MP ④	10		
Terminal Block Specifications						
Approvals			IEC			IEC
Voltage Rating	600V AC/DC	600V AC/DC	800V AC/DC	600V AC/DC	600V AC/DC	800V AC/DC
Maximum Current	50 A	50 A	57 A	85 A	85 A	76 A
Wire Range (Rated Cross Section)	#22...8 AWG	#22...8 AWG	0.5...10mm ²	#14...4 AWG	#14...4 AWG	2.5...16mm ²
Wire Strip Length	0.51" (13 mm)			0.51" (13 mm)		
Recommended Tightening Torque	12.2...13.4 lb-in. (1.4 Nm)			18...20 lb-in. (2.1 Nm)		
Density	38 pcs./ft (125/m)			27 pcs./ft (90/m)		
Insulation Temperature Range	-40°...+195°F (-40°...+90°C)			-40°...+195°F (-40°...+90°C)		
Mounting Rail	Fits all types shown on page N30			Fits all types shown on page N30		





① Special order with minimum quantities may be required for certain terminal colors.

② May only be used as a marking surface. Cannot be installed over a center jumper.

③ Custom marking tags available. See page N38 for order form.

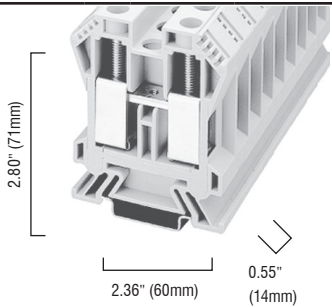
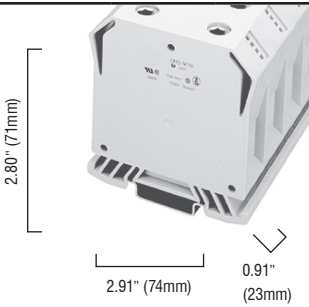
④ Catalog number is not complete. See pages N36...N37.

Standard Feed-Through Blocks ①

Ordering and Technical Information ①	35mm ²			70mm ²		
						
	2.80" (71mm)			2.80" (71mm)		
	2.36" (60mm) 0.55" (14mm)			2.91" (74mm) 0.91" (23mm)		
	Single circuit terminal block			Single circuit terminal block		
	Catalog Number	Pkg. Qty	Catalog Number	Pkg. Qty	Catalog Number	Pkg. Qty
Terminal - Gray	V7-W35	10	V7-W70	5		
Blue	V7-W35-B	10	V7-W70-B	5		
Accessories (also see pages N24...N29)						
End Barrier	V7-EB35	25	Not Required			
End Anchors						
DIN Rail — Normal Duty	V7-EA35	50				
DIN Rail — Heavy Duty	V7-EAH35	10	V7-EAH35			10
DIN Rail — Snap-in	V7-ER35	50				
Jumpers						
Center Jumper — 3-pole	V7-CJ14-3	10				
Center Jumper — 2-pole	V7-CJ14-2	10				
Other Accessories						
Partition Plate	V7-PP35	25				
Group Marking Carrier	V7-GM35	10	V7-GM35			10
Marking Systems ②						
Blank Tags (cards of 100)	V7-SM6X12	5	V7-SM6X12			5
Pre-printed Tags (sticks of 10)	V7-MP ③	10	V7-MP ③			10
Terminal Block Specifications						
Approvals			IEC			IEC
Voltage Rating	600V AC/DC	600V AC/DC	750V AC/DC	600V AC/DC	600V AC/DC	750V AC/DC
Maximum Current	140 A	125 A	138 A	310 A	200 A	175 A
Wire Range (Rated Cross Section)	#14... #1/0 AWG	#14... #1/0 AWG	2.5...35 mm ²	#4... #3/0 AWG	#4... #3/0 AWG	4...70 mm ²
Wire Strip Length	0.67" (17 mm)			1.02" (26 mm)		
Recommended Tightening Torque	22.1lb-in. (2.5 Nm)			132.8 lb-in. (15 Nm)		
Density	21 pcs./ft (71/m)			13 pcs./ft (43/m)		
Insulation Temperature Range	-40°...+195°F (-40°...+90°C)			-40°...+195°F (-40°...+90°C)		
Mounting Rail	Fits all types shown on page N30			Fits all types shown on page N30		

① Special order with minimum quantities may be required for certain terminal colors.

② Custom marking tags available. See page N38 for order form.

③ Catalog number is not complete. See pages N36...N37.

Specialty Feed-Through Blocks

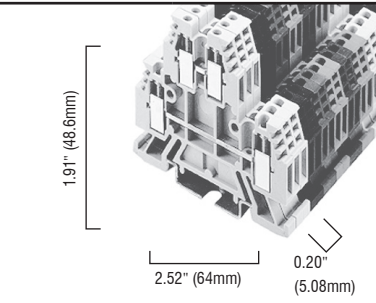
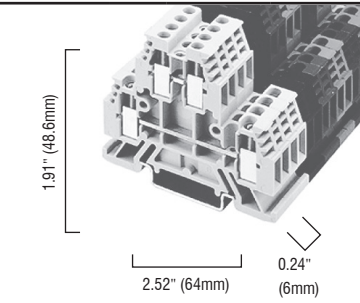
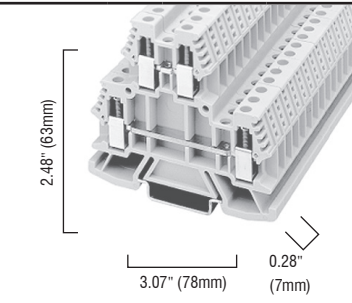
Ordering and Technical Information ①	2.5mm ²		4mm ²		6mm ²				
									
	Two circuit terminal block		Two circuit terminal block		Two circuit terminal block				
	Catalog Number	Pkg. Qty	Catalog Number	Pkg. Qty	Catalog Number	Pkg. Qty			
Terminal - Gray Blue	V7-WD3	50	V7-WD4 V7-WD4-B ①	50 50	V7-WD6	20			
Accessories (also see pages N24...N29)									
End Barrier	V7-EBD3	50	V7-EBD3	50	V7-EBD6	50			
End Anchors									
DIN Rail — Normal Duty	V7-EA35	50	V7-EA35	50	V7-EA35	50			
DIN Rail — Heavy Duty	V7-EAH35	10	V7-EAH35	10	V7-EAH35	10			
DIN Rail — Snap-in	V7-ER35	50	V7-ER35	50	V7-ER35	50			
Jumpers									
Side Jumper – 10-pole	V7-SJ5-10	10	V7-SJ6-10	10					
Center Jumper – 50-pole	V7-CJD5-50	5	V7-CJD6-50	5					
Center Jumper – 40-pole					V7-CJ7-40	5			
Center Jumper – 10-pole	V7-CJD5-10	10	V7-CJD6-10	10	V7-CJ7-10	10			
Center Jumper – 3-pole	V7-CJD5-3	10	V7-CJD6-3	10	V7-CJ7-3	10			
Center Jumper – 2-pole	V7-CJD5-2	10	V7-CJD6-2	10	V7-CJ7-2	10			
Center Jumper Link	V7-CJL5	10	V7-CJDL6	10	V7-CJL7	10			
Other Accessories									
Partition Plate	V7-PPD3	50	V7-PPD3	50	V7-PPD6	50			
Separation Plate	V7-SPD3	50	V7-SPD3	50					
Test Plug			V7-TP28	10	V7-TP28	10			
Test Plug Adapter	V7-TA285	10	V7-TA40	10	V7-TA40	10			
Electrical Warning Plate (1-pole)	V7-EWP5-4	10	V7-EWP6-4	10	V7-EWP7-4	10			
Group Marking Carrier	V7-GM35	10	V7-GM35	10	V7-GM35	5			
Marking Systems ②									
Blank Tags (cards of 100)	V7-SM5X9	5	V7-SM6X9	5	V7-SM6X12	5			
Pre-printed Tags (sticks of 10)	V7-MP5 ③	10	V7-MP ③	10	V7-MP ③	10			
Terminal Block Specifications									
Approvals	UL	UL	IEC	UL	UL	IEC	UL	UL	IEC
Voltage Rating	300V AC/DC	300V AC/DC	500V AC/DC	300V AC/DC	300V AC/DC	500V AC/DC	300V AC/DC	300V AC/DC	550V AC/DC
Maximum Current	15 A	15 A	24 A	20 A	20 A	32 A	55 A	50 A	41 A
Wire Range (Rated Cross Section)	#22... #14 AWG	#30... #14 AWG	0.5...2.5 2.5mm ²	#22... #12 AWG	#22... #10 AWG	0.5...4 4mm ²	#18... #8 AWG	#18... #8 AWG	0.5...6 mm ²
Wire Strip Length	0.39" (10 mm)			0.39" (9 mm)			0.35" (9 mm)		
Recommended Tightening Torque	5.0...5.6 lb-in. (0.6 Nm)			5.0...5.6 lb-in. (0.6 Nm)			6.2 lb-in. (0.7 Nm)		
Density	60 pcs./ft (200/m)			50 pcs./ft (166/m)			43 pcs./ft (142/m)		
Insulation Temperature Range	-40°...+195°F (-40°...+90°C)			-40°...+195°F (-40°...+90°C)			-40°...+195°F (-40°...+90°C)		
Mounting Rail	Fits all types shown on page N30			Fits all types shown on page N30			Fits all types shown on page N30		

① Special order with minimum quantities may be required for certain terminal colors.

② Custom marking tags available. See page N38 for order form.

③ Catalog number is not complete. See pages N36...N37.

Specialty Feed-Through Blocks ❶

Ordering and Technical Information ❶	2.5mm ²		2.5mm ²			
	Single circuit three conductor terminal block		Single circuit terminal block with terminals on common side.			
	Catalog Number	Pkg. Qty	Catalog Number	Pkg. Qty		
Terminal - Gray	V7-W3TW	50	V7-WR3	50		
Blue	V7-W3TW-B	50				
Accessories (also see pages N24...N29)						
End Barrier	V7-EB3TW	50	V7-EBR3	50		
End Anchors						
DIN Rail — Normal Duty	V7-EA35	50	V7-EA35	50		
DIN Rail — Heavy Duty	V7-EAH35	10	V7-EAH35	10		
DIN Rail — Snap-in	V7-ER35	50	V7-ER35	50		
Jumpers						
Side Jumper – 10-pole Insulated	V7-SJ5-10 ❸	10	V7-SJ5-10	10		
Center Jumper – 50-pole	V7-CJ5-50	5	V7-CJD5-50	5		
Center Jumper – 10-pole	V7-CJ5-10	10	V7-CJD5-10	10		
Center Jumper – 3-pole	V7-CJ5-3	10	V7-CJD5-3	10		
Center Jumper – 2-pole	V7-CJ5-2	10	V7-CJD5-2	10		
Center Jumper Link	V7-CJL5	10	V7-CJL5	10		
Center Jumper Cover – White ❹	V7-CJCW5	20	V7-CJCW5	20		
Other Accessories						
Partition Plate	V7-PP10	50	V7-EBR3	50		
Test Plug Adapter	V7-TA285	10	V7-TA285	10		
Electrical Warning Plate (1-pole)	V7-EWP5-4	10	V7-EWP5-4	10		
Group Marking Carrier	V7-GM35	10	V7-GM35	10		
Marking Systems ❺						
Blank Tags (cards of 100)	V7-SM5X9	5	V7-SM5X9	5		
Pre-printed Tags (sticks of 10)	V7-MP5 ❻	10	V7-MP5 ❻	10		
Terminal Block Specifications						
Approvals			IEC			IEC
Voltage Rating	600V AC/DC	600V AC/DC	800V AC/DC	300V AC/DC	300V AC/DC	500V AC/DC
Maximum Current	15 A	15 A	24 A	15 A	15 A	24 A
Wire Range (Rated Cross Section)	#22... #14 AWG	#30... #14 AWG	0.5...2.5 mm ²	#22... #14 AWG	#22... #14 AWG	0.5...2.5 mm ²
Wire Strip Length	0.35" (9 mm)			0.39" (10 mm)		
Recommended Tightening Torque	4.2...4.6 lb-in. (0.5 Nm)			5.0...5.6 lb-in. (0.6 Nm)		
Density	61 pcs./ft (200/m)			61 pcs./ft (200/m)		
Insulation Temperature Range	-40°...+195°F (-40°...+90°C)			-40°...+195°F (-40°...+90°C)		
Mounting Rail	Fits all types shown on page N30			Fits all types shown on page N30		

❶ Special order with minimum quantities may be required for certain terminal colors.
 ❷ Use side jumpers on the single conductor side only.

❸ May only be used as a marking surface. Cannot be installed over a center jumper.
 ❹ Custom marking tags available. See page N38 for order form.
 ❺ Catalog number is not complete. See pages N36...N37.

Grounding Blocks







Ordering and Technical Information ①	4mm ²		6mm ²		10mm ²				
	Single circuit grounding terminal block		Single circuit grounding terminal block		Single circuit grounding terminal block				
	Catalog Number	Pkg. Qty	Catalog Number	Pkg. Qty	Catalog Number	Pkg. Qty			
Terminal - green/yellow	V7-WG4	50	V7-WG6	50	V7-WG10S	10			
Accessories (also see pages N24...N29)									
End Barrier	V7-EB3-Y	50	V7-EB10-Y	50	V7-EB10-Y	50			
End Anchors									
DIN Rail — Normal Duty	V7-EA35	50	V7-EA35	50	V7-EA35	50			
DIN Rail — Heavy Duty	V7-EAH35	10	V7-EAH35	10	V7-EAH35	10			
DIN Rail — Snap-in	V7-ER35	50	V7-ER35	50	V7-ER35	50			
Other Accessories									
Group Marking Carrier	V7-GM35	10	V7-GM35	10	V7-GM35	10			
Marking Systems ②									
Blank Tags (cards of 100)	V7-SM6X12	5	V7-SM6X12	5	V7-SM8X12	5			
Pre-printed Tags (sticks of 10)	V7-MP ③	10	V7-MP ③	10					
Terminal Block Specifications									
Approvals			IEC			IEC			IEC
Voltage Rating	~	~	~	~	~	~	~	~	~
Maximum Current	Grounding			Grounding			Grounding		
Wire Range (Rated Cross Section)	#22... #14 AWG	#22... #12 AWG	4 mm ²	#22... #10 AWG	#22... #10 AWG	6 mm ²	#22... #8 AWG	#22... #8 AWG	10 mm ²
Wire Strip Length	0.43" (11 mm)			0.47" (12 mm)			0.43" (11 mm)		
Recommended Tightening Torque	5.6...6.8 lb-in. (0.7 Nm)			5.6...6.8 lb-in. (0.7 Nm)			7.1 lb-in. (0.8 Nm)		
Density	50 pcs./ft (166/m)			43 pcs./ft (142/m)			38 pcs./ft (125/m)		
Insulation Temperature Range	-40°...+195°F (-40°...+90°C)			-40°...+195°F (-40°...+90°C)			-40°...+195°F (-40°...+90°C)		
Mounting Rail	Fits all types shown on page N30			Fits all types shown on page N30			Fits all types shown on page N30		

① Refer to pages N24...N29 for a listing of all V7-W accessories.

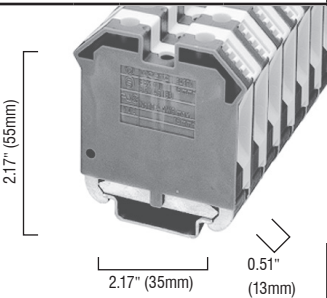
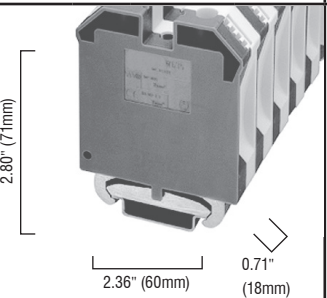
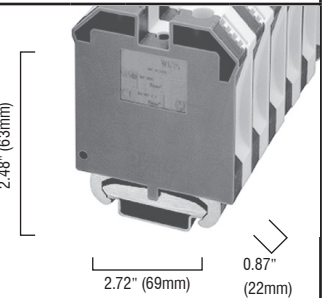
② Custom marking tags available. See page N38 for order form.

③ Catalog number is not complete. See pages N36...N37.

Grounding Blocks

Ordering and Technical Information ①	16mm ²			35mm ²			70mm ²		
									
	Single circuit grounding terminal block			Single circuit grounding terminal block			Single circuit grounding terminal block		
	Catalog Number	Pkg. Qty		Catalog Number	Pkg. Qty		Catalog Number	Pkg. Qty	
Terminal - green/yellow	V7-WG16	10		V7-WG35	10		V7-WG70	5	
Accessories (also see pages N24...N29)									
End Barrier	Not Required			Not Required			Not Required		
End Anchors	Not Required			Not Required			Not Required		
DIN Rail — Normal Duty	Not Required			Not Required			Not Required		
DIN Rail — Heavy Duty	Not Required			Not Required			Not Required		
Other Accessories									
Group Marking Carrier	V7-GM35	10		V7-GM35	10		V7-GM35	10	
Marking Systems ②									
Blank Tags (cards of 100)	V7-SM6X12	5		V7-SM6X12	5		V7-SM6X12	5	
Pre-printed Tags (sticks of 10)	V7-MP ③	10		V7-MP ③	10		V7-MP ③	10	
Terminal Block Specifications									
Approvals			IEC			IEC			IEC
Voltage Rating	~	~	~	~	~	~	~	~	~
Maximum Current	Grounding			Grounding			Grounding		
Wire Range (Rated Cross Section)	#10... #4 AWG	#10... #4 AWG	16 mm ²	#6... #1/0 AWG	#6... #1/0 AWG	35 mm ²	#4... #2/0 AWG	#4... #2/0 AWG	70 mm ²
Wire Strip Length	0.70" (18 mm)			0.83" (21 mm)			1.02" (26 mm)		
Recommended Tightening Torque	22.1 lb-in. (2.5 Nm)			44.3 lb-in. (5.0 Nm)			132 lb-in. (15 Nm)		
Density	23 pcs./ft (76/m)			16 pcs./ft (55/m)			13 pcs./ft (42/m)		
Insulation Temperature Range	-40°...+195°F (-40°...+90°C)			-40°...+195°F (-40°...+90°C)			-40°...+195°F (-40°...+90°C)		
Mounting Rail	Fits all types shown on page N30			Fits all types shown on page N30			Fits all types shown on page N30		

① Refer to pages N24...N29 for a listing of all V7-W accessories.
 ② Custom marking tags available. See page N38 for order form.
 ③ Catalog number is not complete. See pages N36...N37.

Two Level Grounding Block

Ordering and Technical Information ①		
	Two level grounding terminal block	
	Catalog Number	Pkg. Qty
Terminal - green/yellow	V7-WDG4C	50
Accessories (also see pages N24...N29)		
End Barrier	V7-EBD3-Y	50
End Anchors		
DIN Rail — Normal Duty	V7-EA35	50
DIN Rail — Heavy Duty	V7-EAH35	10
DIN Rail — Snap-in	V7-ER35	50
Jumpers		
Side Jumper - 10 pole insulated	V7-SJ6-10	10
Other Accessories		
Partition Plate	V7-PPD3	50
Group Marking Carrier	V7-GM35	10
Marking Systems ②		
Blank Tags (cards of 100)	V7-SM6X9	5
Pre-printed Tags (sticks of 10)	V7-MP ③	10
Terminal Block Specifications		
Approvals		IEC
Voltage Rating	300V AC/DC	500V AC/DC
Maximum Current	20A	32A
Wire Range (Rated Cross Section)	#22...12 AWG	0.05...4mm ²
Wire Strip Length	0.39" (10mm)	
Recommended Tightening Torque	5.0...5.6 lb-in. (0.6 Nm)	
Density	50 pcs./ft (166/m)	
Insulation Temperature Range	-40°...+195°F (-40°...90°C)	
Mounting Rail	Fits all types shown on page N30	

① Refer to pages N24...N29 for a listing of all V7-W accessories.

② Custom marking tags available. See page N38 for order form.







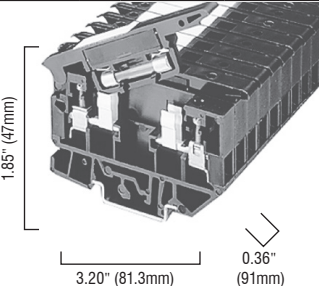
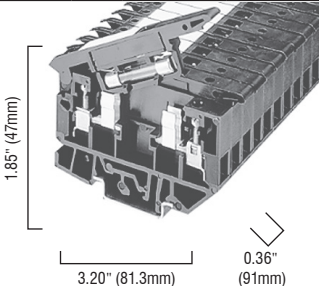
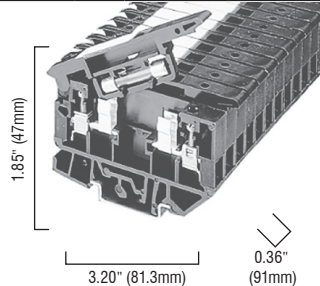

③ Catalog number is not complete. See pages N36...N37.

Fuse Blocks

Ordering and Technical Information ①	4mm ²		4mm ²		4mm ²				
	1.55" (39.4mm) 2.0" (50.7mm) 0.31" (6mm)		1.55" (39.4mm) 2.0" (50.7mm) 0.31" (6mm)		1.55" (39.4mm) 2.0" (50.7mm) 0.31" (6mm)				
	Single circuit fuse block		Single circuit fuse block with LED blown fuse indication		Single circuit fuse block with neon blown fuse indication				
	Catalog Number	Pkg. Qty	Catalog Number	Pkg. Qty	Catalog Number	Pkg. Qty			
Terminal	V7-WFB4	50	V7-WFB424	50	V7-WFB4250	50			
Accessories (also see pages N24...N29)									
End Barrier	Not Required		Not Required		Not Required				
End Anchors									
DIN Rail — Normal Duty	V7-EA35	50	V7-EA35	50	V7-EA35	50			
DIN Rail — Heavy Duty	V7-EAH35	10	V7-EAH35	10	V7-EAH35	10			
DIN Rail — Snap-in	V7-ER35	50	V7-ER35	50	V7-ER35	50			
Jumpers									
Side Jumper – 10-pole	V7-SJFB8-10	10	V7-SJFB8-10	10	V7-SJFB8-10	10			
Other Accessories									
Partition Plate	V7-PPSL3	50	V7-PPSL3	50	V7-PPSL3	50			
Group Marking Carrier	V7-GM35	10	V7-GM35	10	V7-GM35	10			
Marking Systems ②									
Blank Tags (cards of 100)	V7-SM8X12	5	V7-SM8X12	5	V7-SM8X12	5			
For Handle	V7-SM6X9	5	V7-SM6X9	5	V7-SM6X9	5			
Pre-printed Tags (sticks of 10)	V7-MP ③	10	V7-MP ③	10	V7-MP ③	10			
Terminal Block Specifications									
Approvals			IEC			IEC			IEC
Voltage Rating	300V AC/DC	300V AC/DC	500V AC/DC	300V AC/DC	300V AC/DC	500V AC/DC	300V AC/DC	300V AC/DC	500V AC/DC
Maximum Current	15 A	15 A	15 A ④	15 A	15 A	15 A ④	15 A	15 A	15 A ④
Wire Range (Rated Cross Section)	#22... #12 AWG	#22... #12 AWG	0.05...4 mm ²	#22... #12 AWG	#22... #12 AWG	0.05...4 mm ²	#22... #12 AWG	#22... #12 AWG	0.05...4 mm ²
Indicator Type	Non-Indicating			LED			Neon		
Leakage Current	~			2m A @ 24V			1m A @ 264V AC		
Working Voltage	Per Fuse Rating			10...57V AC/DC			85...264V AC		
Fuse Size (Not Supplied)	5 x 20 mm			5 x 20 mm			5 x 20 mm		
Wire Strip Length	0.31" (8mm)			0.31" (8mm)			0.31" (8mm)		
Recommended Tightening Torque	5.0...5.6 lb.-in. (0.6 Nm)			5.0...5.6 lb.-in. (0.6 Nm)			5.0...5.6 lb.-in. (0.6 Nm)		
Density	38 pcs./ft (125/m)			38 pcs./ft (125/m)			38 pcs./ft (125/m)		
Insulation Temperature Range	-40°...+195°F (-40...+90° C)			-40°...+195°F (-40...+90° C)			-40°...+195°F (-40...+90° C)		
Mounting Rail	Fits all types shown on page N30			Fits all types shown on page N30			Fits all types shown on page N30		

- ① Refer to pages N24...N29 for a listing of all V7-W accessories.
- ② Custom marking tags available. See page N38 for order form.
- ③ Catalog number is not complete. See pages N36...N37.
- ④ IEC standards for 5 x 20 mm fuses do not include ratings above 6.3 A.

Fuse Blocks

Ordering and Technical Information 	4mm ²		4mm ²		4mm ²				
									
	Single circuit fusible terminal block with neon blown fuse indicator		Single circuit fusible terminal block with LED blown fuse indicator		Single circuit fusible terminal block without a blown fuse indicator				
Catalog Number	Pkg. Qty	Catalog Number	Pkg. Qty	Catalog Number	Pkg. Qty				
Terminal	V7-H4	25	V7-H5	25	V7-H6	25			
Accessories (also see pages N24...N29)									
End Barrier	V7-N37	50	V7-N37	50	V7-N37	50			
End Anchors									
DIN Rail — Normal Duty	V7-EA35	50	V7-EA35	50	V7-EA35	50			
DIN Rail — Heavy Duty	V7-EAH35	10	V7-EAH35	10	V7-EAH35	10			
DIN Rail — Snap-in	V7-ER35	50	V7-ER35	50	V7-ER35	50			
Jumpers									
Side Jumper — 10-pole Uninsulated	V7-N49	10	V7-N49	10	V7-N49	10			
Side Jumper — Insulating Sleeve	V7-SJS	10	V7-SJS	10	V7-SJS	10			
Other Accessories									
Group Marking Carrier	V7-GM35	10	V7-GM35	10	V7-GM35	10			
Marking Systems 									
Blank Tags (cards of 100)	V7-SM8X12	5	V7-SM8X12	5	V7-SM8X12	5			
Terminal Block Specifications									
Approvals			IEC			IEC			IEC
Voltage Rating	300V AC/DC	300V AC/DC	500V AC/DC	300V AC/DC	300V AC/DC	500V AC/DC	300V AC/DC	300V AC/DC	500V AC/DC
Maximum Current	12 A	12 A	12 A	12 A	12 A	12 A	12 A	12 A	12 A
Wire Range (Rated Cross Section)	#30... #12 AWG	#30... #12 AWG	0.05...2.5 mm ²	#30... #12 AWG	#30... #12 AWG	0.05...4 mm ²	#30... #12 AWG	#30... #12 AWG	0.05...4 mm ²
Indicator Type	Neon			LED			Non-Indicating		
Leakage Current	2m A @ 300V			2m A @ 24V					
Working Voltage	100...300V AC/DC			10...57V AC/DC			Per Fuse Rating		
Fuse Size (Not Supplied)	1/4" x 1-1/4"			1/4" x 1-1/4"			1/4" x 1-1/4"		
Wire Strip Length	0.38" (9.7 mm)			0.38" (9.7 mm)			0.38" (9.7 mm)		
Recommended Tightening Torque	3...7 lb.-in. (0.3...0.8 Nm)			3...7 lb.-in. (0.3...0.8 Nm)			3...7 lb.-in. (0.3...0.8 Nm)		
Density	33 pcs./ft (109/m)			33 pcs./ft (109/m)			33 pcs./ft (109/m)		
Insulation Temperature Range	-40°...+221°F (-40...+105° C)			-40°...+221°F (-40...+105° C)			-40°...+221°F (-40...+105° C)		
Mounting Rail	Fits all types shown on page N30			Fits all types shown on page N30			Fits all types shown on page N30		

 Refer to pages N24...N29 for a listing of all V7-W accessories.







 Custom marking tags available. See page N38 for order form.

Fuse Blocks

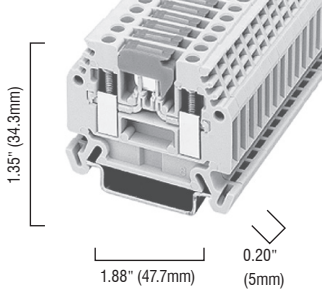
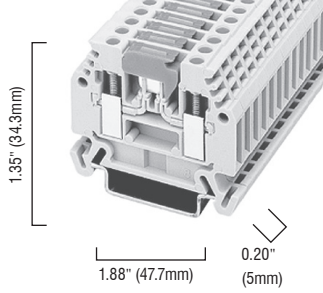
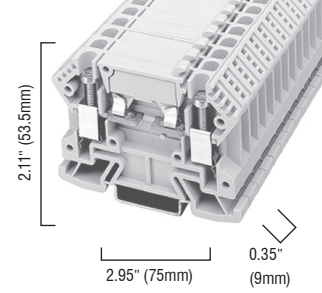
Ordering and Technical Information ①	4mm ²		4mm ²	
	Single circuit fuse block		Single circuit fuse block	
	Catalog Number	Pkg. Qty	Catalog Number	Pkg. Qty
Terminal	V7-WFB10V	25	V7-WFB10VA	25
Accessories (also see pages N24...N29)				
End Barrier	V7-EBFB10V	50	V7-EBFB10V	50
End Anchors				
DIN Rail — Normal Duty	V7-EA35	50	V7-EA35	50
DIN Rail — Heavy Duty	V7-EAH35	10	V7-EAH35	10
DIN Rail — Snap-in	V7-ER35	50	V7-ER35	50
Other Accessories				
Replacement Fuse Knob	V7-FCA	5	V7-FCA	5
Group Marking Carrier	V7-GM35	10	V7-GM35	10
Marking Systems ②				
Blank Tags (cards of 100)	V7-SM6X12	5	V7-SM6X12	5
Pre-printed Tags (sticks of 10)	V7-MP ③	10	V7-MP ③	10
Terminal Block Specifications				
Approvals		IEC		IEC
Voltage Rating	300V AC/DC	250V AC/DC	300V AC/DC	250V AC/DC
Maximum Current	10 A	10 A	10 A	10 A
Wire Range (Rated Cross Section)	#20...8 AWG	10mm ²	#20...8 AWG	10mm ²
Indicator Type	Non-Indicating		Non-Indicating	
Leakage Current	~		~	
Working Voltage	Per Fuse Rating		Per Fuse Rating	
Fuse Size (Not Supplied)	5 x 20 mm		1/4 in. x 1-1/4 in. (6.3 x 32mm)	
Wire Strip Length	0.51" (13 mm)		0.51" (13 mm)	
Recommended Tightening Torque	13 lb-in. (1.5 Nm)		13 lb-in. (1.5 Nm)	
Density	23 pcs./ft (75/m)		23 pcs./ft (75/m)	
Insulation Temperature Range	-40°...+195°F (-40°...+90°C)		-40°...+195°F (-40°...+90°C)	
Mounting Rail	Fits all types shown on page N30		Fits all types shown on page N30	



- ① Refer to pages N24...N29 for a listing of all V7-W accessories.
- ② Custom marking tags available. See page N38 for order form.
- ③ Catalog number is not complete. See pages N36...N37.

Isolation Blocks

Ordering and Technical Information ①	2.5mm ²			2.5mm ²			6mm ²		
									
	Knife style isolating terminal block			Knife style isolating terminal block with test plug screws			Knife style isolating terminal block		
	Catalog Number	Pkg. Qty	Catalog Number	Pkg. Qty	Catalog Number	Pkg. Qty	Catalog Number	Pkg. Qty	
Terminal - Gray	V7-WKD3	50	V7-WKD3TP	50	V7-WKD6	20			
Accessories (also see pages N24...N29)									
End Barrier	V7-EBKD3	50	V7-EBKD3	50	Not Required				
End Anchors									
DIN Rail — Normal Duty	V7-EA35	50	V7-EA35	50	V7-EA35	50			
DIN Rail — Heavy Duty	V7-EAH35	10	V7-EAH35	10	V7-EAH35	10			
DIN Rail — Snap-in	V7-ER35	50	V7-ER35	50	V7-ER35	50			
Jumpers									
Side jumper - 10-pole insulated	V7-SJ5-10	10	V7-SJ5-10	10					
Other Accessories									
Partition Plate	V7-PPSL3	50	V7-PPSL3	50					
Test Plug			V7-TP15	10					
Group Marking Carrier	V7-GM35	10	V7-GM35	10	V7-GM35	10			
Marking Systems ②									
Blank Tags (cards of 100)	V7-SM5X9	5	V7-SM5X9	5	V7-SM6X12	5			
Pre-printed Tags (sticks of 10)	V7-MP5 ③	10	V7-MP5 ③	10	V7-MP5 ③	10			
Terminal Block Specifications									
Approvals			IEC			IEC			IEC
Voltage Rating	600V AC/DC	600V AC/DC	800V AC/DC	300V AC/DC	300V AC/DC	800V AC/DC	600V AC/DC	600V AC/DC	800V AC/DC
Maximum Current	15A	15A	15A	15A	15A	15A	30A	30A	32A
Wire Range (Rated Cross Section)	#22... #14 AWG	#22... #14 AWG	0.5...2.5 mm ²	#22... #14 AWG	#22... #14 AWG	0.5...2.5 mm ²	#18... #10 AWG	#18... #10 AWG	0.5...6 mm ²
Wire Strip Length	0.35" (9 mm)			0.35" (9 mm)			0.55" (14 mm)		
Recommended Tightening Torque	5.0...5.6 lb-in. (0.6 Nm)			5.0...5.6 lb-in. (0.6 Nm)			7.1 lb-in. (0.8 Nm)		
Density	61 pcs./ft (200/m)			61 pcs./ft (200/m)			33 pcs./ft (111/m)		
Insulation Temperature Range	-40°...+195°F (-40°...+90°C)			-40°...+195°F (-40°...+90°C)			-40°...+195°F (-40°...+90°C)		
Mounting Rail	Fits all types shown on page N30			Fits all types shown on page N30			Fits all types shown on page N30		

① Refer to pages N24-29 for a listing of all V7-W accessories.
 ② Custom marking tags available. See page N38 for order form.
 ③ Catalog number is not complete. See pages N36...N37.

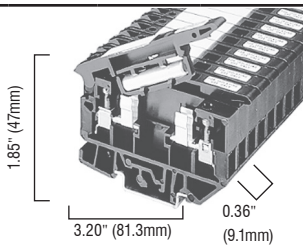
Isolation Blocks

Ordering and Technical Information ①	4mm²		
			
	Handle style isolating terminal block		
	Catalog Number	Pkg. Qty	
Terminal - Black	V7-H7	25	
Accessories (also see pages N24...N29)			
End Barrier	V7-N37	50	
End Anchors			
DIN Rail — Normal Duty	V7-EA35	50	
DIN Rail — Heavy Duty	V7-EAH35	10	
DIN Rail — Snap-in	V7-ER35	50	
Jumpers			
Side Jumper - 10 pole Uninsulated	V7-N49	10	
Side Jumper - Insulating Sleeve	V7-SJS	10	
Other Accessories			
Group Marking Carrier	V7-GM35	10	
Marking Systems ②			
Blank Tags (cards of 100)	V7-SM8X12	5	
Terminal Block Specifications			
Approvals			IEC
Voltage Rating	300V AC/ DC	300V AC/DC	500V AC/ DC
Maximum Current	15A	15A	15A
Wire Range (Rated Cross Section)	#30... 12 AWG	#30... 12 AWG	0.5...4 mm ²
Wire Strip Length	0.38" (9.7mm)		
Recommended Tightening Torque	3...7 lb-in. (0.3...0.8 Nm)		
Density	33 pcs./ft (109/m)		
Insulation Temperature Range	-40°...+221°F (-40°...105°C)		
Mounting Rail	Fits all types shown on page N30		

① Refer to pages N24...N29 for a listing of all V7-W accessories.
 ② Custom marking tags available. See page N38 for order form.

Sensor Blocks

Ordering and Technical Information	2.5mm ²			2.5mm ²			2.5mm ²		
	Three circuit terminal block			Three circuit terminal block with LED indicator for PNP devices			Three circuit terminal block with LED indicator for NPN devices		
	Catalog Number	Price Ea. (Std Pkg)	Pkg. Qty	Catalog Number	Price Ea. (Std Pkg)	Pkg. Qty	Catalog Number	Price Ea. (Std Pkg)	Pkg. Qty
Terminal - Gray	V7-WTF3	5.29	50	V7-WTF3LP	10.95	50	V7-WTF3LN	10.95	50
Accessories (also see pages N24...N29)									
End Barrier	V7-EBTF3		50	V7-EBTF3		50	V7-EBTF3		50
End Anchors									
DIN Rail — Normal Duty	V7-EA35		50	V7-EA35		50	V7-EA35		50
DIN Rail — Heavy Duty	V7-EAH35		10	V7-EAH35		10	V7-EAH35		10
DIN Rail — Snap-in	V7-ER35		50	V7-ER35		50	V7-ER35		50
Jumpers									
Side Jumper — 20-pole Insulated - Red	V7-SJT5-20-R	See Accessory Pages for Pricing	10	V7-SJT5-20-R	See Accessory Pages for Pricing	10	V7-SJT5-20-R	See Accessory Pages for Pricing	10
Side Jumper — 20-pole Insulated - Blue	V7-SJT5-20-B		10	V7-SJT5-20-B		10	V7-SJT5-20-B		10
Center Jumper — 50-pole	V7-CJT5-50		5	V7-CJT5-50		5	V7-CJT5-50		5
Center Jumper — 10-pole	V7-CJT5-10		10	V7-CJT5-10		10	V7-CJT5-10		10
Center Jumper Link	V7-CJL5		10	V7-CJL5		10	V7-CJL5		10
Other Accessories									
Partition Plate	V7-PPTS3		50	V7-PPTS3		50	V7-PPTS3		50
Test Plug Adaptor	V7-TA285		10	V7-TA285		10	V7-TA285		10
Electrical Warning Plate (1-pole)	V7-EWP5-4		10	V7-EWP5-4		10	V7-EWP5-4		10
Group Marking Carrier	V7-GM35		10	V7-GM35		10	V7-GM35		10
Marking Systems									
Blank Tags (cards of 100)	V7-SM5X9		5	V7-SM5X9		5	V7-SM5X9		5
Pre-printed Tags (sticks of 10)	V7-MP5		10	V7-MP5		10	V7-MP5		10
Terminal Block Specifications									
Approvals	UL	UL	IEC	UL	UL	IEC	UL	UL	IEC
Voltage Rating	300V AC/DC	300V AC/DC	250V AC/DC	300V AC/DC	300V AC/DC	250V AC/DC	300V AC/DC	300V AC/DC	250V AC/DC
Maximum Current	10 A	10 A	24 A	10 A	10 A	24 A	10 A	10 A	24 A
Wire Range (Rated Cross Section)	#26... #14 AWG	#26... #14 AWG	0.5...2.5 mm ²	#26... #14 AWG	#26... #14 AWG	0.5...2.5 mm ²	#26... #14 AWG	#26... #14 AWG	0.5...2.5 mm ²
Indicator Type - Red LED				10...50 VDC			10...50 VDC		
Leakage Current				2.69mA @ 50V			2.69mA @ 50V		
Wire Strip Length	0.31" (8 mm)			0.31" (8 mm)			0.31" (8 mm)		
Recommended Tightening Torque	4.2...4.6 lb-in. (0.5 Nm)			4.2...4.6 lb-in. (0.5 Nm)			4.2...4.6 lb-in. (0.5 Nm)		
Density	60 pcs./ft (197/m)			60 pcs./ft (197/m)			60 pcs./ft (197/m)		
Insulation Temperature Range	-40°...+195°F (-40°...+90°C)			-40°...+195°F (-40°...+90°C)			-40°...+195°F (-40°...+90°C)		
Mounting Rail	Fits all types shown on page N30			Fits all types shown on page N30			Fits all types shown on page N30		
Wiring Diagram	See page N42								

- ① May require special order with minimum quantities.
- ② Custom marking tags available. See page N38 for order form.
- ③ Catalog number is not complete. See pages N36...N37.

Sensor Blocks

Ordering and Technical Information 1	2.5mm²	2.5mm²	2.5mm²			
	Three level sensor block	Three level sensor block LED indicator for PNP devices	Three level sensor block LED indicator for NPN devices			
	Catalog Number	Pkg. Qty	Catalog Number	Pkg. Qty	Catalog Number	Pkg. Qty
Terminal - Gray	V7-WTS3	50	V7-WTS3LP 1	50	V7-WTS3LN 1	50

Accessories (also see pages N24...N29)

End Barrier	V7-EBTS3	50	V7-EBTS3	50	V7-EBTS3	50
End Anchors						
DIN Rail — Normal Duty	V7-EA35	50	V7-EA35	50	V7-EA35	50
DIN Rail — Heavy Duty	V7-EAH35	10	V7-EAH35	10	V7-EAH35	10
DIN Rail — Snap-in	V7-ER35	50	V7-ER35	50	V7-ER35	50
Jumpers						
Side Jumper — 20-pole Insulated - Red	V7-SJT5-20-R	10	V7-SJT5-20-R	10	V7-SJT5-20-R	10
Side Jumper — 20-pole Insulated - Blue	V7-SJT5-20-B	10	V7-SJT5-20-B	10	V7-SJT5-20-B	10
Center Jumper — 50-pole	V7-CJT5-50	5	V7-CJT5-50	5	V7-CJT5-50	5
Center Jumper — 10-pole	V7-CJT5-10	10	V7-CJT5-10	10	V7-CJT5-10	10
Center Jumper Link	V7-CJL5	10	V7-CJL5	10	V7-CJL5	10
Other Accessories						
Partition Plate	V7-PPTS3	50	V7-PPTS3	50	V7-PPTS3	50
Test Plug Adapter	V7-TA285	10	V7-TA285	10	V7-TA285	10
Electrical Warning Plate (1-pole)	V7-EWP5-4	10	V7-EWP5-4	10	V7-EWP5-4	10
Group Marking Carrier	V7-GM35	10	V7-GM35	10	V7-GM35	10
Marking Systems 2						
Blank Tags (cards of 100) 2	V7-SM5X9	5	V7-SM5X9	5	V7-SM5X9	5
Pre-printed Tags (sticks of 10)	V7-MP5 3	10	V7-MP5 3	10	V7-MP5 3	10

Terminal Block Specifications

Approvals	UL			IEC			UL			IEC		
	UL	UL	IEC	UL	UL	IEC	UL	UL	IEC	UL	UL	IEC
Voltage Rating	300V	300V	250V AC/DC	300V AC/DC	300V AC/DC	250V AC/DC	300V AC/DC	300V AC/DC	300V AC/DC	250V AC/DC	300V AC/DC	250V AC/DC
Maximum Current	10 A	10 A	24 A	10 A	10 A	24 A	10 A	10 A	10 A	24 A	10 A	24 A
Wire Range (Rated Cross Section)	#26... #14 AWG	#26... #14 AWG	0.5...2.5 mm ²	#26... #14 AWG	#26... #14 AWG	0.5...2.5 mm ²	#26... #14 AWG	#26... #14 AWG	#26... #14 AWG	0.5...2.5 mm ²	#26... #14 AWG	0.5...2.5 mm ²
Leakage Current				2.69mA @ 50V						2.69mA @ 50V		
Wire Strip Length	0.31" (8 mm)			0.31" (8 mm)			0.31" (8 mm)			0.31" (8 mm)		
Recommended Tightening Torque	4.2...4.6 lb-in. (0.5 Nm)			4.2...4.6 lb-in. (0.5 Nm)			4.2...4.6 lb-in. (0.5 Nm)			4.2...4.6 lb-in. (0.5 Nm)		
Density	60 pcs./ft (197/m)			60 pcs./ft (197/m)			60 pcs./ft (197/m)			60 pcs./ft (197/m)		
Insulation Temperature Range	-40°...+195°F (-40°...+90°C)			-40°...+195°F (-40°...+90°C)			-40°...+195°F (-40°...+90°C)			-40°...+195°F (-40°...+90°C)		
Mounting Rail	Fits all types shown on page N30			Fits all types shown on page N30			Fits all types shown on page N30			Fits all types shown on page N30		
Wiring Diagram	See page N42			See page N42			See page N42			See page N42		

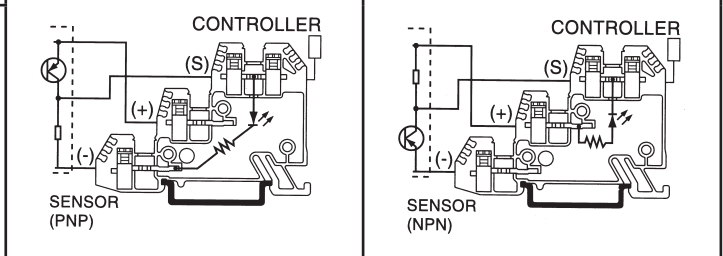

- 1 May require special order with minimum quantities.
- 2 Custom marking tags available. See page N38 for order form.
- 3 Catalog number is not complete. See pages N36...N37.

Plug-in Style Blocks

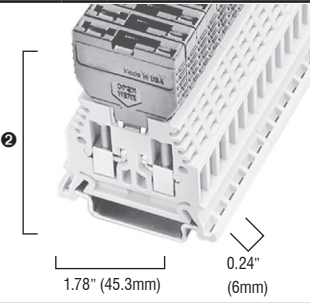
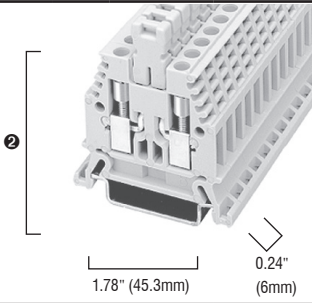
Ordering and Technical Information ❶	2.5mm ²		2.5mm ²			
						
	1.78" (45.3mm) 0.24" (6mm)		1.78" (45.3mm) 0.24" (6mm)			
	Pluggable terminal block		Pluggable terminal block with test plug screws			
	Catalog Number	Pkg. Qty	Catalog Number	Pkg. Qty		
Terminal - Gray	V7-W4P	50	V7-W4PTP	50		
Accessories (also see pages N24...N29)						
Inserts						
Disconnect Plug	V7-DP4	50	V7-DP4 (shown)	50		
Component Plug	V7-CP4 ❸❸	50	V7-CP4 ❸	50		
Fuse Plug	V7-FP4 ❸ (shown)	50	V7-FP4 ❸❸	50		
Fuse Plug w/LED Blown Fuse Indication	V7-FP424 ❸❸	50	V7-FP424 ❸❸	50		
Fuse Plug w/LED Blown Fuse Indication	V7-FP4250 ❸❸	50	V7-FP4250 ❸❸	50		
End Barrier	V7-EB3	50	V7-EB3	50		
End Anchors						
DIN Rail — Normal Duty	V7-EA35	50	V7-EA35	50		
DIN Rail — Heavy Duty	V7-EAH35	10	V7-EAH35	10		
DIN Rail — Snap-in	V7-ER35	50	V7-ER35	50		
Jumpers						
Side Jumper — 10-pole Insulated	V7-SJ6-10	10	V7-SJ6-10	10		
Other Accessories						
Partition Plate	V7-PP3	50	V7-PP3	50		
Test Plug			V7-TP23	50		
Group Marking Carrier	V7-GM35	10	V7-GM35	10		
Marking Systems ❹						
Blank Tags (cards of 100)	V7-SM6X12	5	V7-SM6X12	5		
Pre-printed Tags (sticks of 10)	V7-MP ❷	10	V7-MP ❷	10		
Terminal Block Specifications						
Approvals	UL	UL	IEC	UL	UL	IEC
Voltage Rating	600V AC/DC	600V AC/DC	800V AC/DC	600V AC/DC	600V AC/DC	800V AC/DC
Maximum Current	20 A	20 A	32 A	20 A	20 A	32 A
Wire Range (Rated Cross Section)	#22... #12 AWG	#22... #12 AWG	0.5...2.5 mm ²	#22... #12 AWG	#22... #12 AWG	0.5...2.5 mm ²
Wire Strip Length	0.35" (9mm)			0.35" (9mm)		
Recommended Tightening Torque	5.0...5.6 lb-in. (0.6 Nm)			5.0...5.6 lb-in. (0.6 Nm)		
Density	50 pcs./ft (166/m)			50 pcs./ft (166/m)		
Insulation Temperature Range	-40°...+195°F (-40°...+90°C)			-40°...+195°F (-40°...+90°C)		
Mounting Rail	Fits all types shown on page N30			Fits all types shown on page N30		

❶ Refer to pages N24...N29 for a listing of all V7-W accessories.
 ❷ Overall height varies with plug-in component. For V7-DP4, use 2.5" (63.5 mm); for V7-CP4, use 2.9" (74 mm); and for V7-FP4..., use 3.1" (78 mm).
 ❸ Maximum current and voltage rating of component plug is 0.5W @ 250V maximum current rating for the base terminal block is listed under Specifications.

❹ Maximum current and voltage ratings for the fuse plug are 10A and 250V. Maximum ratings for the base blocks are listed under Specifications.
 ❺ See page N42 for Fuse Plug Specifications.
 ❻ Custom marking tags available. See page N38 for order form.
 ❼ Catalog number is not complete. See pages N36...N37.











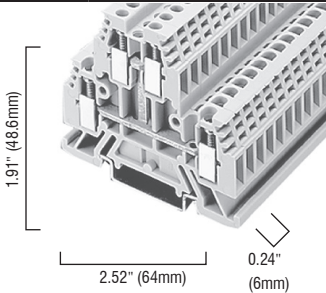
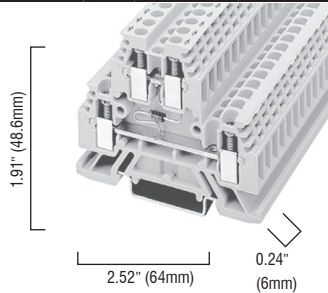
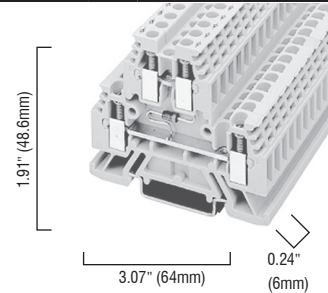



Multi-level Plug-in Style Blocks



Ordering and Technical Information ①	2.5mm ²		2.5mm ²			
	Two level terminal block with top level capable of accepting plug-in components and lower level acting as an independent feed-through circuit		Three level terminal block with top level capable of accepting plug-in components second level acting as an independent feed-through circuit, and third level acting as a grounding circuit			
	Catalog Number	Pkg. Qty	Catalog Number	Pkg. Qty		
Terminal - Gray	V7-WD4P	50	V7-WDG4P	50		
Accessories (also see pages N24...N29)						
Inserts						
Disconnect Plug	V7-DP4 (shown)	50	V7-DP4 (shown)	50		
Component Plug	V7-CP4 ②	50	V7-CP4 ②	50		
Fuse Plug	V7-FP4 ③④	50	V7-FP4 ③④	50		
Fuse Plug w/LED Blown Fuse Indication	V7-FP424 ③④	50	V7-FP424 ③④	50		
Fuse Plug w/LED Blown Fuse Indication	V7-FP4250 ③④	50	V7-FP4250 ③④	50		
End Barrier	V7-EBD4P	50	V7-EBD4P	50		
End Anchors						
DIN Rail — Normal Duty	V7-EA35	50	V7-EA35	50		
DIN Rail — Heavy Duty	V7-EAH35	10	V7-EAH35	10		
DIN Rail — Snap-in	V7-ER35	50	V7-ER35	50		
Jumpers						
Side Jumper – 10-pole Insulated	V7-SJ6-10	10	V7-SJ6-10	10		
Center Jumper – 50-pole	V7-CJD6-50	5				
Center Jumper – 10-pole	V7-CJD6-10	10	V7-CJD6-10	10		
Center Jumper – 3-pole	V7-CJD6-3	10	V7-CJD6-3	10		
Center Jumper – 2-pole	V7-CJD6-2	10	V7-CJD6-2	10		
Center Jumper Link	V7-CJDL6	10	V7-CJDL6	10		
Other Accessories						
Test Plug	V7-TP28	10	V7-TP28	10		
Test Plug Adapter	V7-TA40	10	V7-TA40	10		
Group Marking Carrier	V7-GM35	10	V7-GM35	10		
Marking Systems ⑤						
Blank Tags (cards of 100)	V7-SM6X9	5	V7-SM6X9	5		
Pre-printed Tags (sticks of 10)	V7-MP ⑦	10	V7-MP ⑦	10		
Terminal Block Specifications						
Approvals			IEC			IEC
Voltage Rating	300V AC/DC	300V AC/DC	500V AC/DC	300V AC/DC	300V AC/DC	500V AC/DC
Maximum Current	15 A	15 A	20 A	15 A	15 A	20 A
Wire Range (Rated Cross Section)	#22... #12 AWG	#22... #12 AWG	0.5...2.5 mm ²	#22... #12 AWG	#22... #12 AWG	0.5...2.5 mm ²
Wire Strip Length	0.31" (8mm)			0.31" (8mm)		
Recommended Tightening Torque	5.0...5.6 lb-in. (0.6 Nm)			5.0...5.6 lb-in. (0.6 Nm)		
Density	50 pcs./ft (166/m)			50 pcs./ft (166/m)		
Insulation Temperature Range	-40°...+195°F (-40°...+90°C)			-40°...+195°F (-40°...+90°C)		
Mounting Rail	Fits all types shown on page N30			Fits all types shown on page N30		

① Refer to pages N24...N29 for a listing of all V7-W accessories.
 ② Overall height varies with plug-in component. For V7-DP4, use 2.5" (63.5 mm); for V7-CP4, use 2.9" (74 mm); and for V7-FP4..., use 3.1" (78 mm).
 ③ Maximum current and voltage rating of component plug is 1A @ 600V. Maximum current rating for the base terminal block is listed under Specifications.

④ Maximum current and voltage ratings for the fuse plug are 10A and 250V. Maximum ratings for the base blocks are listed under Specifications.
 ⑤ See page N42 for Fuse Plug Specifications.
 ⑥ Custom marking tags available. See page N38 for order form.
 ⑦ Catalog number is not complete. See pages N36...N37.

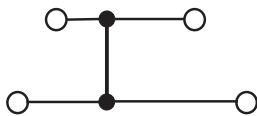
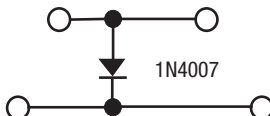
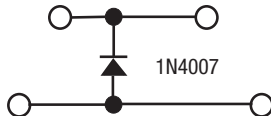
Component Blocks

Ordering and Technical Information 	4mm ²		4mm ²		4mm ²				
									
	Two level block with a commoning bar between the upper and lower levels, providing multiple outlets	Two level block with a diode in forward bias between the upper and lower levels	Two level block with a diode in reverse bias between the upper and lower levels						
Catalog Number	Pkg. Qty	Catalog Number	Pkg. Qty	Catalog Number	Pkg. Qty	Catalog Number	Pkg. Qty	Catalog Number	Pkg. Qty
Terminal - Gray	V7-WD4C	50	V7-WD4DF 	1	V7-WD4DR 	1			
Accessories (also see pages N24 - N29)									
End Barrier	V7-EBD3	50	V7-EBD3	50	V7-EBD3	50			
End Anchors									
DIN Rail — Normal Duty	V7-EA35	50	V7-EA35	50	V7-EA35	50			
DIN Rail — Heavy Duty	V7-EAH35	10	V7-EAH35	10	V7-EAH35	10			
DIN Rail — Snap-in	V7-ER35	50	V7-ER35	50	V7-ER35	50			
Jumpers									
Side Jumper — 10-pole Insulated	V7-SJ6-10	10	V7-SJ6-10	10	V7-SJ6-10	10			
Center Jumper — 50-pole	V7-CJD6-50	5	V7-CJD6-50	5	V7-CJD6-50	5			
Center Jumper — 10-pole	V7-CJD6-10	10	V7-CJD6-10	10	V7-CJD6-10	10			
Center Jumper — 3-pole	V7-CJD6-3	10	V7-CJD6-3	10	V7-CJD6-3	10			
Center Jumper — 2-pole	V7-CJD6-2	10	V7-CJD6-2	10	V7-CJD6-2	10			
Center Jumper Link	V7-CJDL6	10	V7-CJDL6	10	V7-CJDL6	10			
Other Accessories									
Partition Plate	V7-PPD3	50	V7-PPD3	50	V7-PPD3	50			
Separation Plate	V7-SPD3	10	V7-SPD3	10	V7-SPD3	10			
Test Plug	V7-TP28	10	V7-TP28	10	V7-TP28	10			
Test Plug Adapter	V7-TA40	10	V7-TA40	10	V7-TA40	10			
Group Marking Carrier	V7-GM35	10	V7-GM35	10	V7-GM35	10			
Marking Systems 									
Blank Tags (cards of 100)	V7-SM6X9	5	V7-SM6X9	5	V7-SM6X9	5			
Pre-printed Tags (sticks of 10)	V7-MP 	10	V7-MP 	10	V7-MP 	10			
Terminal Block Specifications									
Approvals			IEC			IEC			IEC
Voltage Rating	300V AC/DC	300V AC/DC	500V AC/DC	300V AC/DC	300V AC/DC	500V AC/DC	300V AC/DC	300V AC/DC	500V AC/DC
Maximum Current	20 A	20 A	32 A	1 A (Diode)	1 A (Diode)	1 A (Diode)	1 A (Diode)	1 A (Diode)	1 A (Diode)
Wire Range (Rated Cross Section)	#22... #12 AWG	#22... #12 AWG	0.05...4 mm ²	#22... #12 AWG	#22... #12 AWG	0.05...4 mm ²	#22... #12 AWG	#22... #12 AWG	0.05...4 mm ²
Working Voltage				Diode 1N4007 			Diode 1N4007 		
Wire Strip Length	0.39" (10mm)			0.39" (10mm)			0.39" (10mm)		
Recommended Tightening Torque	5.0...5.6 lb-in. (0.6 Nm)			5.0...5.6 lb-in. (0.6 Nm)			5.0...5.6 lb-in. (0.6 Nm)		
Density	50 pcs./ft (166/m)			50 pcs./ft (166/m)			50 pcs./ft (166/m)		
Insulation Temperature Range	-40°...+195°F (-40°...+90°C)			-40°...+195°F (-40°...+90°C)			-40°...+195°F (-40°...+90°C)		
Mounting Rail	Fits all types shown on page N30			Fits all types shown on page N30			Fits all types shown on page N30		
Schematics									
Diode Block									
Uses a 1N4007 diode between the upper and lower levels for insertion into a control circuit. This block is useful in low voltage DC control circuits for directioning and suppression.									

 May require special order with minimum quantities.
 Custom marking tags available. See page N38 for order form.



 Catalog number is not complete. See pages N36...N37.
 See page N41 for Component Specifications.

Thermocouple Blocks ①

Ordering and Technical Information ①	2.5mm²	
	Two-pole thermocouple block	
	Catalog Number	Pkg. Qty
Current Bar Material		
Pos. Leg / Neg. Leg	Trade Name	
NiCr / CuNi	Chromel / Constantan	V7-WTC3E
Ir / CuNi	Iron / Constantan	V7-WTC3J
Cu / CuNi	Copper / Constantan	V7-WTC3T
Accessories (also see pages N24 - N29)		
End Barrier	V7-EB3	50
End Anchors		
DIN Rail — Normal Duty	V7-EA35	50
DIN Rail — Heavy Duty	V7-EAH35	10
DIN Rail — Snap-in	V7-ER35	50
Other Accessories		
Partition Plate	V7-PP3	
Group Marking Carrier	V7-GM35	10
Marking Systems ②		
Blank Tags (cards of 100) ②	V7-SM5X9	5
Pre-printed Tags (sticks of 10)	V7-MP5 ③	10
Terminal Block Specifications		
Approvals		
Wire Range (Rated Cross Section)	0.28...#14 AWG 0.2...2.5 mm ²	
Wire Strip Length	0.35" (10mm)	
Recommended Tightening Torque	5.0...5.6 lb-in. (0.6 Nm)	
Density	30 pcs./ft (100/m)	
Insulation Temperature Range	-40°...+195°F (-40°...105°C)	
Mounting Rail	Fits all types shown on page N30	



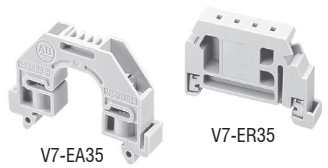
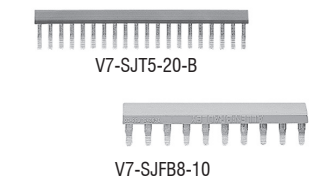

① May require special order with minimum quantities.
 ② Custom marking tags available. See page N38 for order form.
 ③ Catalog number is not complete. See pages N36...N37.

Accessories

Component	Description	Type	Catalog Number	Std. Pkg.	pg. N5	pg. N5	pg. N5	pg. N6	pg. N6
					-W3 Through	-W4 Through	-W6 Through	-W10 Through	-W16S Through
Ordering Instructions: 1. Identify accessory required. 2. Identify terminal block along top of table. 3. Use matrix to determine which Accessory Type to order.	 <p>End Barrier Provides insulation for the last terminal block in a group. Gray unless noted.</p>		V7-EB10	50					
		(shown)	V7-EB3	50	■	■			
			V7-EB3TW	50					
		(shown)	V7-EB35	25					
			V7-EBD3	50					
		yellow	V7-EBD3-Y	50					
			V7-EBD6	50					
			V7-EBD4P	50					
			V7-EBKD3	50					
			V7-EBR3	50					
			V7-EBTF3	50					
		(shown)	V7-EBTS3	50					
		yellow	V7-N37	50					
yellow	V7-EB10-Y	50							
yellow	V7-EB3-Y	50							
	V7-EBFB10V	50							
 <p>End Anchor (Screw type) Anchors a row of blocks or a single block</p>	Standard (shown)	V7-EA35	50	■	■	■	■	■	
	Heavy Duty	V7-EAH35	10	■	■	■	■	■	
	Snap In (shown)	V7-ER35	50	■	■	■	■	■	
 <p>Side Jumpers Insulated, fit in wire openings of blocks</p>		V7-SJ5-10	10	■					
		V7-SJ6-10	10		■				
		V7-SJ8-10	10				■		
	(shown)	V7-SJFB8-10	10						
	Blue	V7-SJT5-20-B	10						
	Red	V7-SJT5-20-R	10						
Non-insulated	V7-N49	10							
 <p>Insulating Side Jumper Sleeve For use with catalog # V7-N49</p> <p>Replacement Fuse Knob</p>		V7-SJS	10						
		V7-FCM	50						
 <p>Center Jumpers Uninsulated, screw into threaded hole in center of block (See page N28 for more Center Jumpers)</p>	2 pole	V7-CJ5-2	10	■					
	3 pole	V7-CJ5-3	10	■					
	10 pole	V7-CJ5-10	10	■					
	50 pole	V7-CJ5-50	5	■					
	2 pole	V7-CJ6-2	10		■				
	3 pole	V7-CJ6-3	10		■				
	10 pole	V7-CJ6-10	10		■				
50 pole	V7-CJ6-50	5		■					

Note: For full line of marking accessories see the Marking Section beginning on page N35.







Accessories (Continued)

Component	Description	Type	Catalog Number	Std. Pkg.	pg. N5	pg. N5	pg. N5	pg. N6	pg. N6
					-W3 Through	-W4 Through	-W6 Through	-W10 Through	-W16S Through
	Center Jumpers Uninsulated, screw into threaded hole in center of block	2 pole	V7-CJ7-2	10			■		
		3 pole	V7-CJ7-3	10			■		
		10 pole	V7-CJ7-10	10			■		
		40 pole	V7-CJ7-40	5			■		
		2 pole	V7-CJ8-2	10				■	
		3 pole	V7-CJ8-3	10				■	
		10 pole	V7-CJ8-10	10				■	
		40 pole	V7-CJ8-40	5				■	
		2 pole	V7-CJS11-2	10					■
		3 pole	V7-CJS11-3	10					■
		10 pole	V7-CJS11-10	10					■
		2 pole	V7-CJ14-2	10					
		3 pole	V7-CJ14-3	10					
		2 pole	V7-CJD5-2	10					
		3 pole	V7-CJD5-3	10					
		10 pole	V7-CJD5-10	10					
		50 pole	V7-CJD5-50	5					
		2 pole	V7-CJD6-2	10					
		3 pole	V7-CJD6-3	10					
10 pole	V7-CJD6-10	10							
50 pole	V7-CJD6-50	5							
10 pole	V7-CJT5-10	10							
50 pole	V7-CJT5-50	10							
	Center Jumper Links Joins two Center Jumpers		V7-CJL5	10	■				
			V7-CJL6	10		■			
			V7-CJL7	10			■		
			V7-CJL8	10				■	
			V7-CJDL6	10					
 V7-CJCW5	Center Jumper Covers		V7-CJCW5	20	■				
			V7-CJCW6	20		■	■	■	
			V7-CJCW14	10					
	Screwdriver - Specially designed for the screws on V7-W3, W4 & W6 terminals		V7-SCRDRV1	1	■	■	■		

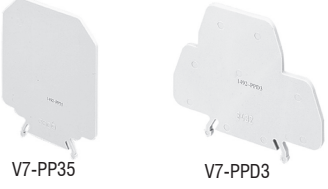
V7 Terminals

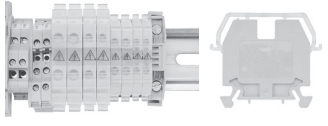
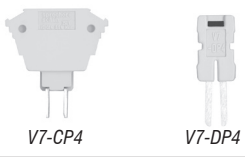
Note: For full line of marking accessories see the Marking Section beginning on page N35.

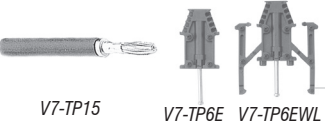
Accessories (Continued)

Component	Description	Type	Catalog Number	Std. Pkg.	pg. N5	pg. N5	pg. N5	pg. N6	pg. N6
					-W3 Through	-W4 Through	-W6 Through	-W10 Through	-W16S Through
 <p>V7-PP35 V7-PPD3</p>	Partition Plates Provides visual and electrical spacing between adjacent jumpers		V7-PP10	50			■	■	■
			V7-PP3	50	■	■			
		(shown)	V7-PP35	25					
		(shown)	V7-PPD3	50					
			V7-PPD6	50					
		Mini	V7-PPSL3	50					
		Mini	V7-PPTS3	50					
 <p>V7-SP3 V7-SPD3</p>	Separation Plate Thin, flexible plastic insulation plate provides visual and electrical isolation between adjacent center jumpers	(shown)	V7-SP3	50	■	■			
		(shown)	V7-SPD3	50					
	Electrical Warning Plates		V7-EWP5-4	10	■				
			V7-EWP6-4	10		■			
			V7-EWP7-4	10			■		
			V7-EWP8-4	10				■	
 <p>V7-CP4 V7-DP4</p>	Component Plugs Holds customer supplied diode or resistor		V7-CP4	50					
		Disconnect Plug No load isolator		V7-DP4	50				
	Fuse Plugs Holds 5x20 fuse	W/O BFI	V7-FP4	50					
		W/ 24V BFI LED	V7-FP424	50					
		W/ 240V BFI LED	V7-FP4250	50					
 <p>V7-TP15 V7-TP6E V7-TP6EWL</p>	Test Plugs Wire is soldered directly to plug	(shown)	V7-TP15	10					
			V7-TP23	10					
			V7-TP28	10		■	■	■	
		(shown)	V7-TP6E	10		■			
		(shown)	V7-TP6EWL	10		■			
 <p>V7-TA40 V7-TA285</p>	Test Plugs Adapters Accepts Banana Plug	(shown)	V7-TA285	10	■				
			V7-TA40	10		■	■	■	
	Group Marker Carrier Used for separating and identifying groups of terminals, snap-on, markable		V7-GM35	10	■	■	■	■	

V7 Terminals

Note: For full line of marking accessories see the Marking Section beginning on page N35.

Mounting Rails

Item	Description	Catalog Number
	DIN-rail - 2 meter lengths (≈6' 6") <ul style="list-style-type: none"> • Top Hat, low profile • Top Hat, high profile 	3F 3AF

Multiple Wire Connection Combinations - Stranded Copper Conductors of the Same Cross-section

Catalog Number	Wire Size AWG (mm ²)																
	#22	#20 (0.5)	#18 (0.75)	#16 (1.5)	#14 (2.5)	#12 (4)	#10 (6)	#8 (10)	#6 (16)	#4 (25)	#2 (35)	#1 (40)	1/0 (50)	2/0 (70)	3/0 (80)	300MCM (150)	500MCM (250)
Catalog Number	Number of same size wires per panel																
V7-H4,-H5,-H6,-H7	4	4	3	2	2	1											
V7-W4	4	4	3	2	2	1	1										
V7-W4P	4	4	3	2	2	1 ①											
V7-W4PTP	4	4	3	2	2	1 ①											
V7-W6	4	4	3	2	2	1	1										
V7-W10	4	4	4	4	3	2	1	1									
V7-W16S					4	3	2	2	1	1							
V7-W35 ①					3	3	3	2	2	1	1	1	1				
V7-W70 ①					5	5	5	2	2	2	2	1	1	1	1		
V7-WD6 ①			3	2	2	1	1										
V7-WD4DF	4	4	3	2	2	1											
V7-WD4DR	4	4	3	2	2	1											
V7-WD4P	4	4	3	2	2	1 ①											
V7-WD4PTP	4	4	3	2	2	1 ①											
V7-WDG4C	4	4	3	2	2	1											
V7-WDG4P...	4	4	3	2	2	1 ①											
V7-WFB10V(A)								1									
V7-WFB4	4	4	3	2	2	1											
V7-WG4	4	4	3	2	1	1											
V7-WG6	4	4	3	2	2	1	1	1									
V7-WG10S ①	4	4	4	4	3	2	1	1									
V7-WG16 ①							2	1	1	1							
V7-WG35 ①									2	1	1	1	1				
V7-WG70										2	1	1	1	1			
V7-WKD3TP	4	4	3	2	1												
V7-WKD6 ①			3	2	2	1	1										
V7-W3TW	4	4	3	2	1												
V7-WTF3, -WTS3 ②	4	4	3	2	1												
V7-W3, -WD3, -WKD3, -WR3	4	4	3	2	1												
V7-WD4, -WD4C	4	4	3	2	2	1											

① For multiple wire combinations consult factory for latest wire combination information.
 ② V7-WTF... & V7-WTS... blocks have been tested for 4 - #26 and #24 AWG wires.
 ③ These products have a maximum European wire size of 2.5 mm², yet they are UL Listed for #12 AWG wire.